



**DELUXE KITCHEN SYSTEM
WITH AUTO-IQ®**
CO905KS | Owner's Guide



IMPORTANT SAFETY INSTRUCTIONS

PLEASE READ ALL INSTRUCTIONS BEFORE USE • FOR HOUSEHOLD USE ONLY

	Read and review instructions for operation and use.
	Indicates the presence of a hazard that can cause personal injury, death, or substantial property damage if the warning included with this symbol is ignored.
	For indoor and household use only.
When using electrical appliances, basic safety precautions should always be followed, including the following:	

⚠WARNING: To reduce the risk of injury, fire, electrical shock or property damage, basic safety precautions must always be followed, including the following numbered warnings and subsequent instructions. **DO NOT** use appliance for other than intended use.

- 1 Read all instructions prior to using the appliance and its accessories.
- 2 This product is provided with a Stacked Blade Assembly and Chopping Blade Assembly. **ALWAYS** exercise care when handling blade assemblies. The blade assemblies are loose and sharp and are **NOT** locked in place in their containers. The blade assemblies are designed to be removable to facilitate cleaning and replacement if needed. **ONLY** grasp the blade assemblies by the top of the shaft. Failure to use care when handling the blade assemblies will result in a risk of laceration.
- 3 Handle the blade assemblies with care, as the blades are loose and sharp.
- 4 Before operation, ensure all utensils are removed from containers. Failure to remove utensils can cause containers to shatter and potentially result in personal injury and property damage.
- 5 **DO NOT** blend hot, effervescent, or carbonated liquids or ingredients. Doing so may cause excessive pressure buildup, resulting in risk of laceration and/or the user being burned.
- 6 Remove the Pro Extractor Blades® Assembly from the Single-Serve Cup upon completion of blending. **DO NOT** store ingredients before or after blending them in the cup with the blade assembly attached. Some foods may contain active ingredients or release gases that will expand if left in a sealed container, resulting in excessive pressure buildup that can pose a risk of laceration, burns, or property damage.
- 7 Carefully observe and follow all warnings and instructions. This unit contains electrical connections and moving parts that potentially present risk to the user.
- 8 **ALWAYS** take your time and exercise care during unpacking and appliance setup. Blades are loose and sharp. **ALWAYS** exercise care when handling blade assemblies. This appliance contains sharp, loose blades that can cause risk of laceration if mishandled.
- 9 Take inventory of all contents to ensure you have all parts needed to properly and safely operate your appliance.
- 10 Upon completion of processing, ensure the blade assembly is removed **BEFORE** emptying container's contents. Remove the blade assembly by carefully grasping the top of the shaft and lifting it from the container. Failure to remove the blade assembly before emptying the container results in a risk of laceration.
- 11 If using the pitcher's pour spout, hold the cover in place on the container or ensure lid lock is engaged when pouring to avoid risk of laceration.
- 12 **ONLY** grasp the Pro Extractor Blades Assembly by the outer perimeter of the blade assembly base. Failure to use care when handling the blade assembly will result in a risk of laceration.

IMPORTANT SAFETY INSTRUCTIONS

PLEASE READ ALL INSTRUCTIONS BEFORE USE • FOR HOUSEHOLD USE ONLY

- 13 Ensure the Stacked Blade Assembly is fully seated in the pitcher prior to use.
- 14 Turn the appliance **OFF**, then unplug the appliance from the outlet when not in use, before assembling or disassembling parts, and before cleaning. To unplug, grasp the plug by the body and pull from the outlet. **NEVER** unplug by grasping and pulling the flexible cord.
- 15 Before each use, inspect blade assemblies for damage. If a blade is bent or damage is suspected, contact SharkNinja to arrange for replacement.
- 16 **DO NOT** use this appliance outdoors. It is designed for indoor household use only.
- 17 This appliance has a polarized plug (one prong is wider than the other). To reduce the risk of electric shock, this plug will fit in a polarized outlet only one way. If the plug does not fit fully in the outlet, reverse the plug. If it still does not fit, contact a qualified electrician. **DO NOT** modify the plug in any way.
- 18 **DO NOT** operate any appliance with a damaged cord or plug, or after the appliance malfunctions or is dropped or damaged in any manner. This appliance has no user-serviceable parts. If damaged, contact SharkNinja for servicing.
- 19 This appliance has important markings on the plug blade. The entire supply cord is not suitable for replacement. If damaged, please contact SharkNinja for service.
- 20 Extension cords should **NOT** be used with this appliance.
- 21 To protect against the risk of electric shock, **DO NOT** submerge the appliance or allow the power cord to contact any form of liquid.
- 22 **DO NOT** allow the cord to hang over the edges of tables or counters. The cord may become snagged and pull the appliance off the work surface.
- 23 **DO NOT** allow the unit or the cord to contact hot surfaces, including stoves and other heating appliances.
- 24 **ALWAYS** use the appliance on a dry and level surface.
- 25 **DO NOT** allow children to operate this appliance or use as a toy. Close supervision is necessary when any appliance is used near children.
- 26 This appliance is **NOT** intended to be used by people with reduced physical, sensory, or mental capabilities, or lack of experience and knowledge, unless they have been given supervision or instruction concerning use of the appliance by a person responsible for their safety.
- 27 **ONLY** use attachments and accessories that are provided with the product or are recommended by SharkNinja. The use of attachments, including canning jars, not recommended or sold by SharkNinja may cause fire, electric shock, or injury.
- 28 **NEVER** place a blade assembly on the motor base without it first being attached to its corresponding container (pitcher, cup, or processor bowl) with the lid also in place.
- 29 Keep hands, hair, and clothing out of the container when loading and operating.
- 30 During operation and handling of the appliance, avoid contact with moving parts.
- 31 **DO NOT** fill containers past the **MAX FILL** or **MAX LIQUID** lines to avoid risk of injury due to damage to the lids or containers.
- 32 **DO NOT** operate the appliance with an empty container.
- 33 **DO NOT** microwave any containers or accessories provided with the appliance.
- 34 **NEVER** leave the appliance unattended while in use.
- 35 **DO NOT** process dry ingredients with the Single-Serve Cup and Pro Extractor Blades® Assembly, the pitcher and Stacked Blade Assembly, or the processor bowl and Chopping Blade Assembly.
- 36 **DO NOT** perform grinding operations with the Single-Serve Cup and Pro Extractor Blades Assembly, the pitcher and Stacked Blade Assembly, or the processor bowl and Chopping Blade Assembly.
- 37 **NEVER** operate the appliance without lids and caps in place. **DO NOT** attempt to defeat the interlock mechanism. Ensure the container and lid are properly installed before operation.
- 38 Keep hands and utensils away from moving blades while processing food to reduce the risk of severe personal injury or damage to the blender. A scraper may be used **ONLY** when the blender is not running.
- 39 If you find unmixed ingredients sticking to the sides of the cup, stop the appliance, remove the blade assembly, and use a scraper to dislodge ingredients.

- 40 **DO NOT** open the pitcher's pour spout cap while blender is operating.
- 41 If you find unmixed ingredients sticking to the sides of the pitcher, stop the appliance, remove the lid, and use a spatula to dislodge ingredients. **NEVER** insert your hands into the pitcher, as you may contact one of the blades and experience a laceration.
- 42 **DO NOT** attempt to remove the container or lid from the motor base while the blade assembly is still spinning. Allow the appliance to come to a complete stop before removing lids and containers.
- 43 If the appliance overheats, a thermal switch will activate and temporarily disable the motor. To reset, unplug the appliance and allow it to cool for approximately 30 minutes before using again.
- 44 **DO NOT** expose the containers and accessories to extreme temperature changes. They may experience damage.
- 45 The maximum wattage rating for this appliance is based on the configuration of the Pro Extractor Blades® Assembly and Single-Serve Cup. Other configurations may draw less power or current.
- 46 **DO NOT** submerge the motor base or control panel in water or other liquids. **DO NOT** spray motor base or control panel with any liquid.
- 47 **DO NOT** attempt to sharpen blades.
- 48 Turn off the appliance and unplug the motor base before cleaning.
- 49 Unit is intended to create a dough ball. It is **NOT** intended to continuously knead. After dough ball forms, additional kneading should be done by hand on a work surface. If the unit moves excessively on the work surface, remove the dough ball and knead by hand.

SAVE THESE INSTRUCTIONS

PARTS

- A Pitcher Lid
- B Precision Processor® Bowl Feed Chute Lid and Pusher
- C (2) Spout Lids
- D 88-oz.* Total Crushing® Pitcher
- E 72-oz. Precision Processor Bowl
- F (2) 24-oz. Single-Serve Cups
- G Motor Base (attached power cord not shown)
- H Stacked Blade Assembly
- I Chopping Blade Assembly
- J Dough Blade Assembly
- K Pro Extractor Blades® Assembly
- L Reversible Slicing/Shredding Disc
- M Grating Disc
- N Spindle

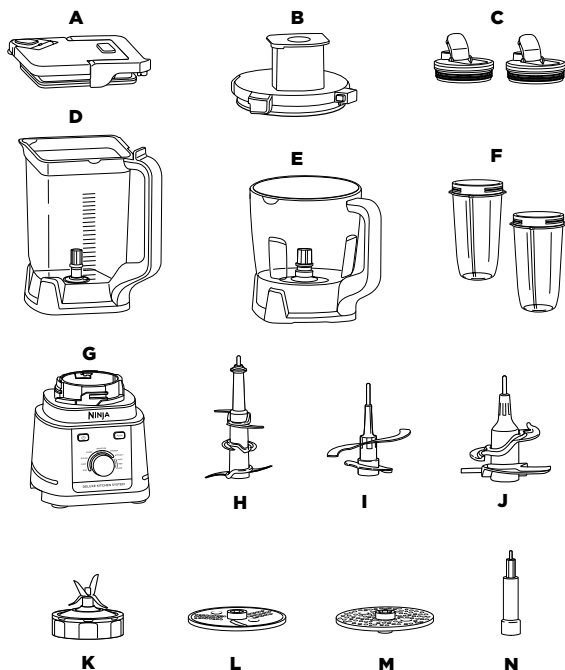

*80-oz. max liquid capacity.

There are a variety of accessories that are compatible with this blender series.

To purchase more accessories and find great recipes, visit ninjakitchen.com.

BEFORE FIRST USE

IMPORTANT

- Review all warnings at the beginning of this Owner's Guide before proceeding.

⚠WARNING: The Stacked Blade Assembly and Chopping Blade Assembly are **NOT** locked in place in the pitcher. Handle the Stacked Blade Assembly and Chopping Blade Assembly by grasping the top of the shaft to avoid risk of laceration.

- 1 Remove all packaging materials from the unit. Exercise care when unpacking the Stacked Blade Assembly, Chopping Blade Assembly, and Pro Extractor Blades Assembly, as the blades are loose and sharp.
- 2 Handle the Pro Extractor Blades Assembly by grasping around the perimeter of the blade assembly base.
- 3 Wash containers, lids, and blade assemblies in warm, soapy water using a dishwashing utensil with a handle to avoid direct contact with the blades. Exercise care when handling blade assemblies, as the blades are loose and sharp.
- 4 Thoroughly rinse and air-dry all parts.
- 5 Wipe control panel with a soft cloth. Allow it to dry completely before using.

NOTE: All attachments are BPA free. Accessories are top-rack dishwasher safe and should **NOT** be cleaned with a heated dry cycle. Ensure blade assemblies and lids are removed from the containers before placing in the dishwasher. Exercise care when handling blade assemblies to avoid risk of laceration.

FEATURES

Use the Power button to turn the unit on or off.

AUTO-IQ® PROGRAMS

Intelligent preset programs combine unique blending and pausing patterns that do the work for you. Once a preset program is selected, it will start immediately and automatically stop when blending is complete. To stop blending before the end of the program, press the currently active button again.



AUTO-IQ PROGRAMS FOR THE TOTAL CRUSHING® PITCHER

SMOOTHIE: Make a batch of super-smooth, sippable drinks and shakes from fresh or frozen fruit, liquids, and ice.

FROZEN: Turn ice, juices, and fruit into expertly blended frozen drinks.



AUTO-IQ PROGRAMS FOR THE PRECISION PROCESSOR® BOWL

DISC: Slice, shred, or grate a variety of ingredients, from fresh vegetables to cheeses.

CHOP: Timed pulses and pauses to give you consistent chopping results.

DOUGH: Ideal for creating delicious dough for pizza, bread, and baked goods like cookies.

PUREE: Create anything from silky-smooth sauces to the perfect hummus.



AUTO-IQ PROGRAMS FOR THE SINGLE-SERVE CUP

PUREE: Create anything from silky-smooth sauces to the perfect hummus.

SMOOTHIE: Make super-smooth, sippable drinks and shakes in your cup, using fresh or frozen fruit, liquids, and ice.

FROZEN: Turn ice, juices, and fruit into expertly blended frozen drinks.

EXTRACT: Ideal for tough, leafy, or fibrous whole fruits and vegetables, including their skins, seeds, and stems.



MANUAL PROGRAMS

HIGH, MEDIUM, and LOW: When selected, each of these speeds runs continuously for 60 seconds. Press the currently active button again to stop the program sooner. They do not work in conjunction with any Auto-iQ programs.

PULSE: Offers greater control of pulsing and blending. Operates only when PULSE is pressed. Use short presses for short pulses and long presses for long pulses.

NOTE: The unit can detect which container is installed on the motor base. Only the functions available for a particular container will illuminate on the control panel.

USING THE TOTAL CRUSHING® PITCHER

IMPORTANT:

- Review all warnings at the beginning of this Owner's Guide before proceeding.
- As a safety feature, if the pitcher and lid are not properly installed, the timer will display "... .." and the motor will be disabled. If this happens, repeat **step 5** on this page. When the pitcher and lid are properly installed, the program button LEDs will illuminate, indicating the appliance is ready to use.

⚠WARNING: The Stacked Blade Assembly is loose and sharp and NOT locked in place. If using the pour spout, ensure the lid is fully locked onto the blender pitcher. If pouring with the lid removed, carefully remove the Stacked Blade Assembly first, holding it by the shaft. Failure to do so will result in a risk of laceration.

NOTE:

- If the unit is plugged in and powered on, but the pitcher is not installed, the LEDs on the control panel will flash.
- **DO NOT** add ingredients before completing installation of the Stacked Blade Assembly.
- If the Stacked Blade Assembly is not fully seated, you will not be able to install and lock the lid.
- The pitcher lid handle will not fold down unless the lid is attached to the pitcher.
- **DO NOT** process or grind dry ingredients.

1 Plug in motor base and place on a clean, dry, level surface such as a countertop or table.

2 Lower the Total Crushing® Pitcher onto the motor base. The handle should be aligned slightly to the right and the pitcher should be oriented so the **LOCK** symbols are visible on the motor base. Rotate the pitcher clockwise until it clicks into place.

3 Exercising care, grasp the Stacked Blade Assembly by the top of the shaft and place it onto the drive gear inside the pitcher. Note that the blade assembly will fit loosely onto the drive gear.

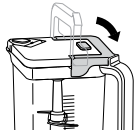
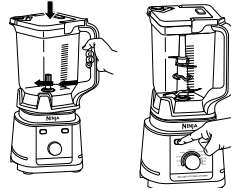

4 Add ingredients to the pitcher. **DO NOT** add ingredients past the **MAX LIQUID** line.

5 Place the lid on the pitcher. Press down on the handle until it clicks into place. Once the lid is locked in place, press the Power button to turn unit on. The available program buttons will illuminate and the unit will be ready for use.

6a If using an Auto-iQ® program, first use the dial to select the program that best suits your recipe. To start, press the dial. The preset feature will automatically stop at the end of the program. To stop the unit at any time, press the dial again.

6b If using a manual program, use the dial to select your desired speed. To start, press the dial. Once the ingredients have reached your desired consistency, press the dial again or wait 60 seconds for the unit to come to a complete stop.

7 To remove the pitcher from the motor base, turn the pitcher counterclockwise and then lift up.

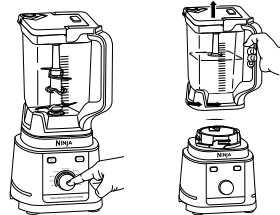

8a To pour out thinner mixtures, ensure the lid is locked in place, then open the pour spout cap.

8b For thicker mixtures that cannot be emptied through the pour spout, remove the lid and Stacked Blade Assembly before pouring. To remove the lid, press the **RELEASE** button and lift the handle. To remove the blade assembly, carefully grasp it by the top of the shaft and pull straight up. The pitcher can then be emptied.

9 Turn the unit off by pressing the Power button. Unplug the unit when finished. Refer to the Care & Maintenance section for cleaning and storage instructions.

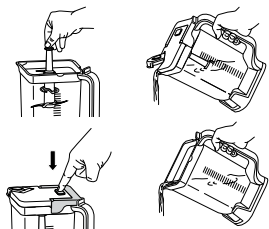

USING THE SINGLE-SERVE CUP

IMPORTANT: Review all warnings at the beginning of this Owner's Guide before proceeding.

⚠WARNING:

- Handle the Pro Extractor Blades® Assembly with care, as the blades are sharp.
- Remove utensils prior to processing. Failure to remove may cause the Single-Serve Cup to be damaged or to shatter, which may cause personal injury.
- **DO NOT** blend hot, effervescent, or carbonated liquids. Doing so may cause excessive pressure buildup, resulting in risk of laceration and/or the user being burned.
- **DO NOT** process or grind dry ingredients.
- Remove the Pro Extractor Blades Assembly from the Single-Serve Cup upon completion of blending. **DO NOT** store ingredients before or after blending them in the cup with the blade assembly attached. Some foods may contain active ingredients or release gases that will expand if left in a sealed container, resulting in excessive pressure buildup that can pose a risk of injury.

1 Plug in motor base and place on a clean, dry, level surface such as a countertop or table.

2 Add ingredients to the Single-Serve Cup. **DO NOT** add ingredients past the **MAX LIQUID** line on the cup.

3 Install the Pro Extractor Blades Assembly onto the top of the cup. Twist the lid clockwise until it's sealed tightly.

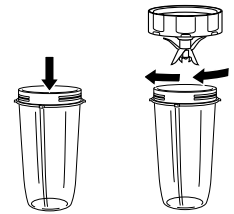

4 Turn the cup upside down and install on the motor base. Align the tabs on the cup with the slots on the base, then rotate cup clockwise until it clicks into place. Once the cup is locked in place, press the Power button to turn unit on. The available program buttons will illuminate and the unit will be ready for use.



5a If using an Auto-iQ® program, first use the dial to select the program that best suits your recipe. To start, press the dial. The preset feature will automatically stop at the end of the program. To stop the unit at any time, press the dial again.

5b If using a manual program, use the dial to select your desired speed. To start, press the dial. Once the ingredients have reached your desired consistency, press the dial again or wait 60 seconds for the unit to come to a complete stop.



6 To remove the cup from the motor base, turn the cup counterclockwise and then lift up.

7 Remove the Pro Extractor Blades Assembly by twisting the cap counterclockwise. **DO NOT** store blended contents with Pro Extractor Blades Assembly attached. Exercise care when handling the blade assembly, as the blades are sharp.

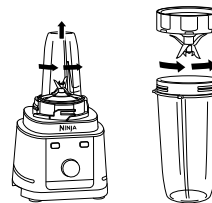

8 Turn the unit off by pressing the Power button. Unplug the unit when finished. Refer to the Care & Maintenance section for cleaning and storage instructions.

9 To enjoy your drink on the go, place the Spout Lid onto the cup and twist lid clockwise until firmly sealed. For storing ingredients in the cup, use only the Spout Lid to cover.

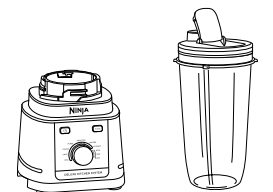

USING THE PRECISION PROCESSOR® BOWL BLADE ASSEMBLIES

IMPORTANT:

- Review all warnings at the beginning of this Owner's Guide before proceeding.
- As a safety feature, if the blade assembly is not fully seated, you will not be able to install and lock the lid.

⚠ WARNING: Chopping Blade Assembly is loose, sharp, and NOT locked in place. Before removing blended ingredients from the bowl, carefully remove the blade assembly first, holding it by the shaft. Failure to do so will result in a risk of laceration.

NOTE:

- **DO NOT** process or grind dry ingredients.
- **DO NOT** add ingredients before completing installation of the blade assembly.
- Follow the same instructions to install the Dough Blade Assembly as the Chopping Blade Assembly.

- 1 Plug in motor base and place on a clean, dry, level surface such as a countertop or table.
- 2 Lower the Precision Processor Bowl onto the motor base and rotate clockwise until it clicks into place.
- 3 To install the blade assembly, exercise care and grasp the Chopping Blade Assembly by the top of the shaft and place it onto the drive gear inside the bowl. Note that the Chopping Blade Assembly will fit loosely onto the drive gear.

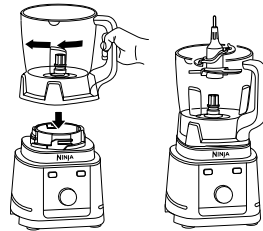

- 4 Add ingredients to the bowl, making sure not to exceed the **MAX FILL** line.
- 5 Place the lid on the bowl and turn clockwise until you hear a click, indicating the lid is locked in place. Once the lid is locked in place, press the Power button to turn unit on. The available program buttons will illuminate and the unit will be ready for use.

- 6a If using an Auto-iQ® program, first use the dial to select the program that best suits your recipe. To start, press the dial. The preset feature will automatically stop the unit at the end of the program. To stop the unit at any time, press the dial again.
- 6b If using a manual program, use the dial to select your desired speed. To start, press the dial. Once the ingredients have reached your desired consistency, press the dial again or wait 60 seconds for the unit to come to a complete stop.
- 7 To remove the bowl from the motor base, turn the bowl counterclockwise and then lift up.

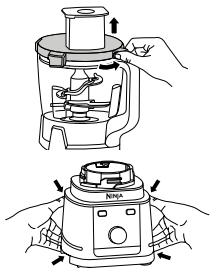
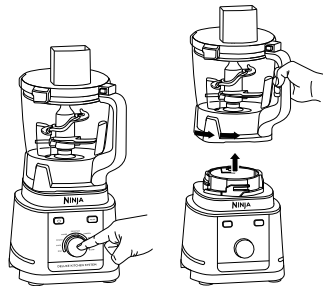

- 8 When finished, press the button on the lid near the handle to unlock, then turn counterclockwise and lift up from the bowl. Always remove the Chopping Blade Assembly before emptying the ingredients from the bowl. To remove the Chopping Blade Assembly, carefully grasp it by the top of the shaft and lift it out of the bowl.
- 9 Turn the unit off by pressing the Power button. Unplug the unit when finished. Refer to the Care & Maintenance section for cleaning and storage instructions.

USING THE REVERSIBLE SLICING/SHREDDING & GRATING DISC

NOTE:

- The Slicing/Shredding Disc is reversible. Use the side labeled "Slicer" for slicing. Carefully flip the disc over to the side labeled "Shredder" for shredding.
- The feed chute lid features a pusher to guide food through the chute.
- Follow the same instructions to install the Grating Disc as the Reversible Slicing/Shredding Disc.

- 1 Plug in motor base and place on a clean, dry, level surface such as a countertop or table.
- 2 Lower the Precision Processor® Bowl onto the motor base and rotate clockwise until it clicks into place.
- 3 To install the Reversible Slicing/Shredding Disc, place the disc spindle onto the drive gear inside the bowl. Then, use the finger holes to grasp the Reversible Slicing/Shredding Disc and place it over the spindle, with the side you would like to use facing up.

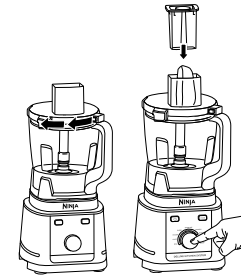
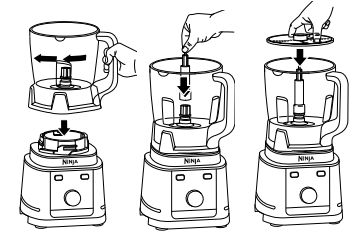

- 4 Place the feed chute lid on the bowl and turn clockwise until you hear a click, indicating the lid is locked in place. Once the lid is locked in place, press the Power button to turn unit on. The available program buttons will illuminate and the unit will be ready for use.
 - 5a If using the Auto-iQ® program, DISC, use the dial to select. The disc will automatically stop spinning at the end of the program.
 - 5b If using a manual program, use the dial to select your desired speed (LOW recommended).

- 6 Press the dial to begin the program. Add the prepped ingredients you want to slice or shred through the feed chute on the lid. Use the pusher to help guide the ingredients through the feed chute. The program will automatically stop the unit once completed. To stop the unit at any time, press the dial again.
- 7 To remove the lid, press the button on the feed chute lid near the handle to unlock, then turn the lid counterclockwise. Lift the lid from the bowl.
- 8 Using the finger holes, carefully lift the disc out of the bowl. Then, grasp the spindle by the top of the shaft and lift it out of the bowl.

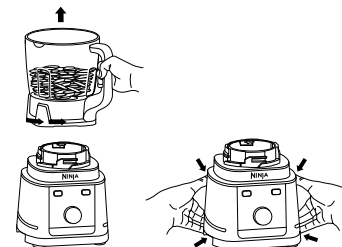
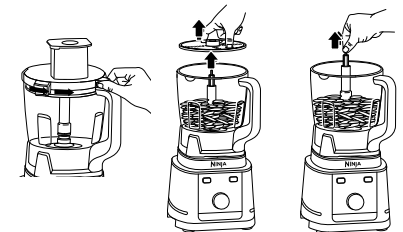

- 9 To remove the bowl from the motor base, turn the bowl counterclockwise and then lift up.
- 10 Turn the unit off by pressing the Power button. Unplug the unit when finished. Refer to the Care & Maintenance section for cleaning and storage instructions.

CARE & MAINTENANCE

CLEANING

Separate all parts. Wash all containers in warm, soapy water with a soft cloth.

• Hand-Washing

Wash blade assemblies in warm, soapy water using a dishwashing utensil with a handle to avoid direct contact with the blades. Exercise care when handling blade assemblies as the blades are loose and sharp. Thoroughly rinse and air-dry all parts.

• Dishwasher

All parts except the motor base are top-rack dishwasher safe and should **NOT** be cleaned with a heated dry cycle. Ensure the blade assembly is removed from the container before placing in the dishwasher. Exercise care when handling blade assembly.

• Motor Base

Turn off the unit and unplug the motor base before cleaning. Wipe motor base with a clean, damp cloth. **DO NOT** use abrasive cloths, pads, or brushes to clean the base.

STORING

Wrap the power cord around the cord wrap on the back of the motor base. Store the unit upright and store all blade assemblies inside or attached to their respective containers with their lids locked in place.

DO NOT store blended or unblended ingredients in the Single-Serve Cup with the Pro Extractor Blades® assembly attached.

DO NOT stack items on top of the containers. Store any remaining attachments alongside the unit or in a cabinet where they will not be damaged or create a hazard.

RESETTING THE MOTOR

This unit features a unique safety system that prevents damage to the motor and drive system should you inadvertently overload it. If the unit is overloaded, the motor will be temporarily disabled. Should this occur, follow the reset procedure below.

- 1 Unplug the unit from the electrical outlet.
- 2 Allow the unit to cool for approximately 15 minutes.
- 3 Remove the container's lid and blade assembly. Empty the container and ensure no ingredients are jamming the blade assembly.

IMPORTANT: Ensure that maximum capacities are not exceeded. This is the most typical cause of appliance overload.

If your unit needs servicing, please call Customer Service at 1-877-646-5288. So we may better assist you, please register your product online at [registryourninja.com](https://www.ninjablender.com) and have the product on hand when you call.

ORDERING REPLACEMENT PARTS

To order additional parts and attachments, visit [ninjaaccessories.com](https://www.ninjaaccessories.com).

PRODUCT REGISTRATION

Please visit [registryourninja.com](https://www.ninjablender.com) to register your new Ninja® product within ten (10) days of purchase. You will be asked to provide the store name, date of purchase, and model number along with your name and address. The registration will enable us to contact you in the unlikely event of a product safety notification. By registering, you acknowledge you have read and understood the instructions for use and warnings set forth in the accompanying instructions.

TROUBLESHOOTING GUIDE

⚠WARNING: To reduce the risk of shock and unintended operation, turn power off and unplug unit before troubleshooting.

Display will read “- -” once connected to power.

- Place container on base and rotate it clockwise until container clicks into place. Press the Power button  to turn unit on, and the available programs will illuminate indicating the unit is ready for use.

Display reads “E1”.

- If the display reads “E1”, unplug the unit from the electrical outlet and allow it to cool for 15 minutes. Remove the container's lid and blade assembly, and empty the contents to ensure no ingredients are jamming the blade assembly.

Lid/Pro Extractor Blades® Assembly is hard to install on the cup.

- Set the cup on a level surface. Carefully place the lid or Pro Extractor Blades Assembly on the top of the cup and align the threads so the lid/Pro Extractor Blades Assembly sits flat on the cup. Twist clockwise until you have a tight seal.

Unit doesn't mix well; ingredients get stuck.

- Using the Auto-iQ® programs is the easiest way to achieve great results. The pulses and pauses allow the ingredients to settle toward the blade assembly. If ingredients are routinely getting stuck, adding some liquid will usually help.
- When filling the cup, start with fresh fruit or veggies, then leafy greens or herbs. Next add liquids or yogurt, then seeds, powders, or nut butters. Finally, add ice or frozen ingredients.

Motor base won't stick to counter or tabletop.

- Make sure surface and suction feet are wiped clean. Suction feet will only stick to smooth surfaces.
- Suction feet will not stick on some surfaces such as wood, tile, and non-polished finishes.
- **DO NOT** attempt to use unit when the motor base is stuck to a surface that is not secure (cutting board, platter, plates, etc.).

Unit is difficult to remove from counter for storage.

- Place your hands underneath both sides of the motor base and gently pull the unit up and toward you.

Unit displays a blinking “... ..” message.

- The unit can detect which container is on the motor base. You may be trying to use a program that is not designed for the container you have installed. The programs will light up, indicating which programs are available for each container.

The unit doesn't create snow from solid ice.

- **DO NOT** use ice that has been sitting out or has started to melt. Use ice straight from the freezer.
- Start with a few pulses and then use a continuous blending cycle.

Food is not evenly chopped or processed.

- For best results when chopping, cut pieces of ingredients in a uniform size and don't overfill the Precision Processor® Bowl.

- When prepping vegetables, cut both ends off ingredients and remove any outer peels or skins. Cut ingredients such as carrots, cucumbers, celery, and zucchini in 2-inch pieces, and broccoli or cauliflower florets in 1-inch pieces. Cut ingredients such as onions in quarters.

- When prepping meat, trim excess fat and connective tissue. Cut meat in 2-inch cubes.

The pitcher lid handle will not fold down.

- If lid is not attached to the pitcher, the handle will not fold down. For storage, place the lid on the pitcher and press down on the handle until it clicks into place.

Unit moves on counter while blending.

- Make sure the surface and feet of the unit are clean and dry.

ONE (1) YEAR LIMITED WARRANTY

NJA_1_YR_IB_LMTD_WRNTY_US_ENG

The One (1) Year Limited Warranty applies to purchases made from authorized retailers of **SharkNinja Operating LLC**. Warranty coverage applies to the original owner and to the original product only and is not transferable.

SharkNinja warrants that the unit shall be free from defects in material and workmanship for a period of one (1) year from the date of purchase when it is used under normal household conditions and maintained according to the requirements outlined in the Owner's Guide, subject to the following conditions and exclusions:

What is covered by this warranty?

1. The original unit and/or non-wearable parts deemed defective, in SharkNinja's sole discretion, will be repaired or replaced up to one (1) year from the original purchase date.
2. In the event a replacement unit is issued, the warranty coverage ends six (6) months following the receipt date of the replacement unit or the remainder of the existing warranty, whichever is later. SharkNinja reserves the right to replace the unit with one of equal or greater value.

What is not covered by this warranty?

1. Normal wear and tear of wearable parts (such as blending vessels, lids, cups, blades, blender bases, removable pots, racks, pans, etc.), which require regular maintenance and/or replacement to ensure the proper functioning of your unit, are not covered by this warranty. Replacement parts are available for purchase at ninjaaccessories.com.
2. Any unit that has been tampered with or used for commercial purposes.
3. Damage caused by misuse, abuse, negligent handling, failure to perform required maintenance (e.g., failure to keep the well of the motor base clear of food spills and other debris), or damage due to mishandling in transit.
4. Consequential and incidental damages.
5. Defects caused by repair persons not authorized by SharkNinja. These defects include damages caused in the process of shipping, altering, or repairing the SharkNinja product (or any of its parts) when the repair is performed by a repair person not authorized by SharkNinja.
6. Products purchased, used, or operated outside North America.

How to get service

If your appliance fails to operate properly while in use under normal household conditions within the warranty period, visit ninjakitchen.com/support for product care and maintenance self-help. Our Customer Service Specialists are also available at **1-877-646-5288** to assist with product support and warranty service options, including the possibility of upgrading to our VIP warranty service options for select product categories. So we may better assist you, please register your product online at registeryourninja.com and have the product on hand when you call.

SharkNinja will cover the cost for the customer to send in the unit to us for repair or replacement. A fee of \$20.95 (subject to change) will be charged when SharkNinja ships the repaired or replacement unit.

How to initiate a warranty claim

You must call **1-877-646-5288** to initiate a warranty claim. You will need the receipt as proof of purchase. We also ask that you register your product online at registeryourninja.com and have the product on hand when you call, so we may better assist you. A Customer Service Specialist will provide you with return and packing instruction information.

How state law applies

This warranty gives you specific legal rights, and you also may have other rights that vary from state to state. Some states do not permit the exclusion or limitation of incidental or consequential damages, so the above may not apply to you.



REGISTER YOUR PURCHASE



registeryourninja.com



Scan QR code using mobile device

RECORD THIS INFORMATION

Model Number: _____

Serial Number: _____

Date of Purchase: _____
(Keep receipt)

Store of Purchase: _____

TECHNICAL SPECIFICATIONS

Voltage: 120V~, 60Hz

Power: 1200 Watts

SharkNinja Operating LLC
US: Needham, MA 02494
CAN: Ville St-Laurent, QC H4S 1A7
1-877-646-5288
ninjakitchen.com

Illustrations may differ from actual product. We are constantly striving to improve our products, therefore the specifications contained herein are subject to change without notice.

AUTO-IQ, NINJA, PRECISION PROCESSOR, PRO EXTRACTOR BLADES, and TOTAL CRUSHING are registered trademarks of SharkNinja Operating LLC.

This product may be covered by one or more U.S. patents. See sharkninja.com/patents for more information.

© 2023 SharkNinja Operating LLC

CO905KS_IB_MP_Mv4



@ninjakitchen