

THANK YOU

for purchasing the Ninja Sizzle™ Grill and Griddle



REGISTER YOUR PURCHASE



registeryourninja.com



Scan QR code using mobile device

RECORD THIS INFORMATION

Model Number: _____

Serial Number: _____

Date of Purchase: _____
(Keep receipt)

Store of Purchase: _____

TECHNICAL SPECIFICATIONS

Voltage: 120V~, 60Hz

Watts: 1450W

SharkNinja Operating LLC

US: Needham, MA 02494

1-877-646-5288

ninjakitchen.com

Illustrations may differ from actual product. We are constantly striving to improve our products, therefore the specifications contained herein are subject to change without notice.

NINJA is a registered trademark of SharkNinja Operating LLC.

NINJA SIZZLE is a trademark of SharkNinja Operating LLC.

This product may be covered by one or more U.S. patents. See sharkninja.com/patents for more information.

© 2024 SharkNinja Operating LLC.

GR101A_IB_MP_Mv4_240202



@ninjakitchen







NINJA SIZZLE™ GRILL AND GRIDDLE GR101A | Owner's Guide



IMPORTANT SAFETY INSTRUCTIONS

INDOOR HOUSEHOLD USE ONLY. READ ALL INSTRUCTIONS BEFORE USE

	Read and review instructions to understand operation and use of product.
	Indicates the presence of a hazard that can cause personal injury, death or substantial property damage if the warning included with this symbol is ignored.
	Avoid contact with hot surface. Always use hand protection to avoid burns.
	For indoor and household use only.

⚠ WARNING To reduce the risk of injury, fire, electrical shock or property damage, basic safety precautions must always be followed, including the following numbered warnings and subsequent instructions. Do not use appliance for other than intended use.

- 1 To eliminate a choking hazard for young children, discard all packaging materials immediately upon unpacking.
- 2 This appliance can be used by persons with reduced physical, sensory or mental capabilities or lack of experience and knowledge if they have been given supervision or instruction concerning use of the appliance in a safe way and understand the hazards involved.
- 3 Keep the appliance and its cord out of reach of children. **DO NOT** allow the appliance to be used by children. Close supervision is necessary when used near children.
- 4 This appliance is for household use only. **DO NOT** use this appliance for anything other than its intended use. **DO NOT** use in moving vehicles or boats. **DO NOT** use outdoors. Misuse may cause injury.
- 5 To reduce the risk of fire, **DO NOT** place on or near a hot gas or electric burner or in a heated oven.
- 6 Ensure the surface is level, clean and dry. **DO NOT** place the appliance near the edge of a countertop during operation.
- 7 **ALWAYS** ensure the appliance is properly assembled before use. **DO NOT** place appliance on or near a gas oven or electric stovetop, or in a heated oven.
- 8 When using this appliance, provide at least 6 inches (15.25 cm) of space above and on all sides for air circulation.
- 9 **DO NOT** use an extension cord. A short power-supply cord is used to reduce the risk of children grabbing the cord or becoming entangled and to reduce the risk of people tripping over a longer cord.
- 10 To protect against electrical shock **DO NOT** immerse cord, plugs, or main unit housing in water or other liquid.
- 11 **DO NOT** use the appliance if there is damage to the power cord or plug. Regularly inspect the appliance and power cord. If the appliance malfunctions or has been damaged in any way, immediately stop use and call Customer Service.
- 12 **NEVER** use outlet below countertop surface.
- 13 **DO NOT** place appliance and let cord hang over edges of tables, counters or touch hot surfaces.
- 14 Only use recommended accessories included with this appliance or authorized by SharkNinja. The use of accessories or attachments not recommended by SharkNinja may cause a risk of fire or injury.
- 15 Before placing any accessory into the cooker, ensure they are clean and dry.
- 16 **DO NOT** move the appliance when in use.

IMPORTANT SAFETY INSTRUCTIONS

PLEASE READ CAREFULLY BEFORE USE • FOR HOUSEHOLD USE ONLY

- 17 **DO NOT** touch hot surfaces. Appliance surfaces are hot during and after operation. To prevent burns or personal injury, **ALWAYS** use protective hot pads or insulated oven mitts and use available handles and knobs.
- 18 **DO NOT** touch accessories during or immediately after cooking. The grill plate becomes extremely hot during the cooking process. Avoid physical contact while removing the accessory from the appliance. To prevent burns or personal injury **ALWAYS** use care when interfacing with product. Recommend use of long-handled utensil and protective hot pads or insulated oven mitts.
- 19 **DO NOT** use this appliance for deep-frying.
- 20 To prevent possible illness, **ALWAYS** use an external food thermometer to check that your food is cooked to the recommended temperatures.
- 21 Should a grease fire occur or the unit emits black smoke, unplug immediately. Wait for smoking to stop before removing any cooking accessories.
- 22 Please refer to the Cleaning & Maintenance section for regular maintenance of the appliance.
- 23 To disconnect, turn unit to "OFF," then unplug from socket when not in use and before cleaning.
- 24 Allow to cool before cleaning, disassembling, putting in or taking off parts, or storing.
- 25 **DO NOT** clean with metal scouring pads. Pieces can break off the pad and touch electrical parts, creating a risk of electric shock.
- 26 Cleaning and user maintenance shall not be done by children.
- 27 Extreme caution must be used when moving an appliance containing hot oil or other hot liquids.

SAVE THESE INSTRUCTIONS.

GETTING TO KNOW THE NINJA SIZZLE™ GRILL AND GRIDDLE

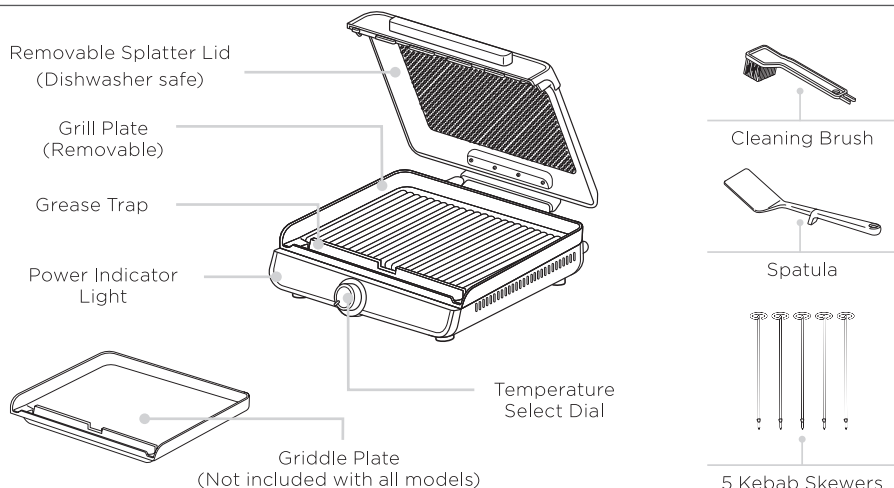

BEFORE FIRST USE

- 1 Remove and discard any packaging material, stickers, and tape from the unit.
- 2 Remove all accessories from the package and carefully read the manual before use. Please pay particular attention to operational instructions, warnings, and important safeguards to avoid any injury or property damage.
- 3 Wash the grill and griddle plates with a damp, soapy cloth, then wipe with a clean, damp cloth and dry thoroughly. The splatter lid, kebab skewers, cleaning brush, and spatula are dishwasher safe. **NEVER** submerge the main unit in water.
- 4 We recommend turning the unit on and running it on 400°F for 10 minutes without adding food. Make sure the area is well ventilated. This removes any packaging residue and odor traces that may be present. This is completely safe and not detrimental to the performance of the grill.

HOW TO HAVE A VIRTUALLY SMOKE-FREE EXPERIENCE

Always use the recommended grill settings. Our chef-designed temperature settings maximize grill flavors and textures while minimizing smoke.

325°F	375°F	400°F	500°F
When using thicker barbecue sauces Burgers	Frozen meats		
	Marinated proteins or proteins with sauce	Hotdogs	Veggies
	Bacon	Pancakes	Fruit
	Steaks	Fried eggs	Fresh/Frozen seafood
	Chicken	Grilled cheese	
	Salmon		

If using oil or fat during the cooking process, we recommend using oils with high smoke points. For best results, Canola, Refined Coconut, Avocado, Vegetable, or Grapeseed oils are recommended. Olive Oil, Butter, Margarine, or aerosol cooking sprays are NOT recommended.

COOKING WITH THE NINJA SIZZLE™ GRILL AND GRIDDLE

- 1 To install the grill or griddle plate, position it over the base with the grease trap toward the front. Place the cooking plate down ensuring the sides align with the exterior of the base.
- 2 Make sure the unit is plugged in, then turn the dial to the desired temperature. The power indicator light will illuminate.
- 3 Allow the grill to preheat with the lid closed for 7 minutes before cooking.
- 4 When preheat is complete, open the lid and place ingredients on the grill plate.
- 5 Once ingredients are cooked to the desired doneness, remove from the grill and turn the dial until it clicks into the "OFF" position. The power indicator light will turn off.
- 6 To remove the grill or griddle plate for cleaning, ensure the dial is in the "OFF" position, and the unit is unplugged and has had sufficient time to cool. Open the lid and lift the cooking plate straight up by grabbing the vertical walls along the edge of the cooking surface.

NOTE: Ninja Sizzle Grill and Griddle can be used with the lid open or closed.

NOTE: The griddle plate is not included on all models.

INSTALLING AND REMOVING THE SPLATTER LID

- 1 After allowing the unit to cool, remove the lid by opening it until it is approximately vertical (**Figure 1**). Then lift the lid straight up out of the hinge base.
- 2 To install the lid, hold it vertically with the handle facing up and the hinge pivots over the hinge base (**Figure 2**). Ensure that the flat sections of the hinge pivots are oriented vertically (**Figure 3**). Lower the lid hinge pivots into the hinge base, then close the lid.

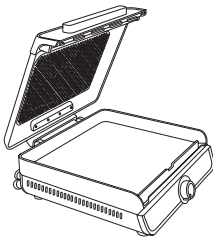

Figure 1

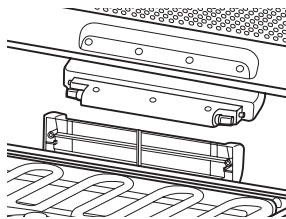

Figure 2

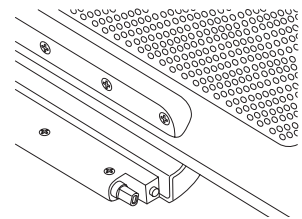

Figure 3

CLEANING YOUR GRILL AND GRIDDLE

The unit should be cleaned thoroughly after each use. Always let the appliance cool before cleaning.

- 1** Unplug the unit from the wall outlet before cleaning. Keep the lid open after removing your food to allow the unit to cool quicker.
- 2** To prolong the nonstick coating of the grill and griddle plates, we recommend hand-washing in warm, soapy water. If hand-washing, we recommend using the included cleaning brush to help wash the parts. Air-dry or towel-dry all parts after hand-washing. The splatter lid, kebab skewers, grill brush, and spatula are dishwasher safe.

- 3** If food residue or grease is stuck on the grill plate, griddle plate, splatter lid, or any other removable part, soak in warm, soapy water. After soaking, use the included cleaning brush to clean each part.
- 4** To clean the base heating unit of the grill, use a damp, soapy cloth, then wipe with a clean, damp cloth and dry thoroughly.

NOTE: NEVER use abrasive tools or cleaners. **NEVER** immerse the main unit in water or any other liquid. Do not place in dishwasher.

TROUBLESHOOTING GUIDE

- **Why is the unit emitting smoke?**

When using the Grill function, always select the recommended temperature setting. Recommended settings can be found in the Quick Start Guide and in the Inspiration Guide. Make sure the splatter shield is installed.

- **Why did a circuit breaker trip while using the unit?**

The unit uses 1450 watts of power, so it must be plugged into an outlet on a 15-amp circuit breaker. Using an outlet on a 10-amp breaker will cause the breaker to trip. It is also important that the unit be the only appliance plugged into an outlet when in use. To avoid tripping a breaker, make sure the unit is the only appliance plugged into an outlet on a 15-amp breaker.

ACCESSORIES FOR PURCHASE

We offer a suite of custom-made accessories for your Ninja Sizzle™ Grill and Griddle. Visit ninjaaccessories.com to expand your capabilities and take your cooking to the next level.

REPLACEMENT PARTS

To order additional parts and accessories, visit ninjaaccessories.com or contact Customer Service at **1-877-646-5288**. So we may better assist you, please register your product online at registeryourninja.com and have the product on hand when you call.



ONE (1) YEAR LIMITED WARRANTY

NJA_1_YR_IB_LMTD_WRNTY_US_ENG

The One (1) Year Limited Warranty applies to purchases made from authorized retailers of **SharkNinja Operating LLC**. Warranty coverage applies to the original owner and to the original product only and is not transferable.

SharkNinja warrants that the unit shall be free from defects in material and workmanship for a period of one (1) year from the date of purchase when it is used under normal household conditions and maintained according to the requirements outlined in the Owner's Guide, subject to the following conditions and exclusions:

What is covered by this warranty?

1. The original unit and/or non-wearable parts deemed defective, in SharkNinja's sole discretion, will be repaired or replaced up to one (1) year from the original purchase date.
2. In the event a replacement unit is issued, the warranty coverage ends six (6) months following the receipt date of the replacement unit or the remainder of the existing warranty, whichever is later. SharkNinja reserves the right to replace the unit with one of equal or greater value.

What is not covered by this warranty?

1. Normal wear and tear of wearable parts (such as blending vessels, lids, cups, blades, blender bases, removable pots, racks, pans, etc.), which require regular maintenance and/or replacement to ensure the proper functioning of your unit, are not covered by this warranty. Replacement parts are available for purchase at ninjaaccessories.com.
2. Any unit that has been tampered with or used for commercial purposes.
3. Damage caused by misuse, abuse, negligent handling, failure to perform required maintenance (e.g., failure to keep the well of the motor base clear of food spills and other debris), or damage due to mishandling in transit.
4. Consequential and incidental damages.
5. Defects caused by repair persons not authorized by SharkNinja. These defects include damages caused in the process of shipping, altering, or repairing the SharkNinja product (or any of its parts) when the repair is performed by a repair person not authorized by SharkNinja.
6. Products purchased, used, or operated outside North America.

How to get service

If your appliance fails to operate properly while in use under normal household conditions within the warranty period, visit ninjakitchen.com/support for product care and maintenance self-help. Our Customer Service Specialists are also available at **1-877-646-5288** to assist with product support and warranty service options, including the possibility of upgrading to our VIP warranty service options for select product categories. So we may better assist you, please register your product online at registeryourninja.com and have the product on hand when you call.

SharkNinja will cover the cost for the customer to send in the unit to us for repair or replacement. A fee of \$20.95 (subject to change) will be charged when SharkNinja ships the repaired or replacement unit.

How to initiate a warranty claim

You must call **1-877-646-5288** to initiate a warranty claim. You will need the receipt as proof of purchase. We also ask that you register your product online at registeryourninja.com and have the product on hand when you call, so we may better assist you. A Customer Service Specialist will provide you with return and packing instruction information.

How state law applies

This warranty gives you specific legal rights, and you also may have other rights that vary from state to state. Some states do not permit the exclusion or limitation of incidental or consequential damages, so the above may not apply to you.

