

THANK YOU

for purchasing the Ninja® Double Oven



REGISTER YOUR PURCHASE



registeryourninja.com



Scan QR code using mobile device

TECHNICAL SPECIFICATIONS

Voltage: 120V-, 60Hz

Power: 1800 Watts

RECORD THIS INFORMATION

Model Number: _____

Serial Number: _____

Date of Purchase: _____

(Keep receipt)

Store of Purchase: _____

SharkNinja Operating LLC
US: Needham, MA 02494
1-877-646-5288
ninjakitchen.com

Illustrations may differ from actual product. We are constantly striving to improve our products, therefore the specifications contained herein are subject to change without notice.

NINJA is a registered trademark of SharkNinja Operating LLC.

The product may be covered by one or more U.S. patents.
See sharkninja.com/patents for more information.

© 2023 SharkNinja Operating LLC

DCT401CO_IB_MP_Mv6_LR



@ninjakitchen

NINJA

DOUBLE OVEN





DCT401CO Series | Owner's Guide



SCAN TO GET TO
KNOW YOUR OVEN
EXPLORE RECIPES AND MORE.

IMPORTANT SAFETY INSTRUCTIONS

PLEASE READ ALL INSTRUCTIONS CAREFULLY BEFORE USE • FOR HOUSEHOLD USE ONLY

	Read and review instructions to understand operation and use of product.
	Indicates the presence of a hazard that can cause personal injury, death or substantial property damage if the warning included with this symbol is ignored.
	Avoid contact with hot surface. Always use hand protection to avoid burns.
	For indoor and household use only.

WARNING

To reduce the risk of injury, fire, electrical shock or property damage, basic safety precautions must always be followed, including the following numbered warnings and subsequent instructions. Do not use appliance for other than intended use.

- 1 To eliminate a choking hazard for young children, discard all packaging materials immediately upon unpacking.
- 2 Take inventory of all contents to ensure you have all parts needed to properly and safely operate your oven.
- 3 This appliance can be used by persons with reduced physical, sensory or mental capabilities or lack of experience and knowledge if they have been given supervision or instruction concerning use of the appliance in a safe way and understand the hazards involved.
- 4 To eliminate a choking hazard for young children, discard all packaging materials immediately upon unpacking.
- 5 **DO NOT** use an extension cord. A short power-supply cord is used to reduce the risk of children grabbing the cord or becoming entangled and to reduce the risk of people tripping over a longer cord.
- 6 **NEVER** use outlet below counter level.
- 7 Keep the appliance and its cord out of reach of children. **DO NOT** allow the appliance to be used by children. Close supervision is necessary when used near children.
- 8 **DO NOT** let cord hang over edges of tables or counters or touch hot surfaces, including stoves and other heating ovens.
- 9 **NEVER** leave the oven unattended while in use.
- 10 If food contents were to catch fire during cooking, **DO NOT** open the oven door.
 - If you can safely do so, unplug the oven immediately.
 - **DO NOT** throw water onto the fire. Food contents may contain grease and water may cause fire growth.
 - If fire were to emit from the oven door, call the fire department immediately.
 - **DO NOT** use the oven after it has experienced a fire, it may have been damaged and present a risk of fire or shock.
- 11 **DO NOT** place any object directly onto the heating elements. **DO NOT** cover the crumb tray, heating elements, or walls of oven. This will cause the oven to overheat or cause a fire.
- 12 **DO NOT** use the oven with crumb tray incorrectly installed. Crumb tray **MUST** be placed below lower heating elements.
- 13 To protect against electrical shock **DO NOT** immerse cord, plugs, or main unit housing in water or other liquid.
- 14 **DO NOT** place appliance on hot surfaces, near a hot gas or electric burner, in a heated oven, or on a stovetop.
- 15 **DO NOT** use the oven with damage to the power cord or plug. Regularly inspect the oven and power cord. If the oven malfunctions or has been damaged in any way, immediately stop use and call Customer Service.
- 16 **DO NOT** cover the air intake vents or air outlet vents while unit is operating. Doing so will prevent even cooking and may damage the unit or cause it to overheat.

IMPORTANT SAFETY INSTRUCTIONS

PLEASE READ ALL INSTRUCTIONS CAREFULLY BEFORE USE • FOR HOUSEHOLD USE ONLY

- 17 DO NOT** insert anything in the ventilation slots and do not obstruct them.
- 18 DO NOT** place items on top of surface while unit is operating except for authorized recommended Ninja® accessories.
- 19** Before placing any accessories into the oven ensure they are clean and dry.
- 20** Intended for countertop use only. **DO NOT** place the oven near the edge of the countertop. Ensure the surface is level, clean and dry.
- 21** This oven is for household use only. **DO NOT** use this oven for anything other than its intended use. Misuse may cause injury.
- 22 DO NOT** store any materials, other than supplied accessories, in this oven when not in use.
- 23 DO NOT** use outdoors. **DO NOT** use in moving vehicles or boats.
- 24 DO NOT** use accessory and attachments not recommended or sold by SharkNinja.
- 25** When using this oven, provide adequate space (at least 1 inch above and on all sides) for air circulation.
- 26** A fire may occur if the oven is covered or touching flammable material, including curtains, draperies, walls, or the like when in operation.
- 27** This oven has a tempered glass door and is more resistant to breakage. Avoid scratching door surface or nicking edges.
- 28 DO NOT** place anything directly on heating elements and **DO NOT** use the oven without a wire rack or air fry basket installed.
- 29 DO NOT** spray any type of aerosol spray or flavoring inside the oven while cooking.
- 30** Use caution when inserting and removing anything from the oven, especially when hot.
- 31** Outlet voltages can vary, affecting the performance of your product. To prevent possible illness, use a thermometer to check that your food is cooked to the temperatures recommended.
- 32** Prevent food contact with heating elements. Excessive food loads may cause personal injury or property damage or affect the safe use of the oven.
- 33** Oversize foods or metal utensils must not be inserted in a toaster oven as they may create a fire or risk of electric shock.
- 34** With the exception of parchment paper, **DO NOT** place any of the following materials in the oven: paper, cardboard, plastic, roasting bags and the like.
- 35 EXTREME CAUTION** should be exercised when using containers constructed of any materials other than metal or glass.
- 36 DO NOT** touch hot surfaces. Oven surfaces and glass door are hot during and after operation. To prevent burns or personal injury, **ALWAYS** use protective hot pads or insulated oven mitts and use available handles.
- 37** Spilled food can cause serious burns. Extreme caution must be used when the oven contains hot food. Improper use may result in personal injury.
- 38** Please refer to the Cleaning & Maintenance section for regular maintenance of the oven.
- 39** Cleaning and user maintenance shall not be done by children.
- 40** Allow to cool completely before cleaning and moving for storage.
- 41** When not in use, press the Power Button to OFF[®], then unplug. Grasp the plug by the body and pull from the outlet. Never unplug by grasping and pulling flexible cord.
- 42 DO NOT** clean with metal scouring pads. Pieces can break off the pad and touch electrical parts, causing a risk of electrical shock.
- 43 DO NOT** use the oven as a source of heat or for drying.
- 44** This appliance has important markings on the plug blade. The entire supply cord is not suitable for replacement. If damaged, please contact SharkNinja for service.

SAVE THESE INSTRUCTIONS

PARTS & ACCESSORIES

- A Main Unit**
(attached power cord not shown)
- B Air Fry Basket**
Install when using the air fry function.
Hand-wash recommended.
- C Sheet Pan(s)**
Place on top of the wire rack.
Hand-wash only.
- D 2 Wire Racks**
Use on its own or place the sheet pan on top.
Hand-wash recommended.
- E 1 Removable Crumb Tray**
(already installed in unit)
Must remain installed when the top oven is in use. Also able to use in the bottom oven. Hand-wash only.
- F Roast Tray**
Place on top of the the sheet pan on wire rack. Hand-wash only.
- G Ninja NeverStick™ Premium 9" Round Cake Pan**
Place on wire rack or on top of sheet pan on wire rack for proofing. Dishwasher safe.
- H Ninja NeverStick™ Premium 8" Square Cake Pan**
Place on top of wire rack. Dishwasher safe.

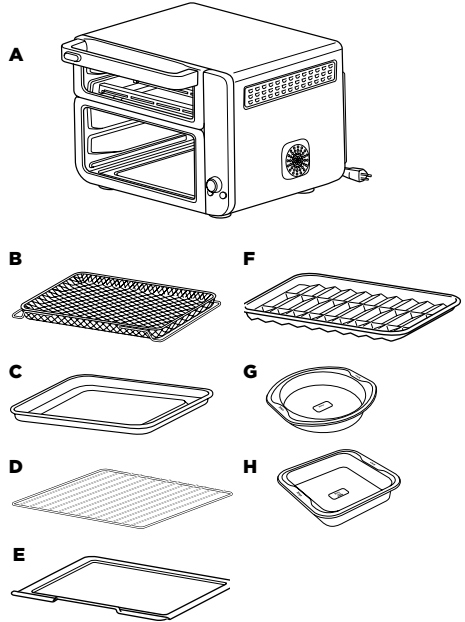

IMPORTANT: Unit includes 1 removable crumb tray. Place crumb tray below lower heating elements in the Top Oven or at the very bottom of the Bottom Oven. **DO NOT** slide into any rack positions.

COMMON-SENSE PRACTICES/GOOD HABITS:

- **DO NOT** leave your toaster oven unattended while making food. If possible, unplug the oven while not in use to eliminate the possibility of accidents occurring.
- Have a fire extinguisher or fire containment blanket handy in a safe, known location. If you don't have a fire extinguisher, douse the flames with baking soda until they are put out.
- If a fire occurs and the food in the oven is not greasy, immediately unplug the unit and douse the flames with water until the fire is extinguished. **DO NOT** use water if grease is present, since it could make the fire worse. Use baking soda instead.

BEFORE FIRST USE

- 1 Remove and discard any packaging material, promotional labels, and tape from the unit.
- 2 Remove all accessories from the package and read this manual carefully. Please pay particular attention to operational instructions, warnings, and important safeguards to avoid any injury or property damage.
- 3 Wash the air fry basket, sheet pans, wire rack, roast tray, cake pans, and removable crumb tray in warm, soapy water, then rinse and dry thoroughly. **DO NOT** put sheet pan or removable crumb tray in the dishwasher. Finishes may degrade. **NEVER** submerge the main unit in water.

We recommend placing all accessories inside the oven and running the top oven on Bake at 450°F for 25 minutes, with the bottom oven on Air Fry at 450°F for 25 minutes without adding any food. Make sure the area is well ventilated, as some odor may be released. This removes any packaging residue and odor traces that may be present. This is completely safe and not detrimental to the performance of the oven.

NOTE: The accessories are hand-wash recommended. The air fry basket and wire racks can be put in the dishwasher, but may wear more quickly over time. The cake pans are dishwasher safe.

USING THE CONTROL PANEL

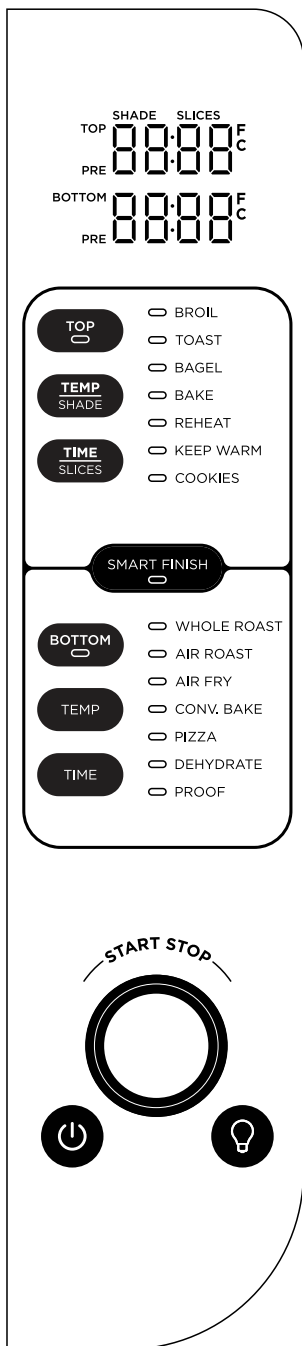

FUNCTIONS

Once you've selected a function below, you can change temperature/shade and time/slices.

NOTE: The Dehydrate, Reheat, Keep Warm, Cookies, and Proof functions are not included on all models.

TOP OVEN:

BROIL: Evenly broil meats or fish and brown the tops of casseroles.

TOAST: Toast up to 6 slices of bread to your desired level of darkness.

BAGEL: Perfectly toast up to 6 bagel halves when they're placed cut-side up on the wire rack.

BAKE: Evenly bake everything from your favorite cookies to cakes.

REHEAT: Heat leftovers without over cooking.

KEEP WARM: Keep food warm after cooking.

COOKIES: Refined to perfectly bake a fresh batch of brownies.

BOTTOM OVEN:

WHOLE ROAST: Simultaneously roast large proteins (like a 4½-lb chicken) and sides for a complete meal.

AIR ROAST: Achieve a crispy outside and perfectly cooked inside for full-sized sheet pan meals, thicker proteins, and roasted veggies.

AIR FRY: Foods that would traditionally be fried—such as chicken wings, French fries, and chicken nuggets—with little to no added oil.

CONVECTION BAKE (CONV. BAKE):

Evenly bakes cookies, cakes, brownies, and other goods faster.

PIZZA: Cook frozen or homemade pizzas evenly.

DEHYDRATE: Dehydrate meats, fruits, and vegetables for healthy snacks.

PROOF: Creates a warm environment for dough to rest and rise.

NOTE: The oven's technology leads to faster cooking. Always monitor food to prevent overcooking. Refer to cook charts in the Inspiration Guide for more guidance on cook times and temperatures.



**SCAN TO GET TO
KNOW YOUR OVEN**
EXPLORE RECIPES AND MORE.

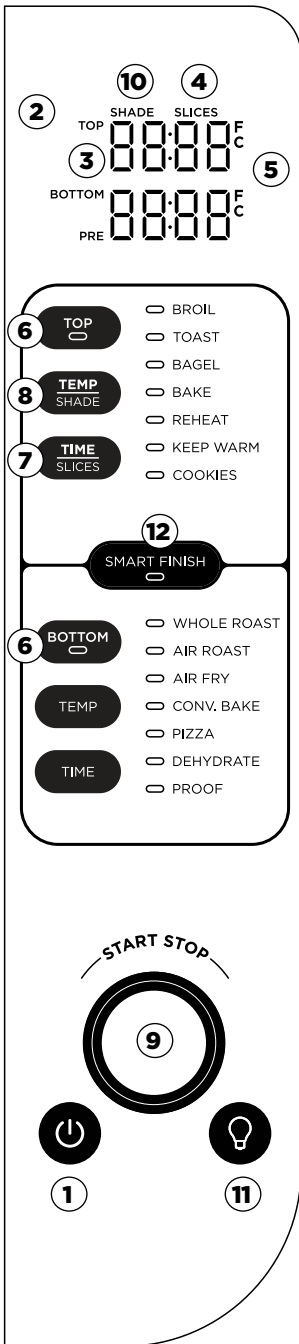

CONTROL PANEL DISPLAY & OPERATING BUTTONS

- 1 (Power) button:** Press to turn the unit on and off.
- 2 Time display:** Shows the cook time. The time will count down when cooking is in progress.
- 3 PREHEAT:** PRE will display on the clock while the oven is preheating. If the oven is already up to temperature from using a previous cooking function, the unit will skip preheating, and the cook timer will start.
- 4 SLICES:** Illuminates when using the Toast or Bagel function to designate number of slices.
- 5 Temperature display:** Shows the cook temperature.

NOTE: Time and temperature will always return to the settings used the last time the oven was in operation.

- 6 TOP and BOTTOM buttons:** To select a cooking function, press the TOP button and turn dial to select Top Oven functions (Broil, Toast, Bagel, Pizza, Reheat, Keep Warm, or Cookies) or the BOTTOM button and turn dial to select Bottom Oven functions (Whole Roast, Air Roast, Air Fry, Convection Bake, Pizza, Dehydrate, and Proof). Press and hold TOP or BOTTOM button for 3 seconds to turn off that oven.
- 7 TIME/SLICES button:** To select a cook time, press the TIME/SLICES button (Top Oven) or the TIME button (Bottom Oven), then rotate dial to increase or decrease time in 1-minute increments under 1 hour and 5-minute increments over 1 hour. When using the Toast or Bagel function, these buttons will adjust the number of slices/bagel halves instead of the time.
- 8 TEMP/SHADE button:** To adjust temperature, press the TEMP/SHADE button (Top Oven) or the TEMP button (Bottom Oven), then rotate dial to increase or decrease temperature in 5-degree increments. When using the Toast or Bagel function, the dial will adjust the shade level from 1 (lightest) to 7 (darkest) instead of the temperature.
- 9 START/STOP dial:** Push to start or stop cooking. When using both ovens, START/STOP will start or stop both ovens. To Stop or Start one oven, press TOP or BOTTOM then the START/STOP dial.
- 10 SHADE:** Illuminates when using the Toast or Bagel function to designate desired shade.
- 11 (Light) button:** Press to turn the oven's interior light on and off.
- 12 SMART FINISH button:** When cooking in both ovens, press before pressing START/STOP dial to have both ovens finish at the same time.

HOW TO REDUCE SMOKE

We recommend using canola, coconut, avocado, grapeseed, or vegetable oil instead of olive oil.



Recommended:

- Canola
- Refined coconut
- Avocado
- Vegetable
- Grapeseed



Not recommended:

- Olive oil
- Butter
- Margarine

The unit may produce smoke when cooking on a hotter setting than what is recommended.

NOTE: For more cooking charts, refer to your Inspiration Guide or visit ninjakitchen.com.

WHEN TO USE THE ROAST TRAY

Use Roast Tray on Sheet Pan when cooking on convection functions (such as Whole Roast, Air Roast, and Air Fry), or with greasy foods like: whole chicken, chicken wings, bacon, marinated meats, or oiled vegetables.

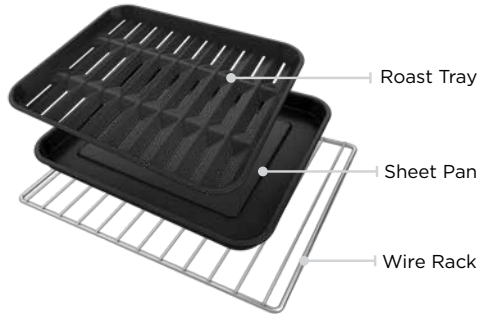

Recommended:



Whole Chicken



Chicken Wings
or Thighs



Bacon



Marinated Meats



Oiled Vegetables

USING YOUR DOUBLE OVEN

USING THE COOKING FUNCTIONS IN TWO OVENS

The oven has 1 available rack position in the top oven and 2 available rack positions in the bottom oven for sliding accessories into the unit.

Positioning the Racks

Each cook function corresponds to a specific oven and rack level. See the chart below to determine the recommended accessory and rack level for each cook function. For best results, use only the recommended accessories for each function and remove others from the oven.

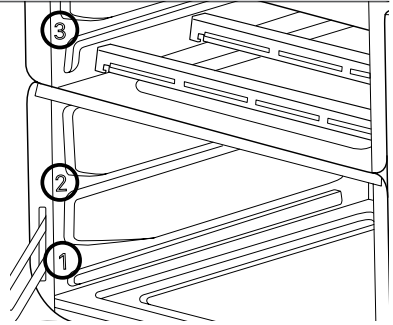

		BROIL	TOAST	BAGEL	BAKE/COOKIES	REHEAT/KEEP WARM
TOP OVEN	LEVEL 3	Sheet Pan on Wire Rack	Wire Rack	Wire Rack	Sheet Pan on Wire Rack	Sheet Pan on Wire Rack

NOTE: When cooking greasy, drippy foods, place the Sheet Pan on the Wire Rack below to catch the drippings.

		WHOLE ROAST	AIR ROAST	AIR FRY	BAKE/PIZZA	DEHYDRATE	PROOF
BOTTOM OVEN	LEVEL 2		Wire Rack	Air Fry Basket		Air Fry Basket	
	LEVEL 1	Sheet Pan on Wire Rack	Sheet Pan on Wire Rack	Add sheet pan on wire rack for greasy, drippy foods	Sheet Pan on Wire Rack		Cake Pan on Sheet Pan on Wire Rack

NOTE: Always place Sheet Pan on Wire Rack. **DO NOT** place directly on heating elements.

NOTE: When using PROOF, add two tablespoons of water to the sheet pan.

USING YOUR DOUBLE OVEN - CONT.

To turn on the unit, plug the power cord into an outlet and press the button. The unit will automatically shut off after 10 minutes of inactivity.

USING TWO OVENS

NOTE: PREHEAT FOR BEST RESULTS. Add food only when preheating is complete (up to 3 minutes after pressing START/STOP). Broil, Toast, Bagel, Keep Warm, Dehydrate, and Proof do not have a preheat. If Smart Finish is enabled, preheat will only occur in the oven with the longest cook time.

- 1 Press the POWER button to turn the oven on or off.
- 2 Press TOP and turn dial to select top functions. Press TOP again to confirm function selection.
- 3 Press the TEMP/SHADE button and then turn the dial to set the cook temperature for the top oven function (shade darkness will be adjusted for Toast and Bagel). Press again to confirm the setting.
- 4 Press the TIME/SLICES button and turn the dial to set the cook time for top oven function (number of slices will be adjusted for Toast and Bagel). Press again to confirm the setting.
- 5 Press BOTTOM and turn dial to select bottom oven functions. Press again to confirm the setting.
- 6 Press the TEMP button and then turn the dial to set the cook temperature for the bottom oven function. Press again to confirm the setting.
- 7 Press the TIME button and then turn the dial to set the cook time for the bottom oven function. Press again to confirm the setting.
- 8 Press the START/STOP dial to start cooking in both ovens. Preheating is required for Bake, Cookies, Whole Roast, Air Roast, Air Fry, Convection Bake, and Pizza.

USING TWO OVENS WITH SMART FINISH

NOTE: PREHEAT FOR BEST RESULTS. Add food only when preheating is complete (up to 3 minutes after pressing START/STOP). Broil, Toast, Bagel, Keep Warm, Dehydrate, and Proof do not have a preheat. If Smart Finish is enabled, preheat will only occur in the oven with the longest cook time.

- 1 Press the POWER button to turn the oven on or off.
- 2 Press TOP and turn dial to select top functions. Press TOP again to confirm function selection.
- 3 Press the TEMP/SHADE button and then turn the dial to set the cook temperature for the top oven function (shade darkness will be adjusted for Toast and Bagel). Press again to confirm the setting.
- 4 Press the TIME/SLICES button and turn the dial to set the cook time for the top oven function (number of slices will be adjusted for Toast and Bagel). Press again to confirm the setting.
- 5 Press BOTTOM and turn dial to select bottom oven functions. Press again to confirm the setting.
- 6 Press the TEMP button and then turn the dial to set the cook temperature for the bottom oven function. Press again to confirm the setting.
- 7 Press the TIME button and then turn the dial to set the cook time for the bottom oven function. Press again to confirm the setting.
- 8 To use different settings in both ovens and have them finish at the same time, press the SMART FINISH™ button. Set after setting function, temperature for one oven then setting other, or set after setting function, temperature, and time for both ovens..
- 9 Press the START/STOP dial to start cooking in both ovens. Preheating is required for Bake, Whole Roast, Air Roast, Air Fry, Convection Bake, and Pizza.
- 10 When the unit beeps to signify it has preheated, immediately place food in unit and close the door.
- 11 During the initial set up, the oven with the shorter cook time will display HOLD until time matches the other oven.

To turn on the unit, plug the power cord into an outlet and press the button. The unit will automatically shut off after 10 minutes of inactivity.

TOP OVEN FUNCTIONS

Broil

NOTE: The unit does not preheat in Broil mode.

- 1 To select the function, press the TOP button and rotate dial until BROIL illuminates. The default time and temperature settings will display. Press the TOP button again to confirm broil selection.
- 2 Press the TIME/SLICES button and rotate dial to select a cook time up to 30 minutes. Press the TIME/SLICES button again to confirm selection.
- 3 Press the TEMP/SHADE button and rotate dial to select HI or LO. Press the TEMP/SHADE button again to confirm temperature selection.
- 4 Place ingredients on the sheet pan. Place the sheet pan on the wire rack on Level 3 in the Top Oven and close the oven door, press START/STOP dial to start cooking.
- 5 When cook time is complete, the unit will beep and END will appear on the display.

Toast

NOTE: The unit does not preheat in Toast mode.

- 1 To select the function, press the TOP button and rotate dial until TOAST illuminates. The default amount of slices and darkness level will display. Press the TOP button again to confirm selection.
- 2 Press the TIME/SLICES button and rotate dial to select the number of bread slices. You may toast up to 6 slices at once. Press the TIME/SLICES button again to confirm selection.
- 3 Press the TEMP/SHADE button and rotate dial to select a darkness level. Press the TEMP/SHADE button again to confirm selection.

NOTE: There is no temperature adjustment available for the Toast function, and the unit does not preheat in Toast mode. It is very important to select the exact number of slices to avoid over- or under-toasting.

- 4 Place bread slices on the wire rack in the Top Oven. Close oven door and press START/STOP dial to begin cooking.
- 5 When cook time is complete, the unit will beep and END will appear on the display.

NOTE: You can also manually adjust the time once cooking has started to better choose your preferred shade.

Bagel

NOTE: The unit does not preheat in Bagel mode.

- 1 To select the function, press the TOP button and rotate dial until BAGEL illuminates. The default number of slices and darkness level will display. Press the TOP button again to confirm function selection.
- 2 Press the TIME/SLICES button and rotate dial to select the number of slices. You may toast up to 6 bagel slices at once. Press the TIME/SLICES button again to confirm time selection.
- 3 Press the TEMP/SHADE button and rotate dial to select a darkness level. Press the TEMP/SHADE button again to confirm temperature selection.

NOTE: There is no temperature adjustment available for the Bagel function, and the unit does not preheat in Toast mode. It is very important to select the exact number of slices to avoid over- or under-toasting.

- 4 Place bagel slices, cut-side up, in the middle of the wire rack in the Top Oven. Close oven door and press START/STOP dial to begin cooking.
- 5 When cook time is complete, the unit will beep and END will appear on the display.

NOTE: You can also manually adjust the time once cooking has started to better choose your preferred shade.

Bake

- 1 To select the function, press the TOP button and rotate dial until BAKE illuminates. The default time and temperature settings will display.
- 2 Press the TIME/SLICES button and rotate dial to select a cook time up to 4 hours.

NOTE: If cooking for 1 hour or less, the clock will count down by minutes and seconds. If cooking for more than 1 hour, the clock will count down by hours and minutes.

- 3 Press the TEMP/SHADE button and rotate dial to select a temperature between 180°F and 450°F. Press the TEMP/SHADE button again to confirm temperature selection.
- 4 Press START/STOP dial to begin preheating.
- 5 Place ingredients on the sheet pan, cake pan, or casserole dish. When the unit beeps to signify it has preheated, immediately place the sheet pan on the wire rack on Level 1 in the Bottom Oven. Close oven door.

USING YOUR DOUBLE OVEN - CONT.

To turn on the unit, plug the power cord into an outlet and press the button. The unit will automatically shut off after 10 minutes of inactivity.

NOTE: The timer will start counting down as soon as the unit has preheated. If ingredients are not ready to go into the oven, simply press the TIME button and rotate dial to add more time.

- 6 During cooking, you can turn on the light  to check on progress.
- 7 When cook time is complete, the unit will beep and END will appear on the display.

Reheat

NOTE: The Reheat function is not included on all models.

NOTE: The unit does not preheat in Reheat mode.

- 1 To select the function, press the TOP button and rotate dial until REHEAT illuminates. Press the TOP button again to confirm function selection.
- 2 Press the TIME/SLICES button and rotate dial to select a reheat time up to 4 hours. Press the TIME/SLICES button again to confirm time selection.
- 3 Press the TEMP/SHADE button and rotate dial to select a temperature between 100°F and 450°F. Press the TEMP/SHADE button again to confirm temperature selection.
- 4 Place food on the sheet pan or in an oven-safe container and place the pan or container on the wire rack in the Top Oven. Close oven door and press START/STOP dial to begin warming.
- 5 When cook time is complete, the unit will beep and END will appear on the display.

Keep Warm

NOTE: The Keep Warm function is not included on all models.

- 1 To select the function, press the TOP button and rotate dial until KEEP WARM illuminates. The default time and temperatures settings will display. Press the TOP button again to confirm function selection.
- 2 Press the TIME/SLICE button and turn the dial to select a time up to 2 hours. Press the TIME/SLICES button again to confirm time selection.

NOTE: There is no temperature selection available for the Keep Warm function.

- 3 Place food on the sheet pan or in an oven-safe container and place the pan or container on the wire rack on level level 3 in the top oven. Close oven door and press START/STOP dial to begin warming.

- 4 When warming time is complete, the unit will beep and "END will appear on the display.

NOTE: There is no temperature adjustment available for the the Toast function, and the unit does not preheat in Keep Warm mode. It is very important to select the exact number of slices to avoid over- or under-toasting.

Cookies

NOTE: The Cookies function is not included on all models.

- 1 To select the function, press the TOP button and rotate dial until COOKIES illuminates. The default time and temperature settings will display.
- 2 Press the TIME/SLICES button and rotate dial to select a cook time up to 4 hours.

NOTE: If cooking for 1 hour or less, the clock will count down by minutes and seconds. If cooking for more than 1 hour, the clock will count down by hours and minutes.

- 3 Press the TEMP/SHADE button and rotate dial to select a temperature between 180°F and 450°F. Press the TEMP/SHADE button again to confirm temperature selection.
- 4 Press START/STOP dial to begin preheating.
- 5 Place ingredients on the sheet pan. When the unit beeps to signify it has preheated, immediately place the sheet pan on the wire rack in the Top Oven. Close oven door.

NOTE: The timer will start counting down as soon as the unit has preheated. If ingredients are not ready to go into the oven, simply press the TIME button and rotate dial to add more time.

- 6 During cooking, you can turn on the light to check on progress.
- 7 When cook time is complete, the unit will beep and END will appear on the display.

NOTE: For best results, line the Ninja® Sheet Pan with parchment paper.

To turn on the unit, plug the power cord into an outlet and press the button. The unit will automatically shut off after 10 minutes of inactivity.

BOTTOM OVEN FUNCTIONS

NOTE: When using only Bottom Oven with high moisture foods (like frozen foods), it is normal to see condensation in the Top Oven window.

Whole Roast

- 1 To select the function, press the BOTTOM button and rotate dial until WHOLE ROAST illuminates. The default time and temperature settings will display. Press the BOTTOM button again to confirm function selection.
- 2 Press the TIME button then rotate dial to select a cook time up to 4 hours. Press the TIME button again to confirm time selection.

NOTE: If cooking for 1 hour or less, the clock will count down by minutes and seconds. If cooking for more than 1 hour, the clock will count down by hours and minutes.

- 3 Press the TEMP button and rotate dial to select a temperature between 250°F and 450°F. Press the TEMP button again to confirm temperature selection.
- 4 Press START/STOP dial to begin preheating.

NOTE: Food cooks faster when using the Whole Roast function so refer to cook charts in the Inspiration Guide for more guidance on cook times and temperatures.

- 5 Place ingredients directly on sheet pan. When the unit beeps to signify it has preheated, immediately place sheet pan on the wire rack on Level 1 in the Bottom Oven. Close oven door.
- 6 When cook time is complete, the unit will beep and END will appear on the display.

NOTE: The timer will start counting down as soon as the unit has preheated. If ingredients are not ready to go into the oven, simply press the TIME button and rotate the dial to add more time.

Air Roast

- 1 To select the function, press the BOTTOM button and rotate dial until AIR ROAST illuminates. The default time and temperature settings will display. When cooking 2 layers, select the 2 LEVEL button so that 2 LEVEL appears on the display.
- 2 Press the TIME/SLICES buttons to select a cook time up to 4 hours.

- 3 Press the TEMP button and rotate dial to select a temperature between 250°F and 450°F. Press the TEMP button again to confirm temperature selection.
- 4 Press START/STOP dial to begin preheating.

NOTE: If cooking for 1 hour or less, the clock will count down by minutes and seconds. If cooking for more than 1 hour, the clock will count down by hours and minutes.

- 5 Place ingredients on the sheet pan. When the unit beeps to signify it has preheated, immediately place the sheet pan on the wire rack on Level 1 in the Bottom Oven. Close oven door.

NOTE: Food cooks faster when using the Air Roast function, so refer to cook charts in the Inspiration Guide for more guidance on cook times and temperatures.

- 6 When cook time is complete, the unit will beep and "END" will appear on the display.

Air Fry

- 1 To select the function, press the BOTTOM button and rotate dial until AIR FRY illuminates. The default time and temperature settings will display. When cooking 2 layers, select the 2 LEVEL button so that 2 LEVEL appears on the display.
- 2 Press the TIME/SLICES buttons to select a cook time up to 4 hours. Press the TIME button again to confirm time selection.
- 3 Then press the TEMP button and rotate dial to select a temperature between 250°F and 450°F. Press the TEMP button again to confirm temperature selection.
- 4 Press START/STOP dial to begin preheating.

NOTE: The timer will start counting down as soon as the unit has preheated. If ingredients are not ready to go into the oven, simply press TIME button and rotate dial to add more time.

- 5 Place ingredients in the air fry basket on Level 2 in the Bottom Oven. If ingredients are fatty, oily, or marinated, place the sheet pan on wire rack on Level 1 in the Bottom Oven. Use air fry basket for dry ingredients.
- 6 When the unit beeps to signify it has preheated, immediately slide the basket into Level 1 in the Bottom Oven. If also using the sheet pan, slide both into the oven at the same time, with the basket in the upper rack and the pan on the wire rack beneath the basket. Close oven door.
- 7 When cook time is complete, the unit will beep and END will appear on the display.

USING YOUR DOUBLE OVEN - CONT.

To turn on the unit, plug the power cord into an outlet and press the button. The unit will automatically shut off after 10 minutes of inactivity.

NOTE: Food cooks faster when using the Air Fry function. Refer to Air Fry Chart in the Inspiration Guide for more guidance on cook times and temperatures.

Convection Bake

- 1 To select the function, press the BOTTOM button and rotate dial until CONVECTION BAKE illuminates. The default time and temperature settings will display. Press the BOTTOM button again to confirm function selection.
- 2 Press the TIME button and turn the dial to select a cook time up to 4 hours. Press the TIME button again to confirm time selection.

NOTE: The timer will start counting down as soon as the unit has preheated. If ingredients are not ready to go into the oven, simply press the TIME button and rotate dial to add more time.

- 3 Press the TEMP button and turn the dial to select a temperature between 180°F and 450°F. Press the TEMP button again to confirm temperature selection.
- 4 Press START/STOP to begin preheating.
- 5 Place ingredients on the sheet pan, cake pan, or casserole dish. When the unit beeps to signify it has preheated, immediately place the sheet pan on the wire rack on bottom level in the Bottom Oven. Close oven door.

NOTE: The timer will start counting down as soon as the unit has preheated. If ingredients are not ready to go into the oven, simply press the TIME button to add more time.

- 6 During cooking, you can turn on the light to check on progress.
- 7 When cook time is complete, the unit will beep and END will appear on the display.

Pizza

- 1 To select the function, press the BOTTOM button and rotate dial until PIZZA illuminates. The default time and temperature setting will display. Press the BOTTOM button again to confirm function selection.
- 2 Press the TIME button and rotate dial to select a cook time up to 4 hours. Press the TIME button again to confirm time selection.
- 3 Press the TEMP button and rotate dial to select a temperature between 180°F and 450°F. Press the TEMP button again to confirm temperature selection.
- 4 Place pizza on the sheet pan or directly on the wire rack on Level 2 in the Bottom Oven. Close oven door and press START/STOP dial to begin cooking.
- 5 When cook time is complete, the unit will beep and END will appear on the display.

NOTE: If cooking for 1 hour or less, the clock will count down by minutes and seconds. If cooking for more than 1 hour, the clock will count down by hours and minutes.

Dehydrate

NOTE: Purchase additional dehydrate accessory to dehydrate up to 2 levels at one time.

NOTE: Unit does not preheat in Dehydrate mode.

- 1 To select the function, press the BOTTOM button and rotate dial until DEHYDRATE illuminates. The default time and temperature settings will display. Press the BOTTOM button again to confirm function selection.
- 2 Press the TIME button and rotate dial to select a dehydrate time up to 24 hours. Press the TIME button again to confirm time selection.
- 3 Press TEMP button and rotate dial to select a temperature between 85°F and 200°F. Press TEMP button again to confirm temperature selection.
- 4 Place ingredients in the air fry basket on Level 2 in the Bottom Oven. Close oven door and press START/STOP dial to begin cooking.

NOTE: For best results, lay ingredients flat on each layer; do not stack food.

- 5 When cook time is complete, the unit will beep and END will appear on the display.

Proof

- 1 To select the function, press the BOTTOM button and rotate dial until PROOF illuminates. The default time and temperature settings will display. Press the BOTTOM button again to confirm function selection.
- 2 Press the TIME button and rotate dial to select a PROOF time up to 4 hours. Press the TIME button again to confirm time selection.
- 3 Press TEMP button and rotate dial to select a temperature between 70°F and 120°F. Press TEMP button again to confirm temperature selection.
- 4 Slide wire rack into Level 1 in the Bottom Oven. Place dough in the cake pan, then place on top of sheet pan. Add two tablespoons of water to the sheet pan and slide onto the wire rack in the Bottom Oven. Close oven door and press START/STOP dial to begin cooking.

NOTE: Keep an eye on dough while proofing for desired result.

- 5 When cook time is complete, the unit will beep and END will appear on the display.

CLEANING & MAINTENANCE

EVERYDAY CLEANING

The unit should be cleaned thoroughly after every use.

- 1 Unplug the unit from the outlet and allow it to cool down before cleaning.
- 2 Empty crumb tray by sliding it out of the oven. The crumb tray can fit in both the Top and Bottom ovens.

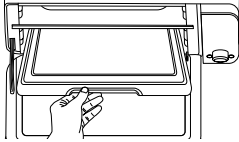

NOTE: Empty crumb tray frequently. Hand-wash when necessary.

- 3 After every use, wipe away any food splatter on the interior walls and glass door of the unit with a soft, damp sponge.
- 4 To clean the exterior of the main unit and the control panel, wipe them clean with a damp cloth. A non-abrasive liquid cleanser or mild spray solution may be used. Apply the cleanser to the sponge, not the oven surface, before cleaning.
- 5 When using accessories, we recommend greasing them with recommended cooking oil, or covering them with parchment paper or aluminum foil before placing food on top.

NOTE: When using parchment paper or aluminum foil, cut to size of accessory. The parchment paper or aluminum foil should not touch any of the heating elements or the inside oven walls as it could cause smoke. **DO NOT** use parchment paper on Broil or above the recommended manufacturer's instructions.

DEEP CLEANING

- 1 Unplug the unit from the outlet and allow it to cool down before cleaning.
 - 2 Remove all accessories from the unit, including the crumb tray, and wash separately. Use a non-abrasive cleaning brush to more thoroughly wash the air fry basket. Accessories are hand-wash recommended. The air fry basket and wire racks can be put in the dishwasher, but may wear more quickly over time. **DO NOT** place sheet pan, roast tray, or crumb tray in the dishwasher.
 - 3 Use warm, soapy water and a soft cloth to wash the oven's interior and glass door, **DO NOT** use abrasive cleaners, scrubbing brushes, or chemical cleaners, as they will damage the oven.
- CAUTION: NEVER** put the main unit in the dishwasher or immerse it in water or any other liquid.
- 4 To remove tough grease, let sheet pan soak overnight in warm, soapy water, then wash with a non-abrasive sponge or brush.
 - 5 Thoroughly dry all parts before placing them back in the oven.

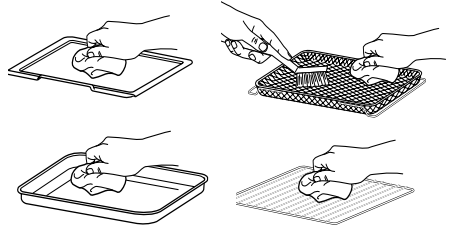

IMPORTANT: Place crumb tray below lower heating elements in the top oven. **DO NOT** slide into any rack positions.

ACCESSORIES FOR PURCHASE

We offer a suite of accessories custom made for your Ninja® Double Oven. Visit ninjaaccessories.com to expand your capabilities and take your cooking to the next level.

- Cutting Board

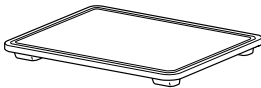

- Nonstick Air Fry Basket



REPLACEMENT PARTS

To order additional parts and accessories, visit ninjaaccessories.com or contact Customer Service at **1-877-646-5288**. We ask that you register your product online at registryourninja.com and have the product on hand when you call, so we may better assist you.

TROUBLESHOOTING & FAQ

ERROR MESSAGES

“Er0,” “Er1,” “Er2,” “Er3,” “Er4,” “Er5,” or “Er6”

Turn off the unit and call Customer Service at **1-877-646-5288**. So we may better assist you, please register your product online at registeryourninja.com and have the product on hand when you call.

FAQ

Why won't the oven turn on?

- Make sure the power cord is securely plugged into the outlet.
- Insert the power cord into a different outlet.
- Press the power button.
- Contact licensed electrician if a faulty outlet is suspected.

Can I use the sheet pan instead of the air fry basket with the Air Fry function?

- Yes, but crispiness results may vary.

Do I need to adjust the cook times and temperatures of traditional oven recipes?

- For best results, keep an eye out on your food while cooking. Refer to cook charts in the Inspiration Guide for more guidance on cook times and temperatures.

Can I restore the unit to its default settings?

- The oven will remember the last setting used for each function, even if you unplug it. To restore the oven's default settings for each function, press the TEMP/SHADE and TIME/SLICES buttons and rotate the dial simultaneously for 5 seconds.

Why do the heating elements appear to be turning on and off?

- This is normal. The oven is designed to control temperature precisely for every function by adjusting the heating elements' power levels.

Why does the oven have a different temperature reading with an external thermometer?

- Convection ovens circulate air differently than traditional ovens, so when the door is opened, more heat will escape. This may affect any external temperature reading of the unit's interior temperature.
- Since this is a convection oven, it can cook more quickly than a traditional oven. Convection cooking includes a fan that helps speed up cook time by circulating hot air and can affect temperatures within the cavity. The time it takes the unit to heat up to the set temperature will vary based on the amount of food being cooked, the function being used, and the cook temperature and time. The oven features an algorithm that ensures temperature and time settings work with most traditional oven recipes. As a result, the temperature inside the oven may differ from the set temperature. This does not impact cooking quality. Refer to the Inspiration Guide to learn more about recommended cook times and temperatures.

Why is my unit not fully preheated when the preheat cycle is completed?

- During preheating, the unit will not reach the intended cook temperature, but it will preheat to a level that will start cooking your ingredients. As the cook cycle continues, the oven will continue to heat up and cook your food to doneness. It may take up to 10 minutes for the unit to reach the intended cook temperature. This does not affect the cooking quality of most recipes.

Why is steam coming out from the oven door?

- This is normal. Foods with a high moisture content may release steam around the door.

Why is water dripping onto the counter from under the door?

- This is normal. The condensation created by foods with a high moisture content (such as frozen foods) may run down the inside of the door and drip onto the counter.

Why is the unit generating smoke?

- It is highly recommended to clean all accessories and the inside of the oven after each use to prevent grease build up that can cause smoke.
- Ensure you are using the sheet pan when cooking all greasy foods, or when using Air Fry, Air Roast, or Whole Roast functions.
- If problem persists, run a Toast cycle on shade 7 with accessories removed; this will burn off any additional grease on the heating elements that are causing smoke.

How can I clean the sheet pan?

- For stuck-on food, let the sheet pan soak before cleaning.
- Line the sheet pan with aluminum foil or parchment paper when cooking to make clean-up easier.

Why did a circuit breaker trip while using the unit?

- The unit uses 1800 watts of power, so it must be plugged into an outlet on a 15-amp circuit breaker. It is also important that the unit be the only appliance plugged into an outlet when in use. To avoid tripping a breaker, make sure the unit is the only appliance plugged into an outlet on a 15-amp breaker.

Why does the unit sound like it is still running even though the power is off?

- The cooling fan may continue to run even after the unit has been turned off. This is a normal function and should not be a source of concern. The cooling fan will stop after the temperature of the unit reaches below 95°F (35°C).

The One (1) Year Limited Warranty applies to purchases made from authorized retailers of **SharkNinja Operating LLC**. Warranty coverage applies to the original owner and to the original product only and is not transferable.

SharkNinja warrants that the unit shall be free from defects in material and workmanship for a period of one (1) year from the date of purchase when it is used under normal household conditions and maintained according to the requirements outlined in the Owner's Guide, subject to the following conditions and exclusions:

What is covered by this warranty?

1. The original unit and/or non-wearable parts deemed defective, in SharkNinja's sole discretion, will be repaired or replaced up to one (1) year from the original purchase date.
2. In the event a replacement unit is issued, the warranty coverage ends six (6) months following the receipt date of the replacement unit or the remainder of the existing warranty, whichever is later. SharkNinja reserves the right to replace the unit with one of equal or greater value.

What is not covered by this warranty?

1. Normal wear and tear of wearable parts (such as blending vessels, lids, cups, blades, blender bases, removable pots, racks, pans, etc.), which require regular maintenance and/or replacement to ensure the proper functioning of your unit, are not covered by this warranty. Replacement parts are available for purchase at ninjaaccessories.com.
2. Any unit that has been tampered with or used for commercial purposes.
3. Damage caused by misuse, abuse, negligent handling, failure to perform required maintenance (e.g., failure to keep the well of the motor base clear of food spills and other debris), or damage due to mishandling in transit.
4. Consequential and incidental damages.
5. Defects caused by repair persons not authorized by SharkNinja. These defects include damages caused in the process of shipping, altering, or repairing the SharkNinja product (or any of its parts) when the repair is performed by a repair person not authorized by SharkNinja.
6. Products purchased, used, or operated outside North America.

How to get service

If your appliance fails to operate properly while in use under normal household conditions within the warranty period, visit ninjakitchen.com/support for product care and maintenance self-help. Our Customer Service Specialists are also available at **1-877-646-5288** to assist with product support and warranty service options, including the possibility of upgrading to our VIP warranty service options for select product categories. So we may better assist you, please register your product online at registeryourninja.com and have the product on hand when you call.

SharkNinja will cover the cost for the customer to send in the unit to us for repair or replacement. A fee of \$20.95 (subject to change) will be charged when SharkNinja ships the repaired or replacement unit.

How to initiate a warranty claim

You must call **1-877-646-5288** to initiate a warranty claim. You will need the receipt as proof of purchase. We also ask that you register your product online at registeryourninja.com and have the product on hand when you call, so we may better assist you. A Customer Service Specialist will provide you with return and packing instruction information.

How state law applies

This warranty gives you specific legal rights, and you also may have other rights that vary from state to state. Some states do not permit the exclusion or limitation of incidental or consequential damages, so the above may not apply to you.