

NINJA®

DZ302

OWNER'S GUIDE

Foodi

XL 2-BASKET AIR FRYER



ninjakitchen.com

THANK YOU

for purchasing the Ninja® Foodi® XL 2-Basket Air Fryer



REGISTER YOUR PURCHASE

 registeryourninja.com

 Scan QR code using mobile device

RECORD THIS INFORMATION

Model Number: _____

Serial Number: _____

Date of Purchase: _____
(Keep receipt)

Store of Purchase: _____

TECHNICAL SPECIFICATIONS

Voltage: 120V~, 60Hz

Watts: 1690W

TIP: You can find the model and serial numbers on the QR code label on the back of the unit by the power cord.

CONTENTS

Important Safeguards	2
Parts	4
Getting to Know Your Ninja® Foodi® 2-Basket Air Fryer	5
Function Buttons	5
Operating Buttons	5
Before First Use	5
Cooking in Your 2-Basket Air Fryer	6
Cooking with DualZone™ Technology	6
Ending the Cook Time in One Zone (while using both zones) ...	8
Pausing Both Zones at the Same Time	8
Pausing a Single Zone During DualZone Cooking	8
Cooking in a Single Zone	9
Air Fry	9
Air Broil	10
Roast	10
Keep Warm	11
Dehydrate	11
Bake	12
Cleaning Your 2-Basket Air Fryer	13
Helpful Tips	13
Replacement Parts	13
Troubleshooting Guide	14
Warranty	15

IMPORTANT SAFEGUARDS

HOUSEHOLD USE ONLY. READ ALL INSTRUCTIONS BEFORE USE.

When using electrical appliance, basic safety precautions should always be followed, including the following:

⚠ WARNINGS

- 1 To eliminate a choking hazard for young children, discard all packaging materials immediately upon unpacking.
- 2 This appliance can be used by persons with reduced physical, sensory or mental capabilities or lack of experience and knowledge if they have been given supervision or instruction concerning use of the appliance in a safe way and understand the hazards involved.
- 3 Keep the appliance and its cord out of reach of children. **DO NOT** allow the appliance to be used by children. Close supervision is necessary when used near children
- 4 Children should not play with the appliance.
- 5 **NEVER** use electrical socket below counter.
- 6 **NEVER** connect this appliance to an external timer switch or separate remote-control system.
- 7 When using this appliance, provide at least 6 inches (15.25 cm) of space above and on all sides for air circulation.
- 8 To protect against electrical shock **DO NOT** immerse cord, plugs, or main unit housing in water or other liquid. Cook only in the basket provided .
- 9 Regularly inspect the appliance and power cord. **DO NOT** use the appliance if there is damage to the power cord or plug. If the appliance malfunctions or has been damaged in any way, immediately stop use and call Customer Service.
- 10 **DO NOT** use an extension cord. A short power-supply cord is used to reduce the risk of children grabbing the cord or becoming entangled and to reduce the risk of people tripping over a longer cord.
- 11 **ALWAYS** ensure the appliance is properly assembled before use.
- 12 **DO NOT** cover the air intake vent or air outlet while unit is operating. Doing so will prevent even cooking and may damage the unit or cause it to overheat.
- 13 Before placing removable basket into the main unit, ensure basket and unit are clean and dry by wiping with a soft cloth.
- 14 This appliance is for household use only. **DO NOT** use this appliance for anything other than its intended use. **DO NOT** use in moving vehicles or boats. **DO NOT** use outdoors. Misuse may cause injury.
- 15 Intended for worktop use only. Ensure the surface is level, clean and dry. **DO NOT** move the appliance when in use.
- 16 **DO NOT** place the appliance near the edge of a worktop during operation.
- 17 **DO NOT** use accessory attachments not recommended or sold by SharkNinja. Do not place accessories in a microwave, toaster oven, convection oven, or conventional oven or on a ceramic cooktop, electric coil, gas burner range or outdoor grill. The use of accessory attachments not recommended by SharkNinja may cause fire, electric shock or injuries.
- 18 **ALWAYS** ensure basket is properly closed before operating.
- 19 **DO NOT** use the appliance without the removable basket installed.
- 20 **DO NOT** use this appliance for deep-frying.
- 21 **DO NOT** place appliance on hot surfaces, near hot gas or electric burner, in a heated oven, or on a stovetop.
- 22 Prevent food contact with heating elements. **DO NOT** overfill when cooking. Overfilling may cause personal injury or property damage or affect the safe use of the appliance.

- 23 **DO NOT** place or store anything on top of product when in use.
- 24 Socket voltages can vary, affecting the performance of your product. To prevent possible illness, use a thermometer to check that your food is cooked to the temperatures recommended.
- 25 Should the unit emit black smoke, unplug immediately. Wait for smoking to stop before removing any cooking accessories.
- 26 **DO NOT** touch hot surfaces. Appliance surfaces are hot during and after operation. To prevent burns or personal injury, **ALWAYS** use protective hot pads or insulated oven mitts and use available handles.
- 27 Extreme caution must be used when the appliance contains hot food. Improper use may result in personal injury.
- 28 This appliance has a polarized plug (one blade is wider than the other). To reduce the risk of electric shock, this plug is intended to fit into a polarized outlet only one way. If the plug does not fit fully into the outlet, reverse the plug. If it still does not fit, contact a qualified electrician. **DO NOT** attempt to modify the plug in any way.
- 29 Spilled food can cause serious burns. Keep appliance and cord away from children. **DO NOT** let cord hang over edges of tables or counters or touch hot surfaces.
- 30 The basket and crisper plate become extremely hot during the cooking process. Avoid physical contact while removing the basket or plate from the appliance. **ALWAYS** place basket or plate on a heat-resistant surface after removing. **DO NOT** touch accessories during or immediately after cooking.
- 31 Cleaning and user maintenance should not be carried out by children.
- 32 To disconnect, press the power button to turn off the unit, then unplug from socket when not in use and before cleaning. Allow to cool before cleaning, disassembly, putting in or taking off parts and storage.
- 33 **DO NOT** clean with metal scouring pads. Pieces can break off the pad and touch electrical parts, creating the risk of electric shock.
- 34 Please refer to the Cleaning & Maintenance section for regular maintenance of the appliance.



Indicates to read and review instructions to understand operation and use of product.



Indicates the presence of a hazard that can cause personal injury, death or substantial property damage if the warning included with this symbol is ignored.



Take care to avoid contact with hot surface. Always use hand protection to avoid burns.



For indoor and household use only.

SAVE THESE INSTRUCTIONS

PARTS

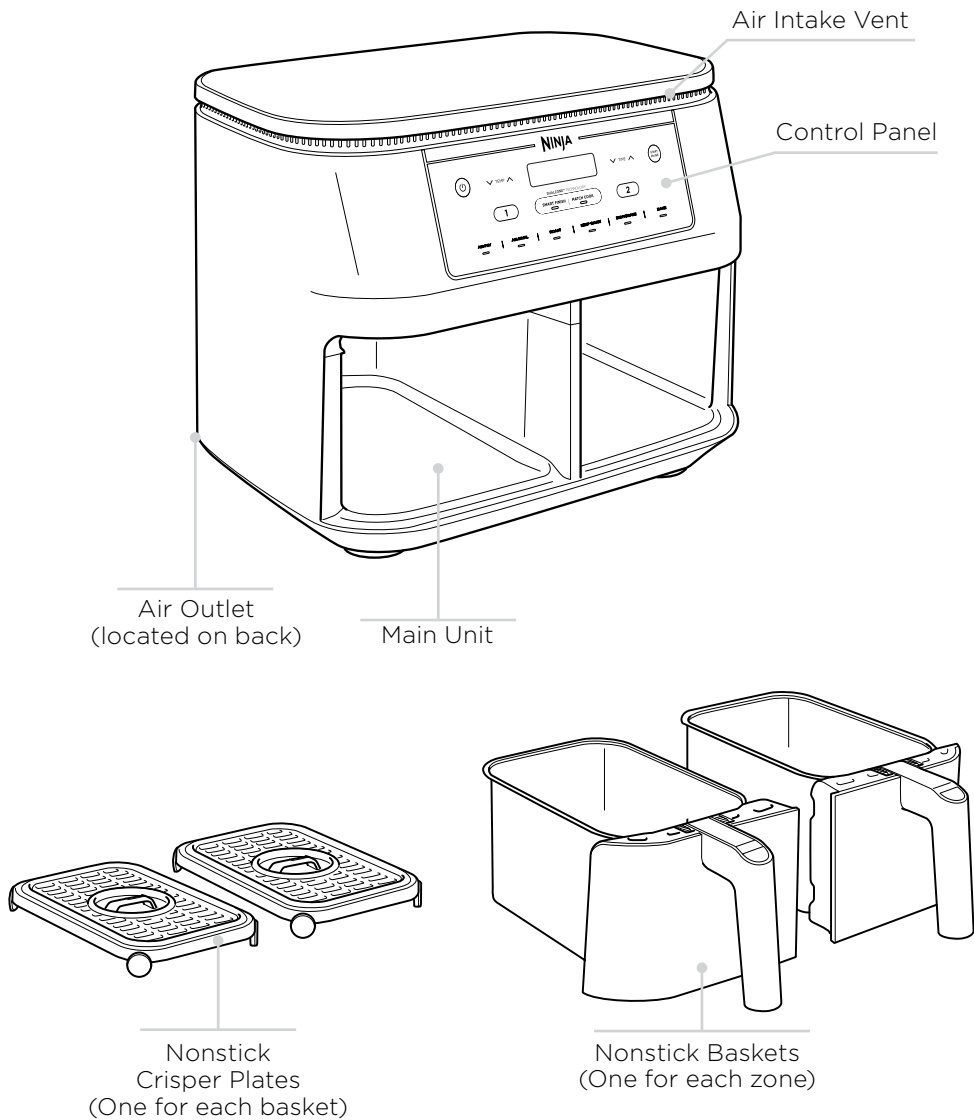

GETTING TO KNOW YOUR NINJA® FOODI® XL 2-BASKET AIR FRYER

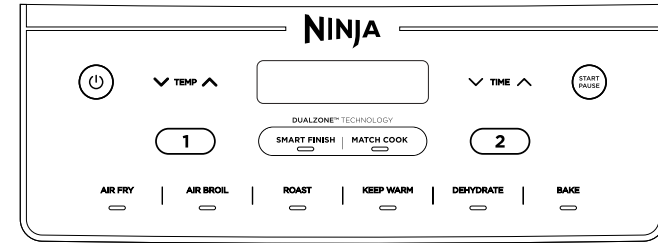

When setting time, the digital display shows HH:MM.

FUNCTION BUTTONS*

AIR FRY: Use this function to give your food crispiness and crunch with little to no oil.

AIR BROIL: Add the crispy finishing touch to meals, or melt toppings to create the perfect finish.

ROAST: Use the unit as a roaster oven for tender meats and more.

KEEP WARM: Use this function to keep food warm until ready for serving.

DEHYDRATE: Dehydrate meats, fruits, and vegetables for healthy snacks.

BAKE: Create decadent baked treats and desserts.

OPERATING BUTTONS

- ① Controls the output for the basket on the left.
- ② Controls the output for the basket on the right.

TEMP arrows: Use the up and down arrows to adjust the cook temperature before or during cooking.

TIME arrows: Use the up and down arrows to adjust the cook time in any function before or during the cook cycle.

SMART FINISH™ button: Automatically syncs the cook times to ensure both zones finish at the same time, even if there are different cook times.

MATCH COOK™ button: Automatically matches zone 2 settings to those of zone 1 to cook a larger amount of the same food, or cook different foods using the same function, temperature, and time.

START/PAUSE button: After selecting temperature and time, start cooking by pressing the START/PAUSE button. To pause cooking, first select the zone you would like to pause, then press the START/PAUSE button.

POWER BUTTON: The ⏻ button turns the unit on and off and stops all cooking functions.

Standby Mode: After 10 minutes of no interaction with the control panel, the unit will enter standby mode. The Power button will be dimly lit.

Hold Mode: Hold will appear on the unit while in SMART FINISH mode. One zone will be cooking, while the other zone will be holding until the times sync together

NOTE: Not all models include all functions

BEFORE FIRST USE

- 1 Remove and discard any packaging material, promotional labels, and tape from the unit.
- 2 Remove all accessories from the package and read this manual carefully. Please pay particular attention to operational instructions, warnings, and important safeguards to avoid any injury or property damage.
- 3 Wash the baskets and crisper plates in hot, soapy water, then rinse and dry thoroughly. The crisper plates and baskets are the **ONLY** dishwasher-safe parts. **NEVER** clean the main unit in the dishwasher.

COOKING IN YOUR 2-BASKET AIR FRYER

REFERENCE QUICK START GUIDE FOR RECIPES AND COOKING CHARTS

COOKING WITH DUALZONE™ TECHNOLOGY

DualZone Technology utilizes two cooking zones to increase versatility. The Smart Finish™ feature ensures that, regardless of different cook settings, both zones will finish ready to serve at the same time. For detailed instructions on using each function, see pages 10-13.

SMART FINISH

To finish cooking at the same time when foods have different cook times, temps, or even functions:

- 1 Place ingredients in the baskets, then insert baskets in unit.
- 2 Zone 1 will remain illuminated. Select the desired cooking function. Use the TEMP arrows to set the temperature, and use the TIME arrows to set the time.



- 3 Select zone 2, then select the desired cooking function. (AIR BROIL is not available if selected in zone 1) Use the TEMP arrows to set the temperature, and use the TIME arrows to set the time.



NOTE: You can select a different function for zone 2.

NOTE: Air Broil can only be used in one zone.

- 4 Press SMART FINISH, then press the START/PAUSE button to begin cooking in the zone with the longest time. The other zone will display **Hold**. The unit will beep and activate the second zone when both zones have the same time remaining.



NOTE: It is recommended to shake your food during cooking. To keep the time at a synchronized finish, press the START/PAUSE button to pause both zones. To pause a single zone during dual zone cooking, refer to page 8.

- 5 When cooking is complete, the unit will beep and “End” will appear on the display.

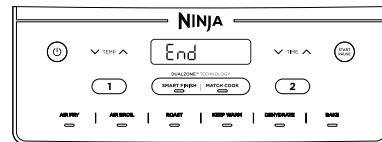

- 6 Remove ingredients by dumping them out or using silicone-tipped tongs/utensils. **DO NOT** place drawer on top of unit.

NOTE: If you decide the food in one of the zones is done cooking before the cook time is up, you can **STOP A ZONE**. Select that zone, then press START/PAUSE to pause the zone or set the time to zero. See page 11 for further instructions.

MATCH COOK™

To cook a larger amount of the same food, or cook different foods using the same function, temperature, and time:

- 1 Place ingredients in the baskets, then insert baskets in unit.
- 2 Zone 1 will remain illuminated. Select the desired cooking function. (AIR BROIL is not available with this function.) Use the TEMP arrows to set the temperature, and use the TIME arrows to set the time.



- 3 Press the MATCH COOK button to copy the zone 1 settings to zone 2. Then Press START/PAUSE to begin cooking in both zones.

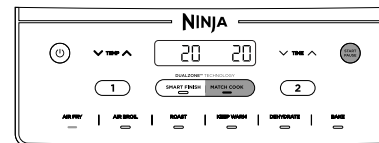

NOTE: It is recommended to shake your food during cooking. To keep the time at a synchronized finish, press the START/PAUSE button to pause both zones. To pause a single zone during dual zone cooking, refer to page 8.

- 4 “End” will appear on both screens when cooking ends at the same time.

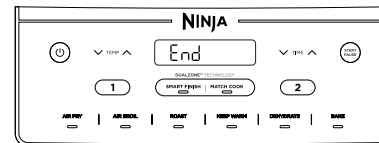

- 5 Remove ingredients by dumping them out or using silicone-tipped tongs/utensils.

NOTE: Air Broil cannot be used in Match Cook mode.

Starting both zones at the same time, but ending at different times:

- 1 Select zone 1, then select the desired function. Use the TEMP arrows to set the temperature.



- 2 Use the TIME arrows to set the time.

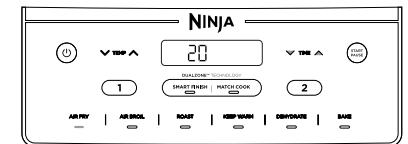

- 3 Repeat steps 2 and 3 for zone 2. (AIR BROIL is not available if programmed in zone 1.)



- 4 Press the START/PAUSE button to begin cooking in both zones.



NOTE: If you decide the food in one of the zones is done cooking before the cook time is up, you can **STOP A ZONE**. Select that zone, then press START/PAUSE to pause the zone or set the time to zero. See page 11 for further instructions.

- 5 When cooking is complete in each zone, the unit will beep and “End” will appear on the display.

- 6 Remove ingredients by dumping them out or using silicone-tipped tongs/utensils.

COOKING IN YOUR 2-BASKET AIR FRYER - CONT.

ENDING THE COOK TIME IN ONE ZONE (WHILE USING BOTH ZONES)

- 1 Select the zone you would like to stop.

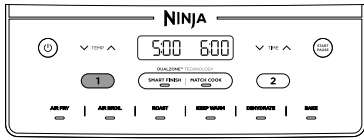

- 2 Then press the down TIME arrow to set the time to zero.



- 3 Once you have set the time to zero, press the START/PAUSE button.
- 4 The time in that zone is then canceled, and "End" will appear on the display. Cooking will continue in the other zone.

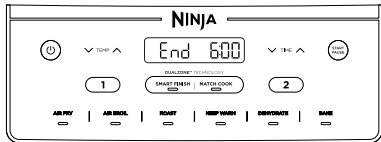

PAUSING BOTH ZONES AT THE SAME TIME

- 1 To pause time in the SMART FINISH™ mode, or to pause both zones in dual zone cooking, press the START/PAUSE button.

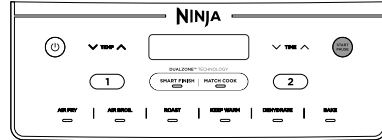

- 2 To resume cooking, press the START/PAUSE button again.

PAUSING A SINGLE ZONE DURING DUALZONE™ COOKING

- 1 To pause time in a single zone while both zones are running, select the zone you want to pause, then press the START/PAUSE button.

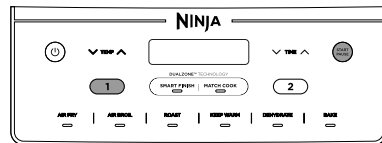

- 2 To resume cooking, press the START/PAUSE button again.

COOKING IN A SINGLE ZONE

For instructions on using both zones at the same time, see pages 6-7.

To turn on the unit, plug the power cord into a wall outlet, then press the power button.

Air Fry

- 1 Install crisper plate in the basket, then place ingredients in the basket, and insert basket in unit.

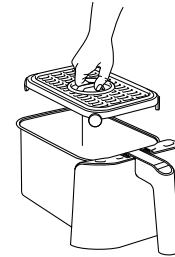

- 2 The unit will default to zone 1 (to use zone 2 instead, select zone 2). Select AIR FRY.



- 3 Use the TEMP arrows to set the desired temperature.

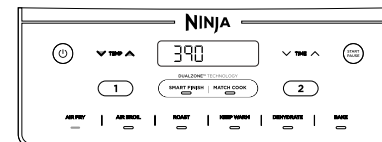

- 4 Use the TIME arrows to set the time in 1-minute increments up to 1 hour. Press the START/PAUSE button to begin cooking.

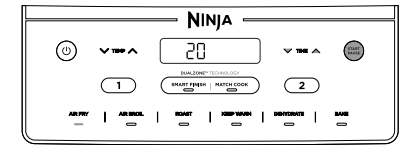

NOTE: During cooking, you can remove the basket and shake or toss ingredients for evening crisping. If you would like to pause during this time, press the zone number then START/PAUSE. If using a single zone, press START/PAUSE.

- 5 When cooking is complete, the unit will beep and "End" will appear on the display.

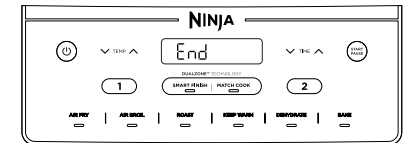

- 6 Remove ingredients by dumping them out or using silicone-tipped tongs/utensils.

COOKING IN YOUR 2-BASKET AIR FRYER - CONT.

Air Broil

NOTE: AIR BROIL cannot be used in both zones at the same time.

- 1 Install crisper plate in the basket, then add the broil rack on top of the plate. Use the broil rack for best air broil results and for an extra layer of cooking.



- 2 The unit will default to zone 1 (to use zone 2 instead, select zone 2). Select AIR BROIL.



- 3 Use the TEMP arrows to set the desired temperature.



- 4 Use the TIME arrows to set the time in 1-minute increments up to 30 minutes. Press the START/PAUSE button to begin cooking.

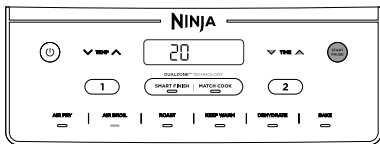

- 5 When cooking is complete, the unit will beep and "End" will appear on the display.

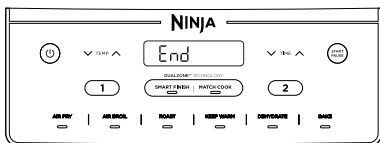

- 6 Remove ingredients by dumping them out or using silicone-tipped tongs/utensils.

Roast

- 1 Install crisper plate in the basket (optional), then place ingredients in the basket, and insert basket in unit.



- 2 The unit will default to zone 1 (to use zone 2 instead, select zone 2). Select ROAST.



- 3 Use the TEMP arrows to set the desired temperature.



- 4 Use the TIME arrows to set the time in 1-minute increments up to 1 hour and in 5-minute increments from 1 to 4 hours. Press the START/PAUSE button to begin cooking.



- 5 When cooking is complete, the unit will beep and "End" will appear on the display.

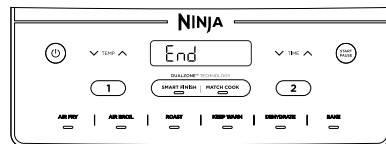

- 6 Remove ingredients by dumping them out or using silicone-tipped tongs/utensils.

Keep Warm (Not available on all models.)

NOTE: Use this function to keep food warm until ready for serving.

- 1 Install crisper plate in the basket, then place already cooked food in the basket, and insert basket in unit.

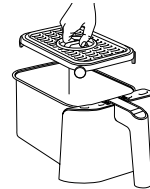

- 2 The unit will default to zone 1 (to use zone 2 instead, select zone 2). Select KEEP WARM.



- 3 Temp will default to 140F to ensure food is kept warm at safe temperature.

NOTE: Temp can't be adjusted in KEEP WARM mode.



- 4 Timer will count up from 00:00..



- 5 Remove ingredients by dumping them out or using silicone-tipped tongs/utensils.

Dehydrate

- 1 Place a single layer of ingredients in the basket. Then install the crisper plate in the basket on top of the ingredients and place another layer of ingredients on the crisper plate.
- 2 The unit will default to zone 1 (to use zone 2 instead, select zone 2). Select DEHYDRATE. The default temperature will appear on the display. Use the TEMP arrows to set the desired temperature.



- 3 Use the TIME arrows to set the time in 15-minute increments from 1 to 12 hours. Press the START/PAUSE button to begin dehydrating.

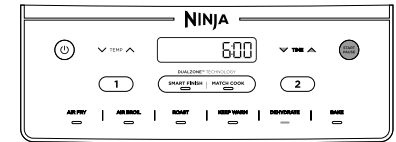

- 4 When cooking is complete, the unit will beep and "End" will appear on the display.



- 5 Remove ingredients by dumping them out or using silicone-tipped tongs/utensils.

COOKING IN YOUR 2-BASKET AIR FRYER – CONT.

Bake

- 1 For baked goods, remove crisper plate from the basket, then place ingredients directly in the basket, and insert basket in unit.
- 2 Install crisper plate in the basket (optional), then place ingredients in the basket, and insert basket in unit.



NOTE: To convert recipes from a traditional oven, reduce the temperature by 25°F.

- 3 The unit will default to zone 1 (to use zone 2 instead, select zone 2). Select BAKE.



- 4 Use the TEMP arrows to set the desired temperature.

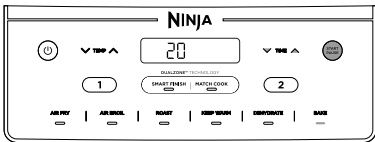

- 5 Use the TIME arrows to set the time in 1-minute increments up to 1 hour and in 5-minute increments from 1 to 4 hours. Press the START/PAUSE button to begin cooking.



- 6 When cooking is complete, the unit will beep and “End” will appear on the display.
- 7 Remove ingredients by dumping them out or using silicone-tipped tongs/utensils.

CLEANING YOUR 2-BASKET AIR FRYER

The unit should be cleaned thoroughly after every use. Unplug the unit from the wall outlet before cleaning.

Part/Accessory	Cleaning Method	Dishwasher Safe?
Main Unit	To clean the main unit and the control panel, wipe them clean with a damp cloth. NOTE: NEVER immerse the main unit in water or any other liquid. NEVER clean the main unit in a dishwasher.	No
Crisper Plates	The crisper plates can be washed in the dishwasher or by hand. If hand-washing, air-dry or towel-dry all parts after use.	Yes
Baskets	The baskets can be washed in the dishwasher or by hand. If hand-washing, air-dry or towel-dry all parts after use. *To extend the life of your basket, we recommend hand-washing them.	Yes*

If food residue is stuck on the crisper plates or baskets, place them in a sink filled with warm, soapy water and allow to soak.

HELPFUL TIPS

- 1 For consistent browning, make sure ingredients are arranged in an even layer on the bottom of the basket with no overlapping. If ingredients are overlapping, make sure to shake them halfway through cooking.
- 2 Cook temperature and time can be adjusted at any time during cooking. Simply select the zone you want to adjust, then press the TEMP arrows to adjust the temperature or the TIME arrows to adjust the time.
- 3 To convert recipes from a traditional oven, reduce the temperature by 25°F. Check food frequently to avoid overcooking.
- 4 Occasionally, the fan from the air fryer will blow lightweight foods around. To alleviate this, secure foods (like the top slice of bread on a sandwich) with wooden toothpicks.
- 5 The crisper plates elevate ingredients in the baskets so air can circulate under and around ingredients for even, crisp results.
- 6 After selecting a cooking function, you can press the START/PAUSE button to begin cooking immediately. The unit will run at the default temperature and time.
- 7 For best results with fresh vegetables and potatoes, use at least 1 tablespoon of oil. Add more oil as desired to achieve the preferred level of crispiness.
- 8 For best results, check progress throughout cooking and remove food when desired level of brownness has been achieved. We recommend using an instant-read thermometer to monitor the internal temperature of proteins.
- 9 For best results, remove food directly after the cook time is complete to avoid overcooking.

REPLACEMENT PARTS

To order additional parts and accessories, visit ninjaccessories.com or contact Customer Service at 1-877-646-5288.

TROUBLESHOOTING GUIDE

- **How do I adjust the temperature or time while using a single zone?**
When a single zone is running the time or temperature can be adjusted at any time by pressing the up/down arrows.
- **How do I adjust the temperature or time while using both zones?**
Select the desired zone, then use the TEMP arrows to adjust the temperature or the TIME arrows to adjust the time.
- **Can I cook different foods in each zone and not worry about cross contamination?**
Yes, both zones are self-contained with separate heating elements and fans.
- **How do I pause or stop one zone when using both zones?**
Select the zone you want to pause or stop, then press the START/PAUSE button or set the time to zero.
- **Are the baskets safe to put on my countertop?**
The baskets will heat up during cooking. Use caution when handling, and place them on heat-safe surfaces only. **DO NOT** place the baskets on the top of the unit.
- **When should I use the crisper plate?**
Use the crisper plate when you want food to come out crispy. The plate elevates the food in the basket so that air can flow under and around it to cook ingredients evenly.
- **Why didn't my food cook fully?**
Make sure the basket is fully inserted during cooking. For consistent browning, make sure ingredients are arranged in an even layer on the bottom of the basket with no overlapping. Shake basket to toss ingredients for even crispiness. Cook temperature and time can be adjusted at any time during cooking. Simply use the TEMP arrows to adjust the temperature or the TIME arrows to adjust the time.
- **Why is my food burned?**
For best results, check progress throughout cooking and remove food when desired level of brownness has been achieved. Remove food immediately after the cook time is complete to avoid overcooking.
- **Why do some ingredients blow around when air frying?**
Occasionally, the fan from the air fryer will blow lightweight foods around. Use wooden toothpicks to secure loose lightweight food, like the top slice of bread on a sandwich.
- **Can I air fry wet, battered ingredients?**
Yes, but use the proper breading technique. It is important to coat foods first with flour, then with egg, and then with bread crumbs. Press breading firmly onto the battered ingredients, so crumbs won't be blown off by the fan.
- **Why did the display screen go black?**
The unit is in standby mode. Press the power @ button to turn it back on.
- **Why is the unit beeping?**
Either the food is done cooking, or the other zone has started cooking.
- **Why is there an "E" message on the display screen?**
The unit is not functioning properly. Please contact Customer Service at 1-877-646-5288.
- **Why did a circuit breaker trip while using the unit?**
The unit uses 1690 watts of power, so it must be plugged into an outlet on a 15-amp circuit breaker. Using an outlet on a 10-amp breaker will cause the breaker to trip. It is also important that the unit be the only appliance plugged into an outlet when in use. To avoid tripping a breaker, make sure the unit is the only appliance plugged into an outlet on a 15-amp breaker

Shark | NINJA

ONE (1) YEAR LIMITED WARRANTY

NJA_1_YR_IB_LMTD_WRNTY_US_ENG

The One (1) Year Limited Warranty applies to purchases made from authorized retailers of **SharkNinja Operating LLC**. Warranty coverage applies to the original owner and to the original product only and is not transferable.

SharkNinja warrants that the unit shall be free from defects in material and workmanship for a period of one (1) year from the date of purchase when it is used under normal household conditions and maintained according to the requirements outlined in the Owner's Guide, subject to the following conditions and exclusions:

What is covered by this warranty?

1. The original unit and/or non-wearable parts deemed defective, in SharkNinja's sole discretion, will be repaired or replaced up to one (1) year from the original purchase date.
2. In the event a replacement unit is issued, the warranty coverage ends six (6) months following the receipt date of the replacement unit or the remainder of the existing warranty, whichever is later. SharkNinja reserves the right to replace the unit with one of equal or greater value.

What is not covered by this warranty?

1. Normal wear and tear of wearable parts (such as blending vessels, lids, cups, blades, blender bases, removable pots, racks, pans, etc.), which require regular maintenance and/or replacement to ensure the proper functioning of your unit, are not covered by this warranty. Replacement parts are available for purchase at ninjaaccessories.com.
2. Any unit that has been tampered with or used for commercial purposes.
3. Damage caused by misuse, abuse, negligent handling, failure to perform required maintenance (e.g., failure to keep the well of the motor base clear of food spills and other debris), or damage due to mishandling in transit.
4. Consequential and incidental damages.
5. Defects caused by repair persons not authorized by SharkNinja. These defects include damages caused in the process of shipping, altering, or repairing the SharkNinja product (or any of its parts) when the repair is performed by a repair person not authorized by SharkNinja.
6. Products purchased, used, or operated outside North America.

How to get service

If your appliance fails to operate properly while in use under normal household conditions within the warranty period, visit ninjakitchen.com/support for product care and maintenance self-help. Our Customer Service Specialists are also available at **1-877-646-5288** to assist with product support and warranty service options, including the possibility of upgrading to our VIP warranty service options for select product categories. So we may better assist you, please register your product online at registryourninja.com and have the product on hand when you call.

SharkNinja will cover the cost for the customer to send in the unit to us for repair or replacement. A fee of \$20.95 (subject to change) will be charged when SharkNinja ships the repaired or replacement unit.

How to initiate a warranty claim

You must call **1-877-646-5288** to initiate a warranty claim. You will need the receipt as proof of purchase. We also ask that you register your product online at registryourninja.com and have the product on hand when you call, so we may better assist you. A Customer Service Specialist will provide you with return and packing instruction information.

How state law applies

This warranty gives you specific legal rights, and you also may have other rights that vary from state to state. Some states do not permit the exclusion or limitation of incidental or consequential damages, so the above may not apply to you.

SharkNinja Operating LLC
US: Needham, MA 02494
1-877-646-5288
ninjakitchen.com

Illustrations may differ from actual product. We are constantly striving to improve our products, therefore the specifications contained herein are subject to change without notice.

FOODI and NINJA are registered trademarks of SharkNinja Operating LLC.

DUALZONE, MATCH COOK, and SMART FINISH are trademarks of SharkNinja Operating LLC.

This product may be covered by one or more U.S. patents. See sharkninja.com/patents for more information.

© 2023 SharkNinja Operating LLC

PRINTED IN CHINA

DZ302_IB_MP_Mv4



@ninjakitchen