



# NINJA WOODFIRE™ PRO XL OUTDOOR GRILL & SMOKER WITH BUILT-IN THERMOMETER

OG900 Series | Owner's Guide



## IMPORTANT SAFETY INSTRUCTIONS

OUTDOOR HOUSEHOLD USE ONLY. READ ALL INSTRUCTIONS BEFORE USE



Read and review instructions to understand operation and use of product.



Indicates the presence of a hazard that can cause personal injury, death or substantial property damage if the warning included with this symbol is ignored.



Avoid contact with hot surface. Always use hand protection to avoid burns.

### **⚠️ WARNING**

Failure to follow these instructions could result in electric shock, fire or burn hazard which could cause property damage, personal injury, or death. When using electrical appliances, basic safety precautions should always be followed, including the following:

- 1 To eliminate a choking hazard for young children, discard all packaging materials immediately upon unpacking.
- 2 This appliance is for outdoor household use only.
- 3 **DO NOT** use this appliance for anything other than its intended use. Misuse may cause injury.
- 4 **DO NOT** operate this appliance unattended.
- 5 **DO NOT** use in moving vehicles or boats.
- 6 This appliance can be used by persons with reduced physical, sensory, or mental capabilities or lack of experience and knowledge if they have been given supervision or instruction concerning use of the appliance in a safe way and understand the hazards involved.
- 7 To avoid property damage from flame or heat maintain a minimum distance of 3 feet from rear, sides and top to walls, rails, or other combustible constructions.
- 8 To avoid property damage and burn injury from flame or heat, **ALWAYS** maintain a minimum safe distance of at least 1 foot (30 cm) from the pellet box during smoking. Small flames can come out from the pellet box if the grill lid is lifted in windy conditions.
- 9 To avoid burn injury, **DO NOT** lean over grill while cooking.
- 10 **DO NOT** place on or near a hot gas or electric burner, or in a heated oven.
- 11 **ALWAYS** use pellet scoop when adding pellets to smoker box. **DO NOT** add pellets by hand.
- 12 To avoid burn injury and property damage, make sure the lid of the smoke box is fully closed to prevent flames from escaping out of the smoke box.
- 13 Pellets may continue to burn after cook time is complete. **DO NOT** touch or remove the smoke box until the grill has stopped smoking, pellets have completely burnt out, and the smoke box has cooled.
- 14 To avoid personal injury and burns allow to cool before cleaning, disassembly, putting in or taking off parts and storage.
- 15 **DO NOT** allow pellets to overflow the pellet box. Doing so will introduce oxygen leading to combustion, flame, and damage to the unit which may result in burn injury.
- 16 **DO NOT** touch hot surfaces. Appliance surfaces are hot during and after operation. To prevent burns or personal injury, **ALWAYS** use protective hot pads or insulated oven mitts and use available handles and knobs.
- 17 **DO NOT** touch accessories during or immediately after cooking. The basket will become extremely hot during the cooking process. Avoid physical contact while removing the accessory from the appliance. To prevent burns or personal injury **ALWAYS** use care when interfacing with product. Recommend use of long handed utensil and protective hot pads or insulated oven mitts.
- 18 Ensure the surface is level, stable, clean and dry. **DO NOT** place the appliance near the edge of the surface the grill is placed on during operation.
- 19 Keep the appliance and its cord out of reach of children. **DO NOT** allow the appliance to be used near, cleaned, or maintained by children. Close supervision is necessary when used near children.
- 20 **CONNECT ONLY TO GFCI GROUNDED ELECTRICAL OUTLET IF USING AN EXTENSION CORD**

# IMPORTANT SAFETY INSTRUCTIONS

OUTDOOR HOUSEHOLD USE ONLY. READ ALL INSTRUCTIONS BEFORE USE

## ⚠ WARNING

Failure to follow these instructions could result in electric shock, fire or burn hazard which could cause property damage, personal injury, or death. When using electrical appliances, basic safety precautions should always be followed, including the following:

- 21 A short power-supply cord is provided to reduce the risk of children less than 8 years grabbing the cord or becoming entangled and to reduce the risk of people tripping over a longer cord. When using an extension cord it must be specific for use outdoors and must have a "W" marking and tag stating: **SUITABLE FOR USE WITH OUTDOOR APPLIANCES.**
- 22 **ALWAYS** ensure the grill is completely cool before releasing and removing the cooking plates or moving the to avoid burns or personal injury.
- 23 **DO NOT** use the appliance without the grill plate installed.
- 24 To protect against electrical shock, keep the cord connection dry and **DO NOT** immerse cord, plugs, or main unit housing in water or other liquid.
- 25 Regularly inspect the appliance and power cord. **DO NOT** use the appliance if there is damage to the power cord or plug. If the appliance malfunctions or has been damaged in any way, immediately stop use and call Customer Service.
- 26 **NEVER** use outlet below countertop surface.
- 27 **ALWAYS** ensure the appliance is properly assembled before use. **DO NOT** use without side handles attached.
- 28 **NEVER** connect this appliance to an external timer switch or separate remote-control system.
- 29 **DO NOT** place appliance and let cord hang over edges of tables, counters or touch hot surfaces.
- 30 Only use recommended accessories included with this appliance or authorized by SharkNinja. The use of accessories or attachments not recommended by SharkNinja may cause a risk of fire or injury.
- 31 Before placing any accessory into the cooker, ensure they are clean and dry.
- 32 **DO NOT** move the appliance when in use.
- 33 **DO NOT** cover the air intake vent or air outlet vent while unit is operating. Doing so will prevent even cooking and may damage the unit or cause it to overheat.
- 34 **DO NOT** place anything on top of the product when the hood is closed during use and stored.
- 35 Ensure the grill plate is correctly inserted and securely locked into position.
- 36 **DO NOT** use this appliance for deep-frying.
- 37 Some foods may cause oils or grease to splash. Use care when opening the grill to avoid burns.
- 38 Should a grease fire occur, or the unit emits black smoke, unplug immediately. Wait for smoking to stop before removing any cooking accessories.
- 39 Socket voltages can vary, affecting the performance of your product. To prevent possible illness, **ALWAYS** use an external food thermometer to check that your food is cooked to the recommended temperatures.
- 40 **DO NOT** use heating or any other non-food-grade pellets in the grill, due to potential hazardous contaminants and additives that may be present.
- 41 **DO NOT** use heating or any other non-food-grade pellets in the grill, due to potential hazardous contaminants and additives that may be present.
- 42 **NEVER** use heating fuel pellets, hardwood, charcoal, liquid fuels, or any other combustible material in the Smoker.
- 43 Keep hands and face away from Smoker Box when unit is in use and hot.
- 44 **ALWAYS** keep a fire extinguisher accessible while operating the smoker.
- 45 **ALWAYS** store wood pellets in a dry location, away from heat-producing appliances and other fuel containers.
- 46 Keep your grill clean. **DO NOT** allow excess grease or ash to collect inside the grease tray, or on the smoke box and cartridge. Doing so significantly increases the chances of a grease fire and additional smoke which can taint the flavor of your food.
- 47 Please refer to the Cleaning & Maintenance section for regular maintenance of the appliance.
- 48 To disconnect, press the power button to turn the unit off, then unplug from socket when not in use and before cleaning.
- 49 **DO NOT** clean with metal scouring pads. Pieces can break off the pad and touch electrical parts, creating a risk of electric shock.
- 50 When storing and not in use, keep out of reach of children.
- 51 Keep grill covered when not in use.

## SAVE THESE INSTRUCTIONS

## PARTS & ACCESSORIES

- A Grill Grate
- B Crisper Basket
- C Smoke Box
- D Grease Tray
- E Grease Tray Liner
- F Pellet Scoop
- G Main Unit (power cord not shown)
- H Hood
- I Control Panel
- J Onboard Thermometer storage
- K Built-in Thermometer(s) (not all models include two thermometers)

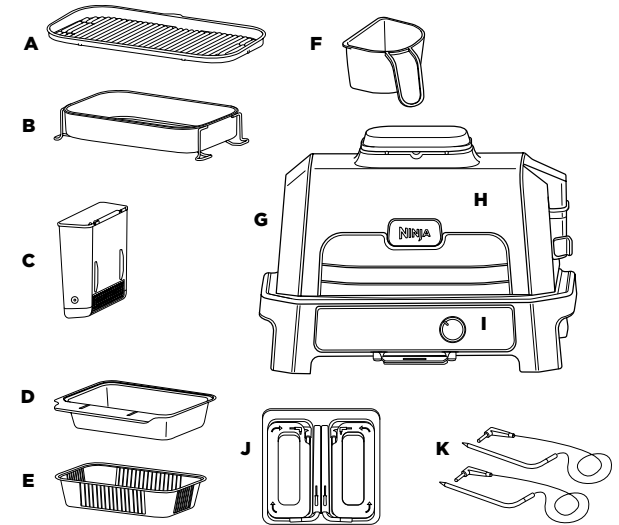

**NOTE:** Included accessories may vary by model.

## BEFORE FIRST USE

- 1 Remove all packaging material, and tape from the unit.
- 2 Remove all accessories from the package and read this manual carefully. Please pay particular attention to operational instructions, warnings, and important safeguards to avoid any injury or property damage.
- 3 Wash the grill grate and crisper basket in warm, soapy water, then rinse and dry thoroughly. The grill grate, crisper basket and base unit are **NOT** dishwasher safe. **NEVER** clean the main unit in the dishwasher.
- 4 **DO NOT** use abrasive brushes or sponges on the cooking surfaces, as it will cause damage to the coating.

We recommend placing all accessories inside the grill and running it on GRILL, temp set to HI for 20 minutes without adding food. This removes any residues. This is completely safe and not detrimental to the performance of the grill.

## EXTENSION CORD

- 1 Connect to properly 3-prong grounded GFCI outlets only.
- 2 Use only outdoor extension cords marked as "SJOW" and "suitable for use with outdoor appliances." For cords up to 25 feet, use 14-gauge. For 25 to 50-foot cords, use 12-gauge. Cords longer than 50 feet are not recommended. Using the incorrect cord could lead to the cord overheating, melting, and/or a drop in voltage. A drop in voltage can increase preheat times and impact cooking performance and/or cook times.

# GETTING TO KNOW THE NINJA WOODFIRE™ PRO XL OUTDOOR GRILL & SMOKER WITH BUILT-IN THERMOMETER

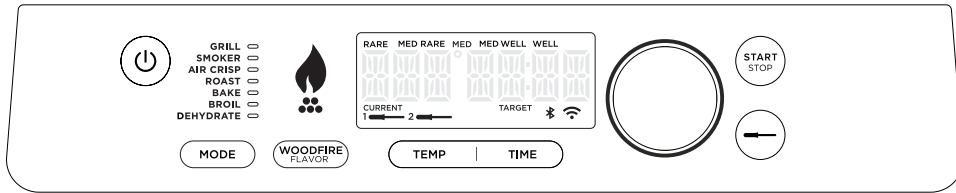

**NOTE:** Not all functions included with every model.

## FUNCTION BUTTONS

**GRILL:** Closed-hood cooking for top and bottom heat. Best when grilling large or thick cuts of meat or frozen food or for an all-around sear. Open the hood while grilling delicate foods or lean proteins to develop char-grilled textures without overcooking.

**SMOKER:** Create deep, smoky flavors while cooking low and slow to tenderize large cuts of meat.

**AIR CRISP:** Achieve crispiness and crunch with little to no oil and higher fan speeds.

**BAKE:** Bake cakes, treats, desserts, and more with lower fan speeds.

**ROAST:** Tenderize meats, roast vegetables, and more.

**BROIL:** Add a crispy finishing touch to meals or melt cheese on sandwiches.

**DEHYDRATE:** Dehydrate meats, fruits, and vegetables for healthy snacks.

## OPERATING BUTTONS

**DIAL:** Use the dial to adjust your temperature, cook time, or thermometer settings.

**NOTE:** When the unit is powered on, the display will be illuminated.

**WOODFIRE FLAVOR:** Press after selecting your cooking function to add authentic smoky flavors. Intended for use with the Grill, Air Crisp, Bake, Roast, and Dehydrate functions. When pressed, flame icon will illuminate on the display screen.

**NOTE:** Ninja Woodfire Flavor is automatically enabled when using the Smoker function.

**TEMP:** Press TEMP to change the grill temperature, use the dial to increase or decrease temperature.

**TIME:** Press TIME to change the cook time, use the dial to increase or decrease time.

**START/STOP:** Press to start or stop the current cook function, or press and hold for 4 seconds to skip preheat.

## PREHEAT FOR BETTER RESULTS

For best grilling results, let the grill fully preheat before adding food. Adding food before preheating is complete may lead to overcooking, smoke, and longer preheat time.

After you set function, time, and temperature then press START/STOP, the unit will automatically begin preheating (except if using the Smoker/Broil function or the Dehydrate function without enabling Ninja Woodfire Flavor).

## SMOKE BOX

Comes fully installed in the unit. Located on the right side of the hood. Always ensure the removable smoke box is inserted into place before adding pellets. Review all warnings before proceeding.



### Installing the smoke box:

To install, pull the smoke box open with one hand and insert the removable smoke box so it sits into place.



### Adding Ninja Woodfire™ Pellets:

Fill the pellet scoop to the top and level off to avoid spilling. While holding the smoke box open, use the pellet scoop to pour pellets into the smoke box until filled to the top. Then, close the smoke box.

Use only Ninja Woodfire Pellets for best results, performance, and flavor.



### Removing the smoke box and cleaning:

To avoid burns, allow pellets to burn completely and the smoke box to cool completely, then remove smoke box and safely discard all contents.

## USING THE BUILT-IN THERMOMETER(S)

**IMPORTANT: DO NOT** place hands near built-in thermometer(s) cord(s) when in use to prevent burning or scalding.

### Before First Use

Make sure the thermometer jack is free of any residue and the cord is free of knots before plugging it into the jack.

- Slide out the thermometer storage compartment from under the control panel, then unwind the cord from the compartment to remove the thermometer.

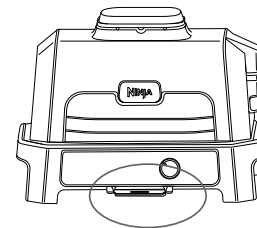

- Plug the thermometer into the top jack labeled "1" on the left side of the control panel. Push firmly on the plug until it cannot go into the jack any further. Slide the storage compartment back.
- After the thermometer is plugged into the jack, select the desired cook function and cook temperature.

**NOTE:** There is no need to set a cook time, as the grill will automatically turn off the heating element and alert you when your food has finished cooking.

- Press the Thermometer button, then use the dial to select your desired protein type or Manual. Press dial to confirm selection.
- Use the dial to select your desired doneness or manual internal temperature, then press dial to confirm selection.

### NOTE: Cooking different proteins or the same ones to different doneness?

Use the **second thermometer**. Plug into the jack labeled "2". Press the Thermometer button again. The thermometer 2 icon will flash. Repeat steps 3-5 to program the second thermometer.

## USING THE BUILT-IN THERMOMETER(S) - CONT'D

If selecting MANUAL, use the below recommended internal cook temperatures.

FOOD TYPE:	SET DONENESS TO:
Fish	Medium (130°F)
	Medium Well (140°F)
	Well Done (150°F)
Chicken/Turkey	Well Done (165°F)
Pork	Medium (130°F)
	Medium Well (150°F)
	Well Done (160°F)
Beef/Lamb	Rare (115°F)
	Medium Rare (125°F)
	Medium (130°F)
	Medium Well (145°F)
	Well Done (150°F)

**NOTE:** Reference USDA guidelines for food-safe temperature recommendations.

**NOTE:** Preset doneness temperatures for BEEF/LAMB are lower than normal recommendations, as unit will carry-over cook 10-15°F.

- Place the accessory required for your selected cook function in the grill and close the hood. Press START/STOP to begin preheating.
- While the grill is preheating, insert the thermometer horizontally into the center of the thickest part of the piece of protein. **Refer to the chart on the next page for further thermometer placement instructions.**
- When the grill has preheated and "ADD FOOD" appears on the screen, open the hood, place food with inserted thermometer in the unit, and close the hood over the thermometer cord.

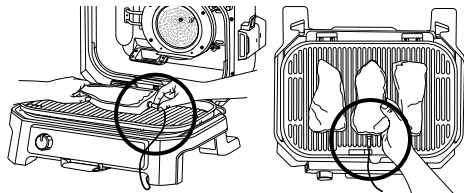

Correct thermometer placement. Thermometer grip is fully inside unit.

- The progress bar at the top of the display will track doneness. Flashing doneness indicates progression to that doneness.

RARE > MED RARE < MED MED WELL WELL

**NOTE:** When using Grill and Roast, the unit will beep and display FLIP. Flipping is optional, but recommended.

- The grill will automatically stop when desired doneness is almost reached, as it accounts for carry-over cooking, and "GET FOOD" will display on the screen.
- Transfer the protein to a plate while "REST" displays on the screen. Thermometer does not need to still be inserted. The protein will continue to carry-over cook to your set doneness, which will take about 3-5 minutes. This is an important step, as not resting could lead to results looking less cooked. Carry-over cook times can vary based on size of protein, cut of protein, and type of protein.

**NOTE:** The thermometer will be HOT. Use either oven mitts or tongs to take the thermometer out of the protein.

**NOTE:** To check the internal temperature of other pieces of protein, press and hold the Thermometer button and insert the thermometer into each piece of meat.

## HOW TO CORRECTLY INSERT THE THERMOMETER

FOOD TYPE:	PLACEMENT	CORRECT	INCORRECT
<b>Steaks</b> <b>Pork chops</b> <b>Lamb chops</b> <b>Chicken breasts</b> <b>Burgers</b> <b>Tenderloins</b> <b>Fish fillets</b>	<ul style="list-style-type: none"> <li>Insert thermometer horizontally into the center of the thickest part of the meat.</li> <li>Make sure the thermometer is close to (but not touching) the bone and away from any fat or gristle.</li> <li>Make sure the tip of the thermometer is inserted straight into the center of the meat, not angled toward the bottom or top of it.</li> </ul> <p><b>NOTE:</b> The thickest part of the fillet may not be the center. It is important that the end of the thermometer hits this area so that desired results are achieved.</p>		
<b>Whole chicken</b>	<ul style="list-style-type: none"> <li>Insert thermometer horizontally into the thickest part of the breast, parallel to (but not touching) the bone.</li> <li>Make sure the tip reaches the center of the thickest part of the breast and doesn't go all the way through the breast into the cavity.</li> </ul>		

**NOTE: DO NOT** use the thermometer with frozen protein or for cuts of meat thinner than 1 inch.



## COOKING FUNCTIONS

**IMPORTANT:** Review all warnings at the beginning of this Owner's Guide before proceeding.

### Grill

- 1 Place grill on a flat, level surface.
- 2 Open the hood and install the grill grate by positioning it flat on top of the heating element so it sits in place.

**NOTE:** If you are using the thermometer, refer to the Using the Built-In Thermometer(s) section.

- 3 Install the grease tray by sliding it into place at the back of the grill.
- 4  If you plan to add Ninja Woodfire Flavor, pull the smoke box open and use the pellet scoop to fill the smoke box with Ninja Woodfire Pellets to the top. **DO NOT** overflow the smoke box.
- 5 Make sure the grill is plugged in and press the MODE button or use the dial to select the GRILL function.
- 6  If adding Ninja Woodfire Flavor, press the **WOODFIRE FLAVOR** button.
- 7 The default temperature setting will display. To adjust temperature, if desired, press TEMP and use the dial to increase or decrease temperature. Press dial to confirm, otherwise temperature will lock in after 5 seconds.
- 8 To adjust cook time, press TIME and use the dial to increase or decrease cook time. Press dial to confirm, otherwise cook time will lock in after 5 seconds.
- 9 Press START/STOP to begin preheating. If using Ninja Woodfire Flavor, the pellets will go through an ignition cycle (IGN), then the grill will begin preheating (PRE).

**NOTE:** While preheating is strongly recommended for best results, you can skip it by pressing and holding the START/STOP button for 4 seconds. ADD FOOD will flash across the screen. Open the hood and place ingredients on the grill grate. Once the hood is closed, cooking will begin and the timer will start counting down. Skip to step 12.

- 10 When preheating is complete, the grill will beep and ADD FOOD will appear on the display.
- 11 Open the hood and place ingredients on the grill grate. Once the hood is closed, cooking will begin and the timer will begin counting down.

**NOTE:** Want to cook with the hood open? After you've added food, keep the lid open, the timer will begin to count down after 30 seconds, and you will be cooking with bottom heat only.

- 12 When cook time reaches zero, the grill will beep and DONE will appear on the display.
- 13 Remove food from the grill grate.



### Smoker

- 1 Place grill on a flat, level surface.
- 2 Open the hood and install the grill grate by positioning it flat on top of the heating element so it sits in place.

**NOTE:** If you are using the thermometer, refer to the Using the Built-In Thermometer(s) section.

- 3 Install the grease tray by sliding it into place at the back of the grill.
- 4 Pull the smoke box open and use the pellet scoop to fill the smoke box with Ninja Woodfire Pellets to the top. **DO NOT** overflow the smoke box.
- 5 Open the hood and place ingredients on the grill grate. Close the hood.
- 6 Make sure the grill is plugged in and press the MODE button or use the dial to select the SMOKER function.

**NOTE:** Ninja Woodfire Flavor is automatically enabled when using the Smoker function.



- 7 The default temperature setting will display. To adjust temperature, if desired, press TEMP and use the dial to increase or decrease temperature. Press dial to confirm, otherwise temperature will lock in after 5 seconds.
- 8 To adjust cook time, press TIME and use the dial to increase or decrease cook time. Press dial to confirm, otherwise cook time will lock after 5 seconds.
- 9 Press START/STOP to begin cooking. There is no preheat time for the Smoker function. The pellets will go through an ignition cycle (IGN) for 5-7 minutes, then the grill will begin cooking and the timer will begin to count down.
- 10 When cook time reaches zero, the grill will beep and DONE will appear on the display.
- 11 Remove food from the grill grate.

**IMPORTANT:** Review all warnings at the beginning of this Owner's Guide before proceeding.

### Air Crisp

- 1 Place grill on a flat, level surface.
- 2 Open the hood and install the grill grate by positioning it flat on top of the heating element so it sits in place.
- 3 Place the crisper basket on the grill grate, positioning the basket feet in the designated indentations.

**NOTE:** If you are using the thermometer, refer to the Using the Built-in Thermometer section.

- 4 Install the grease tray by sliding it into place at the back of the grill.
- 5  If you plan to add Ninja Woodfire™ Flavor, pull the smoke box open and use the pellet scoop to fill the smoke box with Ninja Woodfire Pellets to the top. **DO NOT** overflow the smoke box.
- 6 Make sure the grill is plugged in and press the MODE button or use the dial to select the AIR CRISP function.
- 7  If adding Ninja Woodfire Flavor, press the **WOODFIRE FLAVOR** button.
- 8 The default temperature setting will display. To adjust temperature, if desired, press TEMP and use the dial to increase or decrease temperature. Press dial to confirm, otherwise temperature will lock in after 5 seconds.
- 9 To adjust cook time, press TIME and use the dial to increase or decrease cook time. Press dial to confirm, otherwise cook time will lock in after 5 seconds.
- 10 Press START/STOP to begin preheating. If using Ninja Woodfire Flavor, the pellets will go through an ignition cycle (IGN), then the grill will begin preheating (PRE).



**NOTE:** While preheating is strongly recommended for best results, you can skip it by pressing and holding the START/STOP button for 4 seconds. ADD FOOD will flash across the screen. Open the hood and place ingredients in the crisper basket. Once the hood is closed, cooking will begin and the timer will start counting down. Skip to step 13.

- 11 When preheating is complete, the grill will beep and ADD FOOD will appear on the display.
- 12 Open the hood and place ingredients on the grill grate. Once the hood is closed, cooking will begin and the timer will begin counting down.
- 13 When cook time reaches zero, the grill will beep and DONE will appear on the display.
- 14 Remove food from the crisper basket.

### Bake

- 1 Place grill on a flat, level surface.
- 2 Open the hood and install the grill grate by positioning it flat on top of the heating element so it sits in place.
- 3 Install the grease tray by sliding it into place at the back of the grill.

**NOTE:** If you are using the thermometer, refer to the Using the Built-In Thermometer(s) section.

- 4  If you plan to add Ninja Woodfire Flavor, pull the smoke box open and use the pellet scoop to fill the smoke box with Ninja Woodfire Pellets to the top. **DO NOT** overflow the smoke box.
- 5 Make sure the grill is plugged in and press the MODE button or use the dial to select the BAKE function.
- 6  If adding Ninja Woodfire Flavor, press the **WOODFIRE FLAVOR** button.
- 7 The default temperature setting will display. To adjust temperature, if desired, press TEMP and use the dial to increase or decrease temperature. Press dial to confirm, otherwise temperature will lock after 5 seconds.
- 8 To adjust cook time, press TIME and use the dial to increase or decrease cook time. Press dial to confirm, otherwise cook time will lock in after 5 seconds.
- 9 Press START/STOP to begin preheating. If using Ninja Woodfire Flavor, the pellets will go through an ignition cycle (IGN), then the grill will begin preheating (PRE).

**NOTE:** While preheating is strongly recommended for best results, you can skip it by pressing and holding the START/STOP button for 4 seconds. ADD FOOD will flash across the screen. Open the hood and place ingredients in the crisper basket. Once the hood is closed, cooking will begin and the timer will start counting down. Skip to step 12.

- 10 When preheating is complete, the grill will beep and ADD FOOD will appear on the display.
- 11 Open the hood and place ingredients on the grate or place bake pan on the grate. Once the hood is closed, cooking will begin and the timer will start counting down.
- 12 When cook time reaches zero, the grill will beep and DONE will appear on the display.
- 13 Remove food from the grill grate.

**NOTE:** When using the Bake function, make sure to use the proper accessory. For wet or battered ingredients, use a baking dish. For loose items, such as cinnamon rolls, hand pies, or biscuits, use the crisper basket.



## COOKING FUNCTIONS - CONT'D

**IMPORTANT:** Review all warnings at the beginning of this Owner's Guide before proceeding.

### Roast

- 1 Place grill on a flat, level surface.
- 2 Open the hood and install grill grate by positioning it flat on top of the heating element so it sits in place.

**NOTE:** If you are using the thermometer, refer to the Using the built-in Thermometer section.

- 3 Install the grease tray by sliding it into place at the back of the grill.
- 4  If you plan to add Ninja Woodfire™ Flavor, pull the smoke box open and use the pellet scoop to fill the smoke box with Ninja Woodfire Pellets to the top. **DO NOT** overflow the smoke box.
- 5 Make sure the grill is plugged in and press the MODE button or use the dial to select the ROAST function.
- 6  If adding Ninja Woodfire Flavor, press the **WOODFIRE FLAVOR** button.
- 7 The default temperature setting will display. To adjust temperature, if desired, press TEMP and use the dial to increase or decrease temperature. Press dial to confirm, otherwise temperature will lock after 5 seconds.
- 8 To adjust cook time, press TIME and use the dial to increase or decrease cook time. Press dial to confirm, otherwise cook time will lock in after 5 seconds.
- 9 Press START/STOP to begin preheating. If using Ninja Woodfire Flavor, the pellets will go through an ignition cycle (IGN), then the grill will begin preheating (PRE).

**NOTE:** While preheating is strongly recommended for best results, you can skip it by pressing and holding the START/STOP button for 4 seconds. ADD FOOD will flash across the screen. Open the hood and place ingredients in the crisper basket. Once the hood is closed, cooking will begin and the timer will start counting down. Skip to step 12.

- 10 When preheating is complete, the grill will beep and ADD FOOD will appear on the display.
- 11 Open the hood and place ingredients on the grill grate. Once the hood is closed, cooking will begin and the timer will begin counting down.
- 12 When cook time reaches zero, the grill will beep and DONE will appear on the display.
- 13 Remove food from grill grate.

### Broil

**NOTE:** Ninja Woodfire Flavor cannot be used with the Broil function.



- 1 Place grill on a flat, level surface.
- 2 Open the hood and install grill grate by positioning it flat on top of the heating element so it sits in place.

**NOTE:** If you are using the thermometer, refer to the Using the built-in Thermometer section.

- 3 Install the grease tray by sliding it into place at the back of the grill.
- 4 Open the hood and place ingredients on the grill grate. Close the hood. There is no preheat.
- 5 Make sure the grill is plugged in and press the MODE button or use the dial to select the BROIL function.
- 6 The default temperature setting will display. To adjust temperature, if desired, press TEMP and use the dial to increase or decrease temperature. Press dial to confirm, otherwise temperature will lock in after 5 seconds.
- 7 To adjust cook time, press TIME and use the dial to increase or decrease cook time. Press dial to confirm, otherwise cook time will lock in after 5 seconds.
- 8 Press START/STOP to begin cooking.
- 9 When cook time reaches zero, the grill will beep and DONE will appear on the display.
- 10 Remove food from the grill grate.

**IMPORTANT:** Review all warnings at the beginning of this Owner's Guide before proceeding.

### Dehydrate

- 1 Place grill on a flat, level surface.
- 2 Open the hood and install grill grate by positioning it flat on top of the heating element so it sits in place.
- 3 Install the grease tray by sliding it into place at the back of the grill.
- 4 Open the hood and place ingredients on the grill grate. Close the hood.
- 5  If you plan to add Ninja Woodfire™ Flavor, pull the smoke box open and use the pellet scoop to fill the smoke box with Ninja Woodfire Pellets to the top. **DO NOT** overflow the smoke box.
- 6 Make sure the unit is plugged in and rotate the dial clockwise from the OFF position to select the DEHYDRATE function.
- 7  If adding Ninja Woodfire Flavor, press the **WOODFIRE FLAVOR** button.
- 8 The default temperature setting will display. To adjust temperature, if desired, press TEMP and dial to increase or decrease temperature. Press dial to confirm, otherwise temperature will lock in after 5 seconds.
- 9 To adjust cook time, press TIME and use the dial to increase or decrease cook time. Press dial to confirm, otherwise cook time will lock after 5 seconds.
- 10 Press START/STOP to begin cooking. There is no preheat time for the Dehydrate function. If you are using Ninja Woodfire Flavor, the pellets will go through an ignition cycle (IGN) for 5-7 minutes, then the grill will begin cooking and the timer will begin to count down.
- 11 When cook time reaches zero, the grill will beep and DONE will appear on the display.
- 12 Remove food from the grill grate.

## GETTING TO KNOW THE NINJA WOODFIRE™ PRO XL OUTDOOR GRILL & SMOKER WITH BUILT-IN THERMOMETER

The grill should be cleaned thoroughly after each use. **ALWAYS** let the appliance and accessories cool before cleaning.

- Unplug the grill from power source before cleaning. Keep the hood open after removing your food to allow the unit to cool quicker.
- Remove smoke box and safely discard all contents after every use.
- The pellet scoop is dishwasher safe. The grill grate, crisper basket, grease tray, and smoke box are not dishwasher safe. **DO NOT** place the thermometer in the dishwasher.
- The Built-In Thermometer and holder are hand-wash only. **DO NOT** immerse any part of the thermometer in water or any other liquid. We recommend cleaning with a damp cloth only.
- Carefully remove cooled grease tray from back of unit and safely discard grease contents after each use. Hand-wash grease tray in warm, soapy water.
- It is not required to clean the smoke box after every use. We recommend using a wire brush to remove extra creosote after every 10 uses.

**NOTE: DO NOT** use liquid cleaning solution on the smoke box.

- The inner hood should be wiped down with a damp towel or cloth after each use to deodorize the unit and remove any grease.
- If food residue or grease is stuck on the grill grate or any other removable part, soak in warm, soapy water before cleaning.
- Remove non-stick grill grate and non-stick crisper basket (if used) after each use and hand-wash with warm, soapy water.
- Gently wipe down the inside of the hood with a damp cloth.
- When stacking the coated accessories to store, place a cloth or paper towel between each piece to protect the coated surfaces.

**NOTE: NEVER** use abrasive tools or cleaners. **NEVER** immerse the main unit in water or any other liquid. **DO NOT** place in dishwasher.

## REPLACEMENT PARTS

To order additional parts and accessories, visit [ninjaaccessories.com](http://ninjaaccessories.com) or contact Customer Service at 1-855-427-5125. We ask that you register your product online at [registeryourninja.com](http://registeryourninja.com) and have the product on hand when you call, so we may better assist you.

## TROUBLESHOOTING GUIDE

**⚠ WARNING: To reduce the risk of shock and unintended operation, turn power off and unplug unit before troubleshooting.**

- **“Add Food” appears on the control panel display.**  
The grill has completed preheating and it is now time to add your ingredients.
- **“Shut Lid” appears on the control panel display.**  
The hood is open and needs to be closed for the selected function to start.
- **“Add Grill” appears on the control panel.**  
The grill plate needs to be installed. Once installed, close the hood and press the START/STOP button to begin.
- **What does OTA mean?**  
An update is being sent to the grill. Do not unplug during this process. Wait for OTA to finish before use.
- **“E” appears on the control panel display.**  
The grill is not functioning properly. Contact Customer Service at 1-855-427-5125. So we may better assist you, please register your product online at [registeryourninja.com](http://registeryourninja.com) and have the product on hand when you call.
- **“CLD” appears on the control panel display.**  
Cold Smoking is to be used to provide smoke flavor to foods and is not intended for cooking. When used on meat, poultry, or fish, this process should always be used in conjunction with a separate step to bring food up to food-safe internal temperatures. Reference USDA guidelines for food-safe temperature recommendations.
- **Should I add my ingredients before or after preheating?**  
For best results, let the grill preheat before adding ingredients.
- **Why did a circuit breaker trip while using the unit?**  
The unit uses 1760 watts of power, so it must be plugged into an outlet on a 15-amp circuit breaker. Using an outlet on a 10-amp breaker will cause the breaker to trip. It is also important that the unit be the only appliance plugged into an outlet when in use. To avoid tripping a breaker, make sure the unit is the only appliance plugged into an outlet on a 15-amp breaker.
- **Do I need to completely fill the smoke box with pellets?**  
Yes, always fill the smoke box to the top. We've perfected the amount of pellets needed for each smoke session. Regardless of the function or food load, the grill will burn through them appropriately.
- **“Plug In” appears on the control panel display.**  
The thermometer is not plugged into the jack on the right side of the control panel. Plug the thermometer in before proceeding. Press the thermometer in until you hear a click.
- **Why does the unit have a 1-9 scale for the Beef Preset?**  
Perception of what a specific internal doneness looks like differs from person to person, even restaurant to restaurant. The 1-9 scale provides a wide range of options for each doneness level so you can customize doneness to your liking.
- **“PRBE ERR” appears on the control panel display.**  
This means the grill timed out before food reached the set internal temperature. As a protection for the unit, it can run for only certain lengths of time at specific temperatures.
- **Why is there a bend/dent on the inside of the lid?**  
This is not a bend in the metal; it is designed to properly drain grease from the inside of the unit while cooking.
- **Why is my food overcooked or undercooked even though I used the thermometer?**  
It is important to insert the thermometer lengthwise into the thickest part of the ingredient to get the most accurate reading. Make sure to allow food to rest for 3-5 minutes to complete cooking. For more information, refer to the Using the built-in Thermometer section.
- **When do I press the WOODFIRE FLAVOR Button?**  
Press the **WOODFIRE FLAVOR** button before pressing START/STOP in order to add authentic smoky flavors for the Grill, Air Crisp, Roast, Bake, or Dehydrate function. Ninja Woodfire™ Flavor is automatically enabled when using the Smoker function.
- **Where should I keep my pellets stored?**  
Always store pellets in a dry area. Any moisture in the pellets can compromise ignition and quality of smoke flavor.

## TROUBLESHOOTING GUIDE – CONT'D

- **Should I use any oils or nonstick sprays when smoking?**

No, we do not recommend using any oils or nonstick sprays when smoking because smoke will not adhere to the food as well.

- **How do I dispose of burnt pellets after a cook cycle?**

Pellets may continue to burn after cook time is complete. Do not touch or remove the smoke box until the grill has stopped smoking, pellets have completely burnt out, and the smoke box has cooled. At that point, remove the smoke box and safely discard cooled ash contents.

- **Why is preheat taking so long?**

Preheat times vary by function and unit temperature.

**GRILL: LOW:** 9-12 minutes **MED:** 10-13 minutes **HIGH:** 13-15 minutes

**AIR CRISP, BAKE, ROAST:** 2-3 minutes

**SMOKER, DEHYDRATE, BROIL:** No preheat.

If adding Ninja Woodfire™ Flavor, ignition time will add an additional 3-6 minutes.

Using the unit in inclement weather with heavy rain could cause longer preheat times.

Longer cord length may also cause longer preheat times. We recommend using the shortest outdoor rated extension cord that fits your outdoor grill setup. We recommend using only outdoor extension cords marked as "SJOW" and "suitable for use with outdoor appliances."

For cords up to 25 feet, use 14 gauge. For 25- to 50-foot cords, use 12 gauge. Cords longer than 50 feet are not recommended.

While preheating is strongly recommended for best results, you can skip it by pressing and holding the START/STOP button for 4 seconds. "ADD FOOD" will flash across the screen. Open the hood and place ingredients in unit. Once the hood is closed, cooking will begin and the timer will start counting down.

- **Can I turn off Ninja Woodfire Flavor?**

If you pressed **WOODFIRE FLAVOR** and already started your cooking function by pressing START/STOP, you can press the **WOODFIRE FLAVOR** button again to turn it off if the ignition cycle is less than 75% complete (indicated by the progress bar on the display screen). If pellets have fully ignited and the grill has transitioned to the preheat cycle (indicated on the display screen), you cannot turn off Ninja Woodfire Flavor Technology.

- **Can I add more pellets during a cook cycle?**

When using the Smoker function, you can add more pellets once the first batch has fully burned. Press and hold the **WOODFIRE FLAVOR** button for 3 seconds to ignite new full box of pellets.

To run back-to-back smoking sessions, we recommend refilling the smoke box using the pellet scoop when half the pellets have burned. **DO NOT** refill more than once or twice. **DO NOT** reignite pellets.

- **Wi-fi troubleshooting**

- Typical home Wi-Fi networks support both 2.4 GHz and 5 GHz.
- Do not use a VPN or a proxy server. Hotspot available to connect only at 2.4GHz.
- Make sure Wi-Fi isolation is turned off on the router.
- If you cannot connect, call **1- 855-427-5125**.

- **Still can't connect?**

- Restart your phone.
- Turn off your phone, wait a few minutes, then turn it back on and connect to Wi-Fi.
- Reboot your grill.
- Unplug your grill for 10 seconds, then plug it back in and press the power button.
- Reboot your router.
- Unplug the router power cable for 30 seconds, then plug it back in. Allow several minutes for your router to reboot completely.

- **What should I do if I verified a wireless network password that is incorrect?**

Close the app, then reopen it. Make sure to enter the correct Wi-Fi network password. In your phone's network settings, choose your home 2.4 GHz network, and select Forget. Reconnect to your home network. Make sure to use the correct password. (We recommend using the eye icon when entering your password to make sure it is correct.) If you were able to connect to your home network, proceed to the app setup process. Turn off your router and wait 30 seconds. Turn your router back on. Check to make sure your 2.4 GHz network is visible in your phone settings. Turn off the grill, then wait 10 seconds. Turn the grill back on. Hard-close the app and restart the connection process on the Grill. If you cannot locate your Wi-Fi password, please contact your Internet service provider.

## TROUBLESHOOTING GUIDE – CONT'D

- **What should I do if my username or password is invalid?**

We recommend you select the eye icon next to the password entry to verify you are entering your password correctly. Select the "Forgot Password" option on the sign-in page. The automated system will email you a link to reset your password. If you do not see an email, search your inbox and spam folder for emails from [mysharkninja@sharkninja.com](mailto:mysharkninja@sharkninja.com). You can use the "Resend Email" option to send the email again.

- **What should I do if there is an issue resetting password (did not receive the email or token was invalid)?**

Select the "Forgot Password" option on the sign-in page. The automated system will email you a link to reset your password. If you do not see an email, search your inbox and spam folder for emails from [mysharkninja@sharkninja.com](mailto:mysharkninja@sharkninja.com). You can use the "Resend Email" option to send the email again.

## NINJA COOKING CONNECTED GRILL

### IMPORTANT: PLEASE READ THE TERMS AND CONDITIONS OF THIS LICENSE AGREEMENT

SharkNinja Operating LLC's ("SharkNinja") End-User License Agreement ("EULA") is a legal agreement between You (either a single entity or an individual) and SharkNinja for SharkNinja's Software Applications, including those installed by You onto your SharkNinja products or already installed on your device, including all firmware (referred hereafter as "SN APPS"). By installing, copying, checking a box, clicking a button confirming your agreement to these terms, or otherwise continuing to use the SN APPS, You agree to be bound by the terms of this EULA. This license agreement represents the entire agreement concerning SN APPS between You and SharkNinja, and it supersedes any prior proposal, representation, or understanding between the parties. If You do not agree to the terms of this EULA, do not install or use the SN APPS or this product. The SN APPS are protected by copyright laws and international copyright treaties, as well as other intellectual property laws and treaties.

#### 1. GRANT OF LICENSE. The SN APPS are licensed as follows:

- 1.1** Installation and Use. SharkNinja grants You the right to download, install, and use SN APPS on the specified platform for which the SN APP was designed and in connection with SharkNinja products with which the SN APPS are designed to operate ("SN Devices").
- 1.2** Backup Copies. You may also make a copy of SN APPS downloaded and installed by You for backup and archival purposes.

#### 2. DESCRIPTION OF OTHER RIGHTS AND LIMITATIONS.

- 2.1** Maintenance of Copyright Notices. You must not remove or alter any copyright notices on any and all copies of the SN APPS.
- 2.2** Distribution. You may not distribute copies of the SN APPS to third parties.
- 2.3** Prohibition on Reverse Engineering, Decompilation, and Disassembly. You may not reverse engineer, decompile, or disassemble SN APPS, except and only to the extent that such activity is expressly permitted by applicable law notwithstanding this limitation.
- 2.4** Rental. You may not rent, lease, or lend SN APPS without written permission from SharkNinja.
- 2.5** NOT FOR RESALE SOFTWARE. Applications identified as "Not for Resale" or "NFR," may not be resold, transferred, or used for any purpose other than demonstration, test, or evaluation.
- 2.6** Support Services. SharkNinja may provide You with support services related to SN APPS ("Support Services"). Any supplemental software code provided to You as part of the Support Services shall be considered part of SN APPS and subject to the terms and conditions of this EULA.
- 2.7** Compliance with Applicable Laws. You must comply with all applicable laws regarding use of SN APPS.

#### 3. UPDATES.

SharkNinja may provide You with upgrades or updates to SN APPS. This EULA will govern any upgrades provided by SharkNinja that replace and/or supplement SN APPS, unless such upgrade is accompanied by a separate EULA, in which case the terms of that EULA will govern. If You decide not to download and use an upgrade or update provided by SharkNinja, You understand that You could put SN Apps at risk to serious security threats or cause SN Apps to become unusable or unstable.



# NINJA COOKING CONNECTED GRILL – CONT'D

## **IMPORTANT: PLEASE READ THE TERMS AND CONDITIONS OF THIS LICENSE AGREEMENT CAREFULLY BEFORE CONTINUING WITH THIS PROGRAM INSTALL OR USE OF THIS PRODUCT:**

### **4. DATA AND PRIVACY.**

SharkNinja is committed to ensuring your privacy by adhering to high standards of fairness and integrity. We are committed to keeping our customers informed about how we use the information we gather from You through the use of each of our websites or SN APPS. Our privacy practices are described in SharkNinja's Privacy Policy, as well as in separate notices given when an app, product, or service is purchased or downloaded. By using SN APPS or providing us with your personal information, You are accepting and consenting to the practices, terms, and conditions described in SharkNinja's Privacy Policy. At all times your information will be treated in accordance with the SharkNinja Privacy Policy, which is incorporated by reference into this EULA and can be viewed at the following URL: <http://www.sharkninja.com/privacypolicy>.

### **5. THIRD-PARTY APPLICATION LIBRARIES AND EMBEDDED SOFTWARE.**

- 5.1** You acknowledge that Ayla Networks, Inc. ("Ayla") has provided certain application libraries that have been embedded into SN APPS ("Ayla Application Libraries") and enables SN Devices to connect to the Ayla Cloud Service ("Ayla Embedded Software").
- 5.2** You will not use the Ayla Application Libraries except as an incorporated portion of SN APPS, unmodified from the form provided to You.
- 5.3** You will not use the Ayla Embedded Software except as an incorporated portion of SN Devices, unmodified from the form provided to You.
- 5.4** You will not modify, adapt, translate, or create derivative works based on, or decompile, disassemble, reverse engineer, or otherwise attempt to derive the source code or underlying algorithms of, the Ayla Application Libraries or the Ayla Embedded Software.
- 5.5** SharkNinja retains all ownership of SN APPS (and the Ayla Application Libraries contained therein) and any software installed on SN Devices (including the Ayla Embedded Software) and only a license thereto is granted to You for use in connection with the SN APPS and SN Devices.
- 5.6** You will not use the Ayla Application Libraries or Ayla Embedded Software to attempt to gain unauthorized access to or use of the systems/services of SharkNinja's other licensors; nor will You transmit viruses, worms, Trojan horses, time bombs, spyware, malware, cancelbots, passive collection mechanisms, robots, data mining software, or any other malicious or invasive code or program into the systems/services of SharkNinja's other licensors.
- 5.7** You will not use the Ayla Application Libraries or Ayla Embedded Software to interfere with, breach, or circumvent any security feature, authentication feature, or any other feature that restricts or enforces limitations on the use of, or access to, the systems/services of SharkNinja's other licensors.
- 5.8** You will not probe, attack, scan, or test the vulnerability of the systems/services of SharkNinja's other licensors.
- 5.9** SharkNinja's other licensors of the SN APPS, Ayla Application Libraries, and the Ayla Embedded Software are the express third-party beneficiaries of this EULA, and the provisions of this Section of this EULA are made expressly for the benefit of such licensors, and are enforceable by such licensors.

### **6. TERMINATION.**

Without prejudice to any other rights, SharkNinja may terminate this EULA if You fail to comply with the terms and conditions of this EULA. In such event, You must destroy all copies of SN APPS in your possession.

### **8. OPEN SOURCE SOFTWARE.**

You hereby acknowledge that SN APPS may contain software that is subject to "open source" or "free software" licenses ("Open Source Software"). The license granted by this EULA does not apply to Open Source Software contained in the SN APPS. Rather, the terms and conditions in the applicable Open Source Software license shall apply to the Open Source Software. Nothing in this EULA limits your rights under, or grants You rights that supersede, any Open Source Software license. You acknowledge that the Open Source Software license is solely between You and the applicable licensor of the Open Source Software. To the extent the terms of the licenses applicable to the Open Source Software require SharkNinja to provide the Open Source Software, in either source or executable form, or to provide copies of applicable license terms or other required information, You may obtain a copy of the software by contacting SharkNinja at the below physical address. Additional information about the Open Source Software, and its terms of use, may be found at [www.sharkclean.com/opensource](http://www.sharkclean.com/opensource).

### **9. NO WARRANTIES.**

SharkNinja expressly disclaims any warranty for SN APPS, Ayla Application Libraries, or Ayla Embedded Software. SN APPS, Ayla Application Libraries, and Ayla Embedded Software are provided 'As Is' without any express or implied warranty of any kind, including but not limited to any warranties of merchantability, noninfringement, fitness of a particular purpose, or title. SharkNinja does not warrant or assume responsibility for the accuracy or completeness of any information, text, graphics, links, or other items contained within the SN APPS. SharkNinja makes no warranties respecting any harm that may be caused by the transmission of a computer virus, worm, logic bomb, or other such computer program. SharkNinja further expressly disclaims any warranty or representation to any third party.

### **10. LIMITATION OF LIABILITY.**

In no event shall SharkNinja or its suppliers be liable for any special, incidental, punitive, indirect, or consequential damages whatsoever (including, but not limited to, damages for loss of profits or confidential or other information, for business interruption, for personal injury, for loss of privacy, for failure to meet any duty including of good faith or of reasonable care, for negligence, and for any other pecuniary or other loss whatsoever) arising out of or in any way related to the use of or inability to use SN Devices or SN APPS, the provision of or failure to provide support or other services, information, software, and related content through the product or otherwise arising out of the use of SN APPS, or otherwise under or in connection with any provision of this EULA, even in the event of the fault, tort (including negligence), strict liability, breach of contract, or breach of warranty of SharkNinja or any supplier, and even if SharkNinja or any supplier has been advised of the possibility of such damages. SharkNinja shall have no liability with respect to the content of the SN APPS or any part thereof, including but not limited to errors or omissions contained therein, libel, infringements of rights of publicity, privacy, trademark rights, business interruption, personal injury, loss of privacy, moral rights, or the disclosure of confidential information.

### **11. APPLICABLE LAW.**

The laws of the Commonwealth of Massachusetts will govern this EULA and You hereby consent to exclusive jurisdiction and venue in the state and federal courts sitting in the Commonwealth of Massachusetts.

### **12. ASSIGNMENT.**

SharkNinja may assign this EULA without notice to Licensor.

### **13. ENTIRE AGREEMENT.**

This EULA (including any addendum or amendment to this EULA which is included with the SN Devices) is the entire agreement between You and SharkNinja relating to the SN APPS and supersedes all prior or contemporaneous oral or written communications, proposals and representations with respect to the SN APPS or any other subject matter covered by this EULA. To the extent the terms of any SharkNinja policies or programs for support services conflict with the terms of this EULA, the terms of this EULA shall control. If You have questions regarding this EULA, please contact SharkNinja at 89 A Street, Suite 100, Needham, MA 02494.

## ONE (1) YEAR LIMITED WARRANTY

NJA\_1\_YR\_IB\_LMTD\_WRTY\_US\_ENG\_OUTDOOR

The One (1) Year Limited Warranty applies to purchases made from authorized retailers of **SharkNinja Operating LLC**. Warranty coverage applies to the original owner and to the original product only and is not transferable.

SharkNinja warrants that the unit shall be free from defects in material and workmanship for a period of one (1) year from the date of purchase when it is used under normal household conditions and maintained according to the requirements outlined in the Owner's Guide, subject to the following conditions and exclusions:

### What is covered by this warranty?

1. The original unit and/or non-wearable parts deemed defective, in SharkNinja's sole discretion, will be repaired or replaced up to one (1) year from the original purchase date.
2. In the event a replacement unit is issued, the warranty coverage ends six (6) months following the receipt date of the replacement unit or the remainder of the existing warranty, whichever is later. SharkNinja reserves the right to replace the unit with one of equal or greater value.

### What is not covered by this warranty?

1. Normal wear and tear of wearable parts (such as blending vessels, lids, cups, blades, blender bases, removable pots, racks, pans, etc.), which require regular maintenance and/or replacement to ensure the proper functioning of your unit, are not covered by this warranty. Replacement parts are available for purchase at [ninjaaccessories.com](http://ninjaaccessories.com).
2. Any unit that has been tampered with or used for commercial purposes.
3. Damage caused by misuse, abuse, negligent handling, failure to perform required maintenance (e.g., failure to keep the well of the motor base clear of food spills and other debris), or damage due to mishandling in transit.
4. Consequential and incidental damages.
5. Defects caused by repair persons not authorized by SharkNinja. These defects include damages caused in the process of shipping, altering, or repairing the SharkNinja product (or any of its parts) when the repair is performed by a repair person not authorized by SharkNinja.
6. Products purchased, used, or operated outside North America.

### How to get service

If your appliance fails to operate properly while in use under normal household conditions within the warranty period, visit [ninjakitchen.com/support](http://ninjakitchen.com/support) for product care and maintenance self-help. Our Customer Service Specialists are also available at **1-855-427-5125** to assist with product support and warranty service options, including the possibility of upgrading to our VIP warranty service options for select product categories. So we may better assist you, please register your product online at [registeryourninja.com](http://registeryourninja.com) and have the product on hand when you call.

SharkNinja will cover the cost for the customer to send in the unit to us for repair or replacement. A fee of \$20.95 (subject to change) will be charged when SharkNinja ships the repaired or replacement unit.

### How to initiate a warranty claim

You must call **1-855-427-5125** to initiate a warranty claim. You will need the receipt as proof of purchase. We also ask that you register your product online at [registeryourninja.com](http://registeryourninja.com) and have the product on hand when you call, so we may better assist you. A Customer Service Specialist will provide you with return and packing instruction information.

### How state law applies

This warranty gives you specific legal rights, and you also may have other rights that vary from state to state. Some states do not permit the exclusion or limitation of incidental or consequential damages, so the above may not apply to you.

---

---

---

---

---

---

---

---

---

---

---

---

---

---

---

---

---

---

---

---

---

---

---

---

---

---

---

---

---

---

# THANK YOU FOR PURCHASING THE NINJA WOODFIRE™ PRO XL OUTDOOR GRILL & SMOKER WITH BUILT-IN THERMOMETER



## REGISTER YOUR PURCHASE



registeryourninja.com



Scan QR code using mobile device

## TECHNICAL SPECIFICATIONS

Voltage: 120V~, 60Hz  
Power: 1760 Watts

## RECORD THIS INFORMATION

Model Number: \_\_\_\_\_

Serial Number: \_\_\_\_\_

Date of Purchase: \_\_\_\_\_  
(Keep receipt)

Store of Purchase: \_\_\_\_\_

## FCC WARNINGS

This equipment has been tested and found to comply with the limits for a Class B digital device, pursuant to parts 15 of the FCC Rules. These limits are designed to provide reasonable protection against harmful interference in a residential installation. This equipment generates, uses, and can radiate radio frequency energy and, if not installed and accordance with the instructions, may cause harmful interference to radio communications.

However, there is no guarantee that interference will not occur in a particular installation. If this equipment does cause harmful interference to radio or television reception, which can be determined by turning the equipment off and on, the user is encouraged to try to correct the interference by one or more of the following measures:

- Reorient or relocate the receiving antenna.
- Increase the separation between the equipment and receiver.
- Connect the equipment into an outlet on a circuit different from that to which the receiver is connected.
- Consult the dealer or an experienced radio/TV technician for help.

**This device complies with part 15 of the FCC rules. Operation is subject to the following conditions:**

1. This device may not cause harmful interference.
2. This device must accept any interference received, including interference that may cause undesired operation.

Changes or modifications not expressly approved by the party responsible for compliance could void the user's authority to operate this device.

## ISED STATEMENT

This device complies with Industry Canada license-exempt RSS standard(s). Operation is subject to the following two conditions: (1) this device may not cause interference, and (2) this device must accept any interference, including interference that may cause undesired operation of the device.

**SharkNinja Operating LLC**  
**US: Needham, MA 02494**  
**1-855-427-5125**  
**ninjakitchen.com**

Illustrations may differ from actual product. We are constantly striving to improve our products, therefore the specifications contained herein are subject to change without notice.

NINJA WOODFIRE is a trademark of SharkNinja Operating LLC.

This product may be covered by one or more U.S. patents. See [sharkninja.com/patents](http://sharkninja.com/patents) for more information.

