

NINJA®

Professional Blender

BL500

OWNER'S GUIDE



**RECIPE
IDEAS
INSIDE!**

Euro-Pro Operating LLC
US: Newton, MA 02459
CAN: Ville St-Laurent, QC H4S 1A7

1-800-798-7398

www.ninjakitchen.com

Copyright © 2011 Euro-Pro Operating LLC

Printed in China

Illustrations may differ from actual product.

BL500.E.110223.2

IMPORTANT SAFETY INSTRUCTIONS

For Household Use Only

WHEN USING ELECTRICAL APPLIANCES, BASIC SAFETY PRECAUTIONS SHOULD ALWAYS BE FOLLOWED, INCLUDING THE FOLLOWING:

READ ALL INSTRUCTIONS BEFORE USING YOUR NINJA® PROFESSIONAL BLENDER.

POLARIZED PLUG

WARNING: To reduce the risk of electric shock, this appliance has a polarized plug (one blade is wider than the other). This plug will fit into a polarized outlet only one way. If the plug does not fit fully into the outlet, reverse the plug. If it still does not fit, contact a qualified electrician to install the proper outlet. **DO NOT modify the plug in any way.**

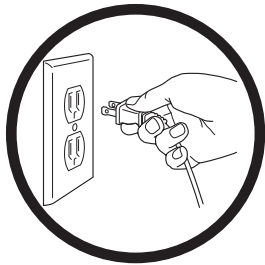

1. To protect against electrical shock, do not submerge the blender or allow the power cord to come into contact with water or any other liquid.
2. Close supervision is necessary when any appliance is used by or near children.
3. Never leave an appliance unattended when in use.
4. Turn the appliance Off and remove the power cord from the electrical outlet when not in use, before assembling or disassembling parts and before cleaning. To unplug, grasp the plug and pull from the electrical outlet. Never pull from the power cord.
5. **DO NOT** abuse the power cord. Never carry the appliance by the power cord or yank it to disconnect from electrical outlet; instead grasp the plug and pull to disconnect.
6. **DO NOT** operate any appliance with a damaged cord or plug, or after the appliance malfunctions, has been dropped or damaged in any manner. Return the appliance to EURO-PRO Operating LLC for examination, repair or adjustment.
7. **DO NOT** let the power cord hang over the edge of table or counter or touch hot surfaces such as the stove.
8. Always use appliance on a dry, level surface.
9. Keep hands, hair, clothing, as well as utensils out of container while blending to reduce the risk of severe injury to persons or damage to the appliance. A scraper may be used but only when the blender is not running.
10. **CAUTION:** Blade assembly is sharp, handle with care. When handling the blade assembly, always hold by the shaft.
11. Avoid contact with moving parts.
12. **DO NOT attempt to sharpen blades.**
13. **DO NOT** use the appliance if blade assembly is bent or damaged.
14. To reduce risk of injury, never place the blade assembly on base without pitcher properly attached.
15. **DO NOT** operate this appliance on or near any hot surfaces (such as gas or electric burner or in a heated oven).
16. The use of attachments or accessories including canning jars, not recommended by the manufacturer may result in fire, electric shock or personal injury.
17. **DO NOT** remove the pitcher from the motor base while the blender is in operation.
18. To reduce the risk of injury, **NEVER** operate the appliance without the lid in place; **DO NOT** try to defeat the interlock mechanism; make sure that the cutting blades are properly installed before operating the appliance.
19. **DO NOT** expose pitcher to extreme temperature changes.
20. Exercise extreme caution when blending hot liquids.
21. **CAUTION:** Do not process food or liquid that is hotter than 180°F/82°C. Allow very hot ingredients to cool before processing.
22. **DO NOT** overfill.
23. Extreme caution must be used when moving an appliance containing hot food, water or other liquids.
24. When processing hot foods or liquids, always open the pouring spout cap to vent the steam. Keep hands and other exposed skin away from the opening to prevent possible burns or scalding.
25. **DO NOT** operate the appliance empty.

26. Always allow the appliance to cool after blending hot liquids before taking off parts and before cleaning.
27. If the appliance overheats, a thermal switch will become activated and shut off the motor. To reset, unplug the appliance and let it cool down for approximately 15 minutes before using again.

28. **THIS PRODUCT IS INTENDED FOR HOUSEHOLD USE ONLY.** Do not use this appliance for anything other than its intended use. Do not use outdoors.

NOTE: This unit has a short power supply cord to reduce the risk resulting from becoming entangled in or tripping over a long cord. An extension cord may be used if you are careful in its use.

1. If using an extension cord, the electrical rating of the extension cord should be rated at least 15 amperes. Extension cords rated for less amperage may overheat.
2. An extension cord must be arranged so that it will not drape over the countertop or tabletop where it can be pulled on by children or tripped over accidentally.

SAVE THESE INSTRUCTIONS



Contents

Thank you for
purchasing
the Ninja®
Professional
Blender.

| | |
|---|----|
| Getting Started | 6 |
| Using the Ninja® Professional Blender | 8 |
| Care & Maintenance | 11 |
| Troubleshooting Guide | 11 |
| Replacement Parts | 11 |
| Recipes..... | 12 |
| Warranty and Registration | 15 |

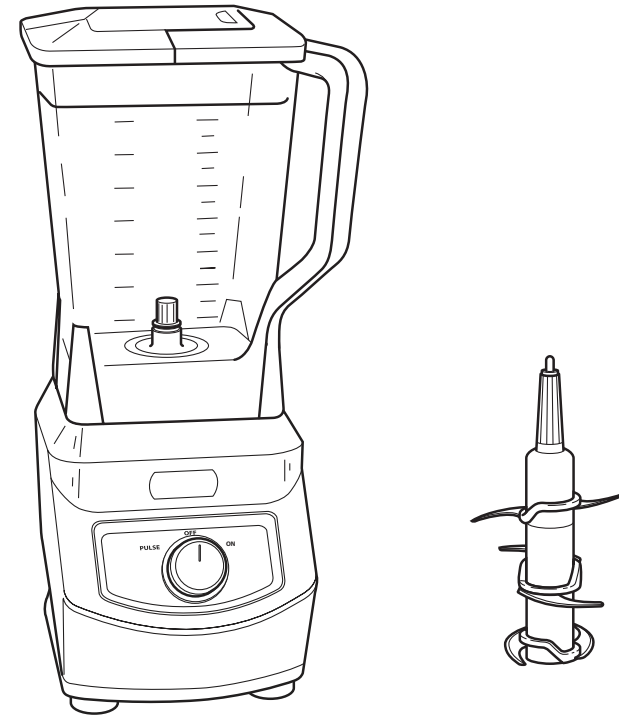

THIS BOOK COVERS MODEL NUMBER:

BL500 30

TECHNICAL SPECIFICATIONS

Voltage: 120V., 60Hz.

Power: 900 Watts

Pitcher Capacity: 72 ounces (9 cups) (2.15 L)



Getting Started

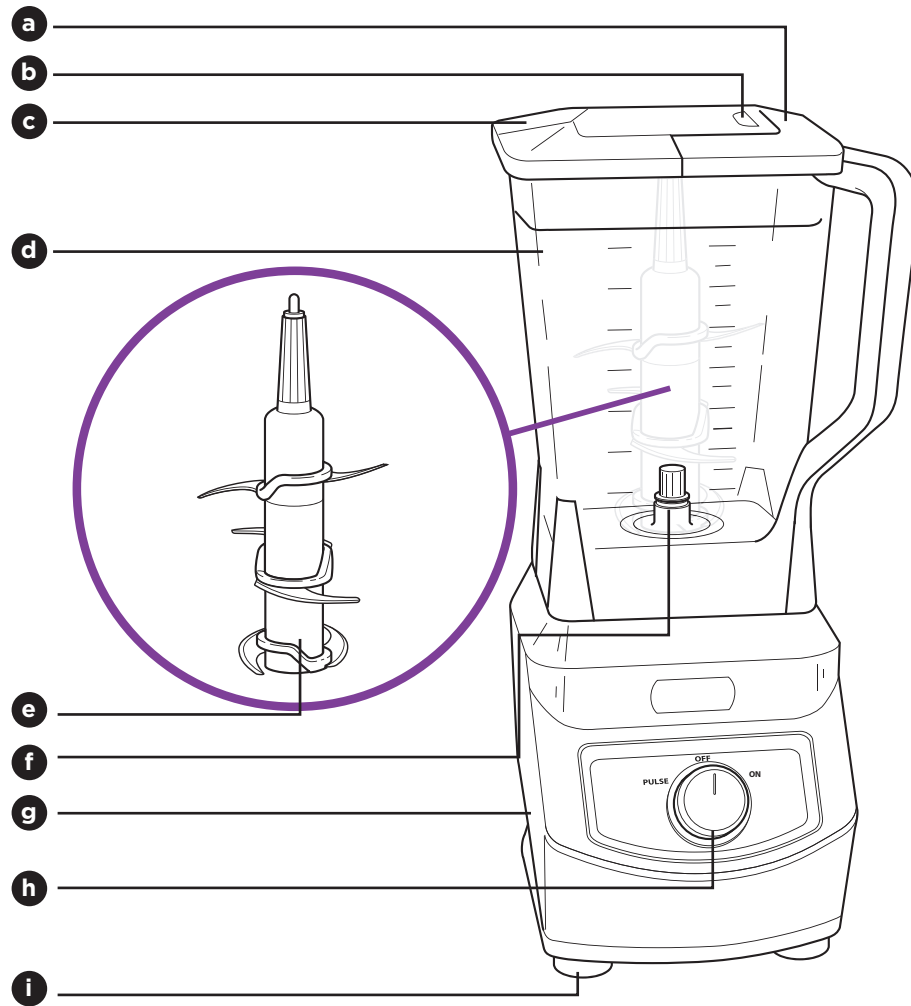

- a** Lid with Locking Handle
- b** Locking Handle Release Button
- c** Pouring Spout with Cap
- d** Pitcher (72 oz.)
- e** Ninja™ 6-Blade
- f** Gear Shaft

- g** Motor Base
- h** Control Panel
- i** Non Slip Bottom
- j** Power Cord (not shown)
- k** Cord Storage (in back) (not shown)

The Ninja® Professional Blender is a high powered kitchen tool that is perfect for ice crushing, blending, pureeing and controlled processing. Create all of your favorite recipes fast and easy with just a turn of the knob. For best results, be sure to carefully read all the instructions contained in the manual before using this appliance.



FEATURES:

- **Ninja® Blade technology**
- **Easy lock lid with built-in pour spout**
- **Extra Large 72 oz. pitcher - BPA free**
- **Cord storage**
- **Sturdy, Non-Slip Base**
- **Hidden Drain Holes - prevent water build up from dishwasher**



Using the Ninja® Professional Blender

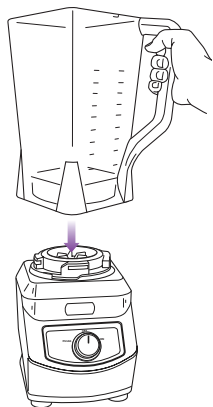

Fig. 1

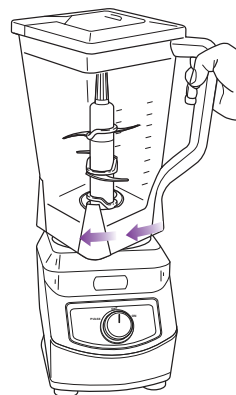

Fig. 2

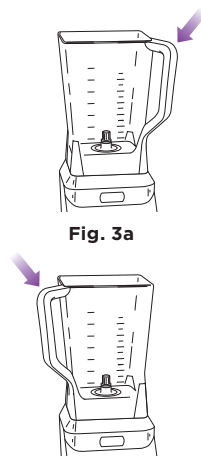

Fig. 3a

Fig. 3b

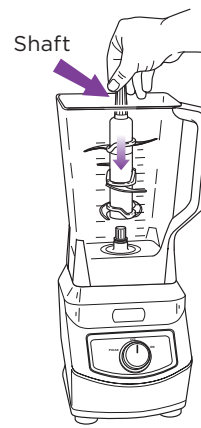

Fig. 4

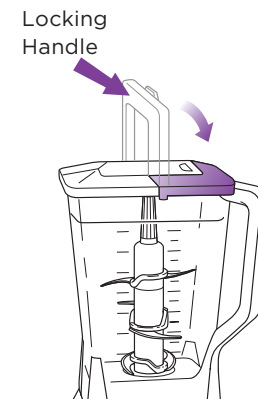

Fig. 5

BEFORE FIRST USE

- 1 Remove all packaging material and labels from the appliance.
- 2 Wash the lid, pitcher and blade assembly in warm, soapy water with a soft cloth. **Use caution when washing the blade assembly as the blades are very sharp.**
- 3 Rinse and dry thoroughly.
- 4 The pitcher, lid and blade assembly are all dishwasher safe. It is recommended that the lid and blade assembly go on the top rack. Ensure that the blade assembly is removed from the pitcher before placing in the dishwasher.
- 5 The motor base can be wiped clean with a damp cloth.

HOW TO ASSEMBLE

- ⚠ CAUTION:** Make sure that the motor base is unplugged from the power source.
- 1 Place the motor base on a clean, dry, level surface.
 - 2 Lower the pitcher onto the motor base. (Fig. 1)
 - 3 Rotate the pitcher to the left as far as it will go. As the pitcher rotates, it will lower and the safety tabs on the bottom of the pitcher will slide under the safety tabs on the top of the motor base. (Fig. 2)
 - 4 The pitcher can be placed on the motor base two ways; the handle can be on the front right corner or the front left corner. (Fig. 3a, Fig. 3b)
 - 5 Holding the blade assembly by the shaft, place it onto the gear shaft inside the pitcher. (Fig. 4) Ensure that the blade assembly fits around the gear shaft and that the blade shaft is standing straight.
- ⚠ CAUTION:** Blades are sharp! Use extreme caution when handling the blades. Always hold them by the shaft.

HOW TO USE

- 1 Place pitcher on motor base and insert the blade assembly. (See HOW TO ASSEMBLE.)
 - 2 Add the ingredients to the pitcher. Make sure your total of ingredients don't exceed the highest measured marking line on the side of the pitcher.
- ⚠ IMPORTANT:** Never add ingredients into the pitcher before placing the blades in first.
- 3 Place the lid onto the pitcher with the locking handle in the upright position and the pouring spout on the corner opposite the pitcher handle. Align the arrows (▼) located on the lid and pitcher handle. Ensure that the lid is completely seated and press the lid down into the pitcher. Press the locking handle down so that the latches on the lid fit under the tabs on the pitcher. (Fig. 5)
 - 4 Plug the power cord into the electrical outlet.

NOTE: As a safety feature, the motor will not work if the pitcher and lid are not installed correctly. When the pitcher and lid are installed properly, the ready light will be solid green, indicating that the blender is ready for use.

- 5 Use the control panel according to your blending requirements:
 - Turn the knob to the "ON" position to continually process the ingredients to a smooth mixture.
 - Turn the knob to the "PULSE" position for controlled processing.
 - Turn the knob to the "OFF" position once you are finished processing.

NOTE: If you need to add additional ingredients while the blender is processing, open the pouring spout cap and pour the ingredients in through the opening.

Using the Ninja® Professional Blender - cont'd

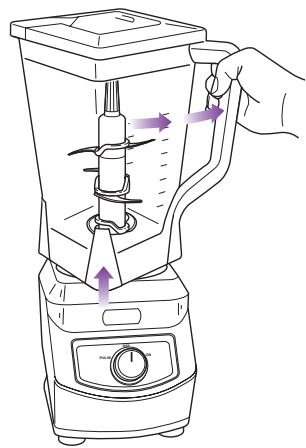

Fig. 6

- 6 When you have reached your desired consistency, stop the appliance by turning the knob to the “OFF” position and wait for the blades to stop turning.

Depending on the consistency of the contents, remove the pitcher (**Fig. 6**) and then open the pouring spout cap to empty the liquid contents.

For thicker consistencies, remove the lid by pressing the release button, lifting the handle up and pulling the lid straight up. (**Fig. 7**) Remove the blade assembly carefully (by its shaft) and then empty the contents of the pitcher.

CAUTION: Always use a spatula to dislodge food that has stuck to the sides of the pitcher. Never insert your hands into the pitcher as the blades are sharp.

CAUTION: Never remove the pitcher while the blender is still running.

- 7 Unplug the appliance after use.

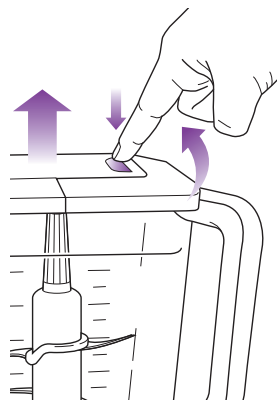

Fig. 7

IMPORTANT: Never run the appliance empty.

CAUTION: Use extreme caution when processing hot foods or liquids to avoid accidental scalding or burns. Do not process food or liquid that is hotter than 180°F/82°C. Allow very hot ingredients to cool before processing.

When processing hot foods or liquids, always open the pouring spout cap to vent the steam. Keep hands and other exposed skin away from the opening to prevent possible burns or scalding.

WARNING: Secure the blender while in use by pressing down on the lid with one hand.

WARNING: Never leave the blender unattended while in use.

Care & Maintenance

HOW TO CLEAN

- CAUTION:** Make sure that the motor base is unplugged from the power source before inserting or removing any attachment and before cleaning.
- CAUTION:** DO NOT immerse the motor base into water or any other liquid. Clean with a damp sponge or cloth and wipe dry.

- The pitcher, lid and blade assembly are all dishwasher safe. It is recommended that the lid and blade assembly be placed on the top rack.
- You may also wash the blender by filling $\frac{3}{4}$ of the pitcher with warm water and a drop of dish washing detergent, placing the lid on the pitcher and pressing the pulse button a few times. Once clean,

remove the pitcher from the motor base. Rinse the pitcher, blade assembly and lid under running water. Allow all the parts to dry before storing.

Use extreme caution when handling the blade assembly as blades are very sharp.

Please call customer service if any servicing needs to be performed on the appliance at 1-800-798-7398.

HOW TO STORE

- Store the Ninja® Professional Blender upright with the pitcher, blade assembly and cover on the motor base. Do not place anything on top.
- Tuck power cord in cord storage compartment in the back of the unit.

Troubleshooting Guide

| PROBLEMS | POSSIBLE REASONS & SOLUTIONS |
|--|---|
| Motor Doesn't Start or Blades Don't Rotate. | <p>Make sure the pitcher is securely placed on motor base.</p> <p>Make sure the lid is securely on pitcher in the correct position (align arrows).</p> <p>The blender is turned Off. Turn the knob to “PULSE” or “ON”.</p> <p>Check that the plug is securely inserted into the electrical outlet.</p> <p>Check the fuse or circuit breaker.</p> <p>The unit has overheated. Unplug and wait approximately 15 minutes before using again.</p> <p>Make sure that the ready light is a solid green and that the appliance is assembled correctly.</p> |
| You Cannot Achieve Snow From Solid Ice. | <p>Do not use ice that has been sitting out or has started to melt. Use ice straight from the freezer.</p> |

Replacement Parts

To order additional parts and accessories, please visit our website: www.ninjakitchen.com or feel free to contact customer service: 1-800-798-7398.

Recipes

Sparkling Raspberry Lemon Spritzer

Ingredients:

| | |
|---------|--|
| 1 Pint | Raspberries (Fresh or Frozen and Thawed) |
| 1 Cup | Lemonade |
| 3 Tbsp. | Honey |
| 8 Cups | Sparkling Water |
| 4 | Mint Leaves |

Directions:

Place the raspberries, lemonade and honey in the pitcher and blend for one minute. Pour the juice blend into 4 tall glasses. Top with sparkling water and stir well to combine. Add ice cubes and mint leaves for garnish. Serves 4

Mocha Freeze

Ingredients:

| | |
|---------|---------------------------------|
| 1/3 Cup | Instant Cocoa Mix |
| 2 Tbsp. | Instant Coffee |
| 1/4 Cup | Sugar |
| 1/4 Cup | Hot Water |
| 1 Quart | Low Fat Milk (Partially Frozen) |

Directions:

In a small bowl, mix together the cocoa mix, coffee and sugar. Add the hot water and stir to blend well. Pour the mixture into the pitcher and add the milk and pieces of iced milk. Blend for 30 seconds or until very smooth. Pour into 4 glasses and serve immediately. Serves 4.

A Blue Tornado

Ingredients:

| | |
|------------|-----------------------------------|
| 1 Shot | Blue Curacao |
| 1 Shot | Premium Vodka |
| 3/4 Cup | Pineapple Juice |
| 1 1/2 Cups | Ice Cubes |
| 1 tsp. | Powdered Sugar |
| | Small Pineapple Wedge for Garnish |

Directions:

Place the curacao, vodka, juice and ice cubes in the pitcher and blend for 30 seconds or until smooth. Make a slice in the pineapple wedge. Press the wedge onto the rim of a tall glass and slide it all around the rim to moisten the glass. Then press the rim into a dish of powdered sugar. Pour the Blue Tornado into the glass and garnish with the pineapple wedge. Serves 1.

Chocolate Chip Milk Shake

Ingredients:

| | |
|---------|-----------------|
| 2 Cups | Ice Cream |
| 2 Tbsp. | Chocolate Chips |
| 3 Tbsp. | Cream |

Directions:

Add the ice cream, chocolate chips and cream to the pitcher and blend on Speed 3 for 10 seconds.





ONE (1) YEAR LIMITED WARRANTY

EURO-PRO Operating LLC warrants this product to be free from material defects and workmanship for a period of one (1) year from the date of purchase when utilized for normal household use, subject to the following conditions, exclusions and exceptions.

The liability of **EURO-PRO Operating LLC** is limited solely to the cost of the repair or replacement of the unit at our option. This Limited Warranty does not cover normal wear of parts and does not apply to any unit that has been tampered with or used for commercial purposes. This Limited Warranty does not cover damage caused by misuse, abuse, negligent handling or damage due to faulty packaging or mishandling in transit. This Limited Warranty does not cover damage or defects caused by or resulting from damages from shipping or repairs, service or alteration to the product or any of its parts, which have been performed by a repair person not authorized by **EURO-PRO Operating LLC**.

If your appliance fails to operate properly while in use under normal household conditions within the Limited Warranty period, you may return the complete appliance and accessories with proof of purchase and date, freight prepaid. For Customer Service support, call 1-800-798-7398 or visit our website www.ninjakitchen.com.

If the appliance is found by **EURO-PRO Operating LLC** to be defective, in **EURO-PRO Operating LLC's** sole discretion, we will repair or replace it free of charge. Proof of purchase date and a check made payable to **EURO-PRO Operating LLC** in the amount of \$19.95 to cover the cost of return shipping and handling must be included.*

This Limited Warranty is extended to the original purchaser of the unit and excludes all other legal, implied and/or conventional warranties. The responsibility of **EURO-PRO Operating LLC** if any, is limited to the specific obligations expressly assumed by it under the terms of this Limited Warranty. **In no event is EURO-PRO Operating LLC** liable for incidental or consequential damages to anyone of any nature whatsoever. Some states do not permit the exclusion or limitation of incidental or consequential damages, so the above may not apply to you.

This Limited Warranty gives you specific legal rights, and you may also have other rights which vary from state to state or from province to province.

***IMPORTANT: Carefully pack item to avoid damage in shipping. Be sure to include proof of purchase date and to attach tag to item before packing with your name, complete address and phone number with a note giving purchase information, model number and what you believe is the problem with the item. We recommend you insure the package (as damage in shipping is not covered by your Limited Warranty). Mark the outside of your package "ATTENTION CUSTOMER SERVICE". We are constantly striving to improve our products, therefore the specifications contained herein are subject to change without notice.**

Product Registration

Please visit www.ninjakitchen.com or call **1-800-798-7398** to register your new Ninja® product within ten (10) days of purchase. You will be asked to provide the store name, date of purchase and model number along with your name and address.

The registration will enable us to contact you in the unlikely event of a product safety notification. By registering you acknowledge to have read and understood the instructions for use, and warnings set forth in the accompanying instructions.