

# NINJA<sup>®</sup>

## Intelli-Sense™ Kitchen System

### CT680SS

---

#### INSTRUCTIONS



 [ninjakitchen.com](http://ninjakitchen.com)

 1-877-646-5288

# THANK YOU



for purchasing the Ninja® Intelli-Sense™ Kitchen System

---



 **TIP:** You can find the model and serial numbers on the QR code label located near the rating label.

## REGISTER YOUR PURCHASE

-  registeryourninja.com
-  1-877-646-5288
-  Scan QR code using mobile device

## RECORD THIS INFORMATION

Model Number: \_\_\_\_\_

Serial Number: \_\_\_\_\_

Date of Purchase (Keep receipt): \_\_\_\_\_

Store of Purchase: \_\_\_\_\_

## TECHNICAL SPECIFICATIONS

Voltage: 120V, 60Hz

Watts: 1200W

## PLEASE READ CAREFULLY AND KEEP FOR FUTURE REFERENCE.

These instructions are designed to help you get a complete understanding of your new Ninja Intelli-Sense Kitchen System.

If you have any questions, please call our Customer Service line at 1-877-646-5288.

# CONTENTS

---

<b>Important Safety Instructions</b> .....	<b>3</b>
<b>Getting to Know Your Ninja® Intelli-Sense™ Kitchen System</b> .....	<b>7</b>
<b>Before First Use</b> .....	<b>9</b>
<b>Features</b> .....	<b>10</b>
Total Crushing® Blender Pitcher .....	10
High-Speed Blender Cup .....	11
Precision Processor™ Bowl .....	12
<b>Using Your Total Crushing Blender Pitcher</b> .....	<b>13</b>
<b>Using Your High-Speed Blender Cup</b> .....	<b>17</b>
<b>Using your Precision Processor™ Bowl</b> .....	<b>21</b>
<b>Using Your Slicing/Shredding Disc</b> .....	<b>25</b>
<b>Care &amp; Maintenance</b> .....	<b>29</b>
Cleaning .....	29
Storing .....	29
Resetting the Motor Thermostat .....	29
Ordering Replacement Parts .....	29
<b>Troubleshooting Guide</b> .....	<b>30</b>
<b>Warranty</b> .....	<b>34</b>

# IMPORTANT SAFETY INSTRUCTIONS

PLEASE READ CAREFULLY BEFORE USE • FOR HOUSEHOLD USE ONLY

---

## WARNING

**When using electrical appliances, basic safety precautions should always be followed, including the following:**

- 1** Read all instructions prior to using the appliance and its accessories.
- 2** Carefully observe and follow all warnings and instructions. This unit contains electrical connections and moving parts that potentially present risk to the user.
- 3** This product is provided with a Stacked Blade Assembly and a Chopping Blade Assembly. Always exercise care when handling blade assemblies. The blade assemblies are sharp and are **NOT** locked in place in their containers. The blade assemblies are designed to be removable to facilitate cleaning and replacement if needed. **ONLY** grasp the blade assembly by the top of the shaft. Failure to use care when handling the blade assemblies will result in a risk of laceration.
- 4** **ALWAYS** exercise care when handling the Pro Extractor Blades® Assembly. The blades are sharp. **ONLY** grasp the Pro Extractor Blades Assembly by the outer perimeter of the blade assembly base. Failure to use care when handling the blade assembly will result in a risk of laceration.
- 5** Take your time and exercise care during unpacking and appliance setup. This appliance contains sharp, loose blades that can cause injury if mishandled.
- 6** Take inventory of all contents to ensure that you have all parts needed to properly and safely operate your appliance.
- 7** Unplug the appliance from the outlet when not in use, before assembling or disassembling parts, and before cleaning. To unplug, grasp the plug by the body and pull from the outlet. **NEVER** unplug by grasping and pulling the flexible cord.
- 8** Before use, wash all parts that may contact food. Follow washing instructions covered in this instruction manual.
- 9** To protect against the risk of electric shock, **DO NOT** submerge the appliance or allow the power cord to contact any form of liquid.
- 10** **DO NOT** use this appliance outdoors. It is designed for indoor household use only.

- 
- 11** This appliance has a polarized plug (one prong is wider than the other). To reduce the risk of electric shock, this plug will fit in a polarized outlet only one way. If the plug does not fit fully in the outlet, reverse the plug. If it still does not fit, contact a qualified electrician. **DO NOT** modify the plug in any way.
- 12 DO NOT** operate any appliance with a damaged cord or plug, or after the appliance malfunctions or is dropped or damaged in any manner. This appliance has no user-serviceable parts. If damaged, contact SharkNinja for servicing.
- 13** This appliance has important information on the plug prong. The power cord is not suitable for replacement. If damaged, contact SharkNinja for servicing in order to avoid a hazard.
- 14** Extension cords should **NOT** be used with this appliance.
- 15 DO NOT** allow young children to operate this appliance or use as a toy. Close supervision is necessary when any appliance is used near children.
- 16** This appliance is **NOT** intended to be used by people (including children) with reduced physical, sensory, or mental capabilities, or lack of experience and knowledge, unless they have been given supervision or instruction concerning use of the appliance by a person responsible for their safety.
- 17** Before each use, inspect blade assemblies for damage. If a blade is bent or damage is suspected, contact SharkNinja to arrange for replacement.
- 18 DO NOT** attempt to sharpen blades.
- 19 DO NOT** allow the unit or the cord to hang over the edges of tables or counters. The cord may become snagged and pull the appliance off the work surface.
- 20 DO NOT** allow the unit or the cord to contact hot surfaces, including stoves and other heating appliances.
- 21 ALWAYS** use the appliance on a dry and level surface.
- 22 NEVER** place a blade assembly on the motor base without it first being attached to its corresponding container (bowl, pitcher, cup) and lid.

**CONTINUED ON PAGE 5**

---

## **SAVE THESE INSTRUCTIONS**

# IMPORTANT SAFETY INSTRUCTIONS

PLEASE READ CAREFULLY BEFORE USE • FOR HOUSEHOLD USE ONLY

---

## **⚠ WARNING**

**When using electrical appliances, basic safety precautions should always be followed, including the following:**

- 23** Keep hands, hair, and clothing out of the container when loading and operating.
- 24 ONLY** use attachments and accessories that are provided with the product or are recommended by SharkNinja. The use of attachments not recommended or sold by SharkNinja may cause fire, electric shock or injury.
- 25** During operation and handling of the appliance, avoid contact with moving parts.
- 26 DO NOT** operate the appliance with an empty container.
- 27 DO NOT** fill containers past the MAX FILL or MAX LIQUID lines.
- 28 DO NOT** microwave any containers or accessories provided with the appliance.
- 29 DO NOT** perform grinding operations with the High-Speed Blender Cup and Pro Extractor Blades® Assembly.
- 30** Before operation, ensure that all utensils are removed from containers. Failure to remove utensils can cause containers to shatter and potentially result in personal injury and property damage.
- 31** When processing food, **ALWAYS** use the Food Pusher. **NEVER** feed ingredients into the Feed Chute Lid by hand or with other utensils. Failure to use the Food Pusher may cause personal injury.
- 32 NEVER** operate the appliance without lids and caps in place. **DO NOT** attempt to defeat the interlock mechanism. Ensure that the container and lid are properly installed before operation.
- 33 DO NOT** remove Feed Chute Lid until Blade Disc stops spinning.
- 34 DO NOT** expose the containers and accessories to extreme temperature changes. They may experience damage.
- 35 NEVER** leave the appliance unattended while in use.
- 36 DO NOT** open pour spout cap while blender is operating.
- 37 DO NOT** blend hot liquids. Doing so may result in pressure buildup and steam exposure that can pose a risk of the user being burned.
- 38** If you find unmixed ingredients sticking to the sides of the pitcher, stop the appliance, remove the lid, and use a spatula to dislodge ingredients. **NEVER** insert your hands into the pitcher, as you may contact one of the blades and experience a laceration.
- 39 DO NOT** attempt to remove the container and lids from the motor base while the blade assembly is still spinning. Allow the appliance to come to a complete stop before removing lids and containers.

- 
- 40** Upon completion of processing, ensure that the blade assembly is removed **BEFORE** emptying container's contents. Remove the blade assembly by carefully grasping the top of the shaft and lifting it from the container. Failure to remove the blade assembly before emptying the container results in a risk of laceration.
- 41** Remove the Pro Extractor Blades® Assembly from the High-Speed Blender Cup upon completion of blending. **DO NOT** store ingredients before or after blending them in the cup with the blade assembly attached. Some foods may contain active ingredients or release gases that will expand if left in a sealed container, resulting in excessive pressure buildup that can pose a risk of injury. For ingredient storage in the cup, use only Spout Lid to cover.
- 42** If the appliance overheats, a thermal switch will activate and temporarily disable the motor. To reset, unplug the appliance and allow it to cool for approximately 15 minutes before using again.
- 43** The maximum wattage rating for this appliance is based on the configuration of the Pro Extractor Blades Assembly and High-Speed Blender Cup. Other configurations may draw less power or current.
- 44 DO NOT** process dry ingredients without adding liquid to the High-Speed Blender Cup. The High-Speed Blender Cup is not intended for dry blending.
- 45** Always exercise care when handling the Slicing/Shredding Disc, as it is sharp. Use the finger holes when placing or removing disc. Failure to use the finger holes will result in a risk of laceration.
- 46 DO NOT** submerge the motor base or touchscreen in water or other liquids. **DO NOT** spray the motor base or touchscreen with any liquid. Turn off and unplug the motor base before cleaning.
- 47 DO NOT** overfill.
- 48 DO NOT** remove the container from the motor base while the appliance is in operation.
- 49** Keep hands, hair, clothing, as well as utensils out of container while processing to reduce the risk of severe injury to persons or damage to the appliance. A scraper may be used but only when the appliance is not running.
- 50** Avoid contact with moving parts.
- 51 DO NOT** attempt to operate the appliance without the lid on.

## SAVE THESE INSTRUCTIONS

# GETTING TO KNOW YOUR NINJA® INTELLI-SENSE™ KITCHEN SYSTEM

---

## WELCOME!

Congratulations on your purchase. Use this instruction manual to learn about the great features of your Ninja Intelli-Sense Kitchen System. From assembly to use to maintenance, you will find it all in here.

.....

There are a variety of accessories that are compatible with this blender series.

**NOTE: The top flap of your box shows the select accessories that are included with your model.**

If you have any questions, concerns or feedback, we'd love to hear from you. Give us a call at 1-877-646-5288 or visit [ninjakitchen.com](http://ninjakitchen.com).

\*64 oz. max liquid capacity.

## MAIN UNIT

- A** Pitcher Lid
- B** 72 oz. Total Crushing® Blender Pitcher\*
- C** Stacked Blade Assembly
- D** Motor Base with Smart Vessel Recognition
- E** 24 oz. High-Speed Blender Cup
- F** Spout Lid
- G** Pro Extractor Blades® Assembly
- H** Reversible Slicing/Shredding Disc
- I** Spindle for Slicing/Shredding Disc
- J** Two-Part Pusher for Feed Chute Lid
- K** Feed Chute Lid
- L** Dough Blade Assembly
- M** Chopping Blade Assembly
- N** Precision Processor™ Bowl



**A**

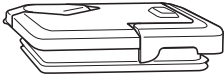

**B**

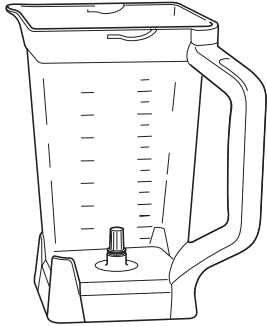

**C**



**H**



**J**

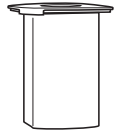

**K**

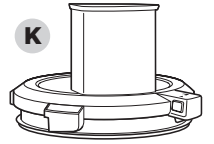

**D**

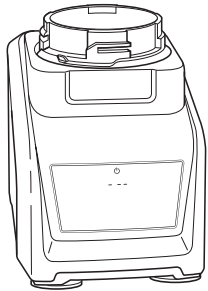

**E**

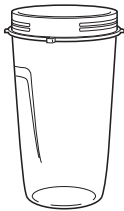

**F**



**G**



**N**



**I**



**L**

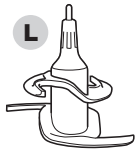

**M**



# BEFORE FIRST USE

---

★ **IMPORTANT:** Review all warnings on pages 3–6 before proceeding.

.....

## DID YOU KNOW?

- You can take your drinks on the go using the Spout Lids.
- All containers, blade assemblies, and lids are BPA free and dishwasher safe.

- 1** Remove all packaging materials from the appliance. Exercise care when unpacking blade assemblies. All blade assemblies are sharp.
- 2** The Chopping Blade Assembly and Stacked Blade Assembly are **NOT** locked in place in their containers. Handle the Chopping Blade Assembly and Stacked Blade Assembly by grasping the top of the shaft.
- 3** Handle the Pro Extractor Blades® Assembly by grasping around the perimeter of the blade assembly base.
- 4** Wash containers, lids, and blade assemblies in warm, soapy, water using a dishwashing utensil with a handle to avoid direct contact with the blades. Exercise care when handling blade assemblies, as the blades are sharp.
- 5** Thoroughly rinse and air-dry all parts.
- 6** All attachments are dishwasher safe. It is recommended that the lids, containers, and blade assemblies be placed on the top rack of the dishwasher. Ensure blade assemblies are removed from their containers before placing in the dishwasher. Exercise care when handling blade assemblies.
- 7** Wipe touchscreen with a soft cloth. Allow it to dry completely before using.

# FEATURES

---

## SMART PROGRAMS FOR THE TOTAL CRUSHING® BLENDER PITCHER

Intelligent pre-set programs that combine unique blending and pausing patterns that do the work for you. Once a pre-set program is selected, it will start immediately. Press STOP to end it.

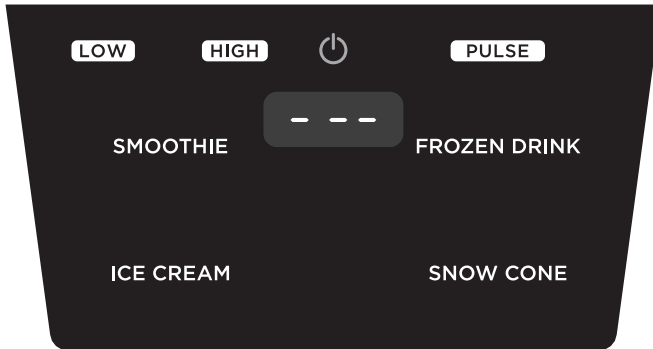

 The power symbol should be used to turn your appliance on or off.

### SMOOTHIE

Make super-smooth, sippable drinks and shakes from fresh or frozen fruit, milk, liquids, and ice.

### ICE CREAM

Create delicious and scoop-able frozen desserts like ice cream or sorbet.

### FROZEN DRINK

Turn ice, juices, and fruit into expertly blended frozen drinks.

### SNOW CONE

Pulverize ice into frozen creations like snow cones, slushies, or granitas.

### LOW, HIGH, and PULSE

When selected, each of these programs runs continuously until turned off. They do not work in conjunction with any pre-set programs.

# FEATURES - CONT.

---

## SMART PROGRAMS FOR THE HIGH-SPEED BLENDER CUP

Intelligent pre-set programs that combine unique blending and pausing patterns that do the work for you. Once a pre-set program is selected, it will start immediately. Press STOP to end it.

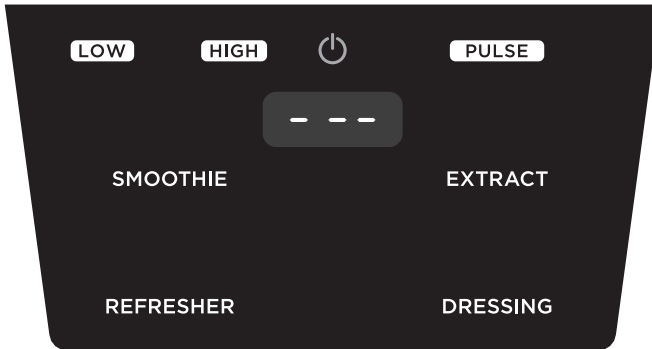

 The power symbol should be used to turn your appliance on or off.

### SMOOTHIE

Make super-smooth, sippable drinks and shakes from fresh or frozen fruit, milk, liquids, and ice.

### REFRESHER

Add natural veggie, fruit, and herb flavors to your water.

### EXTRACT

Ideal for tough, leafy, or fibrous whole fruits and vegetables, including their skins, seeds, and stems.

### DRESSING

Create fresh marinades, dressings, and sauces.

### LOW, HIGH, and PULSE

When selected, each of these programs runs continuously until turned off. They do not work in conjunction with any pre-set programs.

---

## SMART PROGRAMS FOR THE PRECISION PROCESSOR™ BOWL

Intelligent pre-set programs that combine unique blending and pausing patterns that do the work for you. Once a pre-set program is selected, it will start immediately. Press STOP to end it.

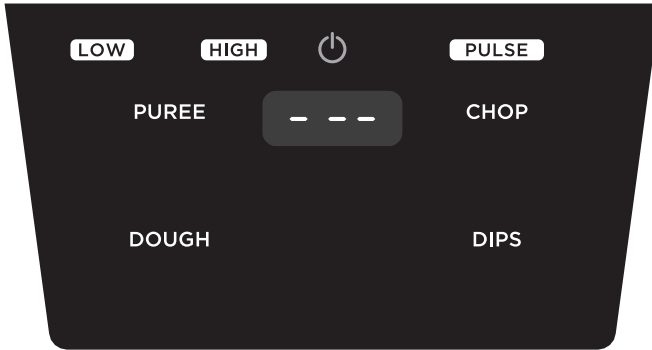

 The power symbol should be used to turn your appliance on or off.

### **PUREE**

Create anything from silky smooth sauces to the perfect hummus.

### **DOUGH**

Ideal for creating delicious dough for pizza, bread, and baked goods like cookies.

### **CHOP**

Timed pulses and pauses to give you consistent chopping results.

### **DIPS**

Use for dips and sides with more texture like spinach and artichoke dip or mashed potatoes.

### **LOW, HIGH, and PULSE**

When selected, each of these programs runs continuously until turned off. They do not work in conjunction with any pre-set programs.

# USING YOUR TOTAL CRUSHING® BLENDER PITCHER

★ **IMPORTANT:** Review all warnings on pages 3–6 before proceeding.

💡 **TIP:** If the Stacked Blade Assembly is not fully seated, you will not be able to install and lock the lid.

💡 **TIP:** To learn more about the unit's programs, refer to page 10.

**NOTE:** Pre-set programs have pauses and changes in speed throughout the cycle.

**NOTE: DO NOT** add ingredients before completing installation of the Stacked Blade Assembly.

**NOTE:** The pitcher can only be installed in one orientation. The handle must be positioned on the front-right corner of the motor base to operate the appliance.

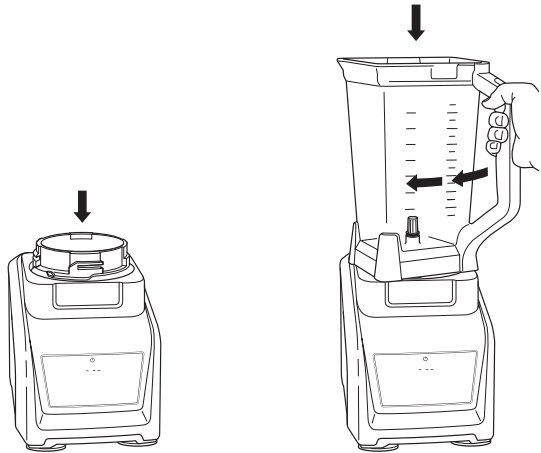

- 1** Place the unplugged motor base on a clean, dry, and level surface such as a countertop or table. Press downward on the motor base to adhere the suction cups to the work surface. Ensure the motor base is connected to power.
- 2** Lower the Total Crushing Blender pitcher onto the motor base. The handle should be aligned slightly to the right and the pitcher should be oriented so the LOCK symbols are visible on the motor base. Then rotate the pitcher clockwise until it clicks into place.

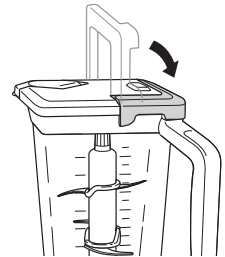
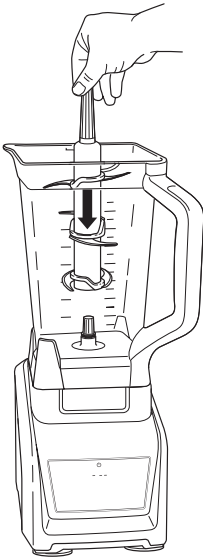

- 3** Exercising care, grasp the Stacked Blade Assembly by the top of the shaft and place it onto the drive gear inside the pitcher. Note that the blade assembly will fit loosely onto the drive gear.
- 4** Add ingredients, making sure to not exceed the Max Fill line marked on the side of the pitcher.
- 5** Place the lid on the pitcher, aligning the triangle symbol located on the lid with the triangle symbol located on the pitcher's handle. Press down on the handle until it clicks into place. The triangle symbols **MUST** be aligned for the lid to lock onto place and the unit to operate. When the unit is connected to power and the container is correctly locked into the motor base, the available program buttons will illuminate and the unit will be ready for use.

# USING YOUR TOTAL CRUSHING® BLENDER PITCHER - CONT.

★ **IMPORTANT:** Review all warnings on pages 3–6 before proceeding.

★ **IMPORTANT:** As a safety feature, if the pitcher and lid are not properly installed, the timer will display “- --” and the motor will be disabled. If this happens, repeat step 5 on page 14. When the pitcher and lid are properly installed, the program buttons will illuminate steadily, indicating the appliance is ready for use.

**NOTE:** Smart Vessel Recognition can detect which container is on the motor base. Only the functions available for a particular container will illuminate on the touchscreen.

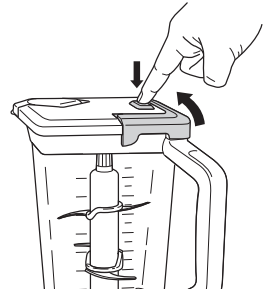
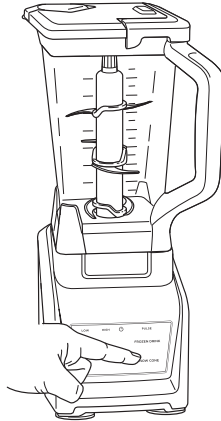

- 6 If using a pre-set program, first select the program that best suits your recipe. The pre-set feature will automatically stop the appliance at the end of the program. To pause the unit at any time, press the currently active button a second time. Reference page 10 for program descriptions.
- 7 If not using a pre-set program and ingredients have reached your desired consistency, stop the appliance by releasing the manual speed button, and wait for the appliance to come to a complete stop.
- 8 To remove the pitcher from the motor base, turn the pitcher counterclockwise and lift it up.



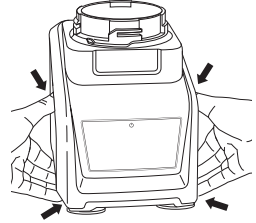
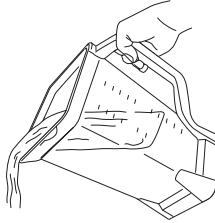
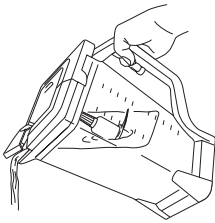

**9** To pour out thinner mixtures, ensure the lid is locked in place, then open the pour spout cap.

**10** For thicker mixtures that cannot be emptied through the pour spout, remove the lid and Stacked Blade Assembly before pouring. To remove the lid, press the RELEASE button and lift the handle. To remove the blade assembly, carefully grasp it by the top of the shaft. The pitcher can then be emptied.

**11** Unplug the unit when finished. To release the motor base, place your hands underneath both sides of the motor base and gently pull the unit up and towards you. Refer to page 29 for storing instructions.

# USING YOUR HIGH-SPEED BLENDER CUP

---

★ **IMPORTANT:** Review all warnings on pages 3–6 before proceeding.

💡 **TIP:** To learn more about the unit's programs, refer to page 11.

.....

**NOTE:** Pre-set programs have pauses and changes in speed throughout the cycle.

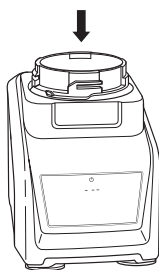

- 1** Place the unplugged motor base on a clean, dry, and level surface such as a countertop or table. Press downward on the motor base to adhere the suction cups to the work surface. Plug the motor base into a wall outlet.
- 2** Add ingredients to the High-Speed Blender Cup. **DO NOT** add ingredients past the MAX LIQUID line on the cup.



- 3** Install the Pro Extractor Blades® Assembly onto the top of the cup. Twist the lid clockwise until it's sealed tightly.

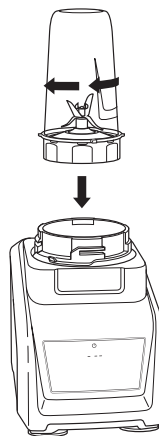

- 4** Turn the High-Speed Blender Cup upside down and install onto the motor base. Align the tabs on the cup with the slots on the base, then twist until it clicks into place. When the unit is connected to power and the container is correctly locked onto the motor base, the available program buttons will illuminate and the unit will be ready for use.

# USING YOUR HIGH-SPEED BLENDER CUP - CONT.

---

★ **IMPORTANT:** Review all warnings on pages 3–6 before proceeding.

.....

**NOTE:** Smart Vessel Recognition can detect which container is on the motor base. Only the functions available for a particular container will illuminate on the touchscreen.

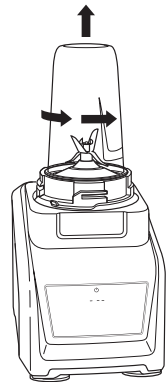
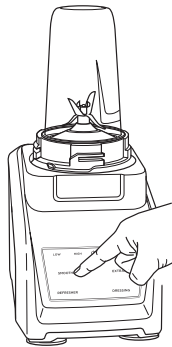

- 5** If using a pre-set program, first select the program that best suits your recipe. The pre-set feature will automatically stop the appliance at the end of the program. To pause the unit at any time, press the currently active program a second time. Reference page 11 for program descriptions.
- 6** To remove the cup from the motor base, turn the cup counterclockwise and then lift it.



**7** Remove the Pro Extractor Blades® Assembly by twisting the cap counter-clockwise. Do not store blended contents with Pro Extractor Blades Assembly attached. Exercise care when handling the blade assembly, as the blades are sharp.

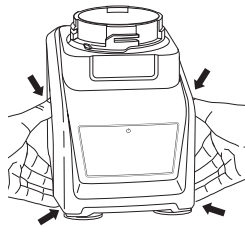

**8** Unplug the unit when finished. To release the motor base, place your hands underneath both sides of the motor base and gently pull the unit up and towards you. Refer to page 29 for storing instructions.



**9** To enjoy your drink on the go, place the Spout Lid onto the High-Speed Blender Cup and twist lid clockwise until firmly sealed. For storing ingredients in the cup, use only the Spout Lid to cover.

# USING YOUR PRECISION PROCESSOR™ BOWL

★ **IMPORTANT:** Review all warnings on pages 3–6 before proceeding.

💡 **TIP:** If the blade assembly is not fully seated, you will not be able to install and lock the lid into position.

💡 **TIP:** To learn more about the unit's programs, refer to page 12.

**NOTE:** Pre-set programs have pauses and changes in speed throughout the cycle.

**NOTE: DO NOT** add ingredients before installing the blade assembly.

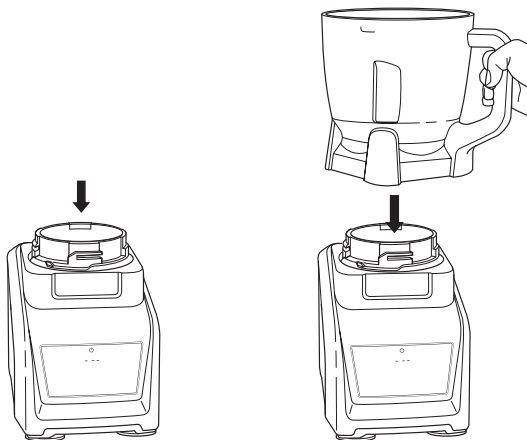

- 1** Place the unplugged motor base on a clean, dry, and level surface such as a countertop or table. Press downward on the motor base to adhere the suction cups to the work surface. Plug the motor base into a wall outlet.
- 2** Lower the Precision Processor bowl onto the motor base.

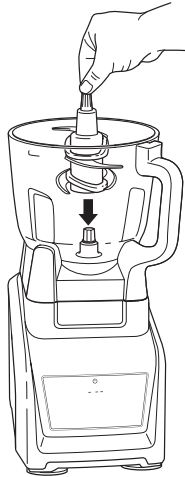
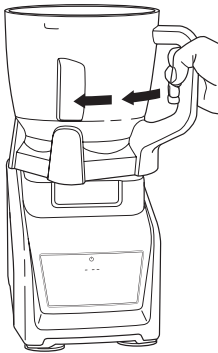

- 3** Rotate Precision Processor™ bowl clockwise until it clicks into place.
- 4** Exercising care, grasp the Chopping Blade Assembly by the top of the shaft and place it onto the drive gear inside the bowl. Note that the Chopping Blade Assembly will fit loosely onto the drive gear.
- 5** Add ingredients to the bowl, making sure not to overfill.

# USING YOUR PRECISION PROCESSOR™ BOWL - CONT.

★ **IMPORTANT:** Review all warnings on pages 3–6 before proceeding.

.....

**NOTE:** Please follow the same instructions to install the Dough Blade Assembly.

**NOTE:** Smart Vessel Recognition can detect which container is on the motor base. Only the functions available for a particular container will illuminate on the touchscreen.

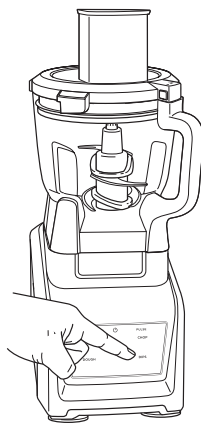
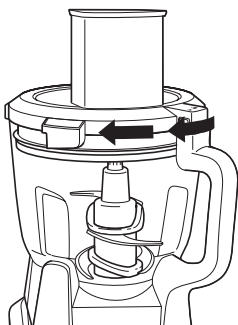

- 6** Place the feed chute lid on the bowl and turn clockwise until you hear a click, indicating the lid is locked in place. When the unit is connected to power and the container is correctly locked onto the motor base, the available program buttons will illuminate and the unit will be ready for use.
- 7** If using a pre-set program, first select the program that best suits your recipe. The pre-set feature will automatically stop the appliance at the end of the program. To pause the unit at any time, press the currently active program a second time. Reference page 12 for program descriptions.



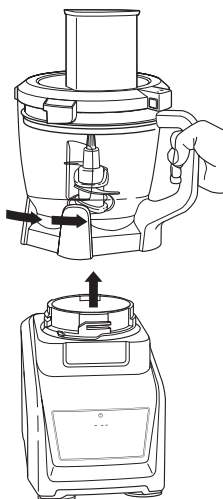

- 8** To remove the bowl from the motor base, turn the bowl counterclockwise and then lift it.

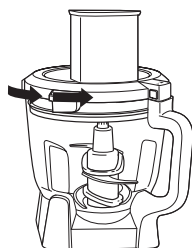

- 9** Press the button on the feed chute lid located near the handle to unlock and turn the lid counterclockwise. Lift to remove from the food processor bowl. Always remove the Chopping Blade Assembly before emptying any of the ingredients in the bowl. To remove the Chopping Blade Assembly, carefully grasp it by the top of the shaft and lift it out of the bowl.

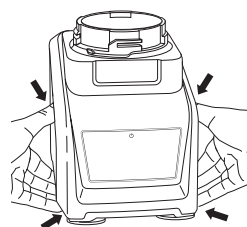

- 10** Unplug the unit when finished. To release the motor base, place your hands underneath both sides of the motor base and gently pull the unit up and towards you. Refer to page 29 for storing instructions.

# USING YOUR SLICING/SHREDDING DISC

★ **IMPORTANT:** Review all warnings on pages 3-6 before proceeding.

★ **IMPORTANT:** Only use LOW when using the Slicing/Shredding Disc.

**NOTE:** The feed chute lid features a two-part pusher to guide food through the chute. Use the full pusher for larger items such as cucumbers. Twist and pull to remove the smaller pusher and use the narrow chute for smaller items such as carrots.

**NOTE:** The Slicing/Shredding Disc is reversible. Use the side labeled “Slicer” for Slicing. Carefully flip the disc over to the side labeled “Shredder” for shredding.

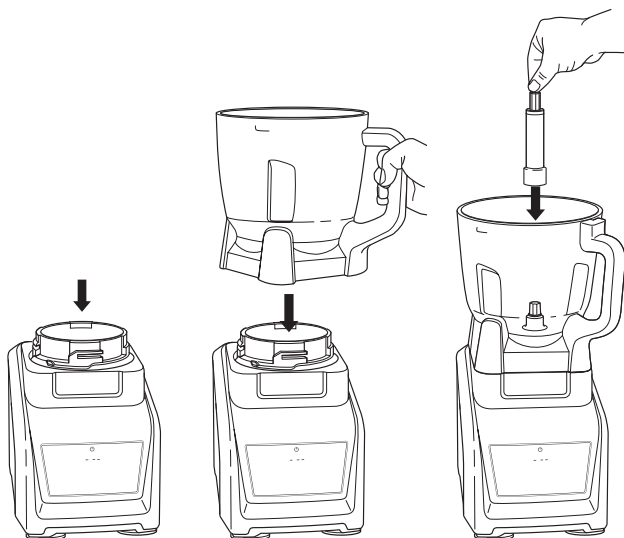

- 1** Place the motor base on a clean, dry, level surface such as a counter or tabletop. Press down on the motor base to make sure that the suction cups adhere to the counter or tabletop.
- 2** Secure the bowl onto the motor base.
- 3** Place the spindle inside the bowl.

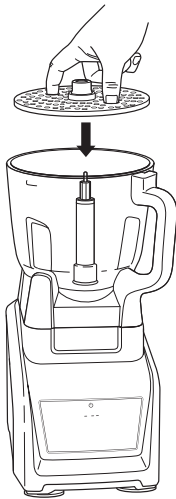

**4** Use the finger holes to grasp the disc and place it over the spindle.

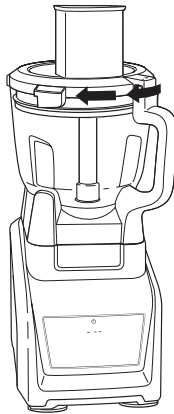

**5** Place the feed chute lid on the bowl and turn clockwise until you hear a click, indicating the lid is locked in place.

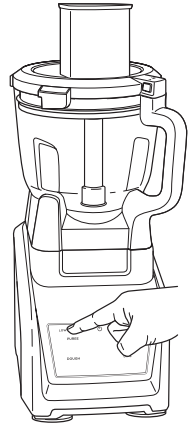

**6** Plug the power cord into the electrical outlet and press the power button to turn the unit on.

**7** Select LOW on the control panel. The disc will begin spinning.

## USING YOUR SLICING/SHREDDING DISC - CONT.

★ **IMPORTANT:** Review all warnings on pages 3-6 before proceeding.

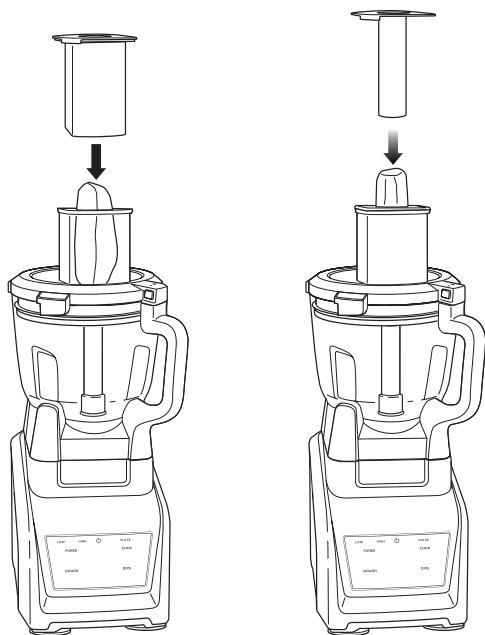

- 8 Add the food that you want to slice or shred through the feed chute on the lid. Use the two-part food pusher to help guide the food through the feed chute. The middle piece of the food pusher is removable to use for smaller ingredients.

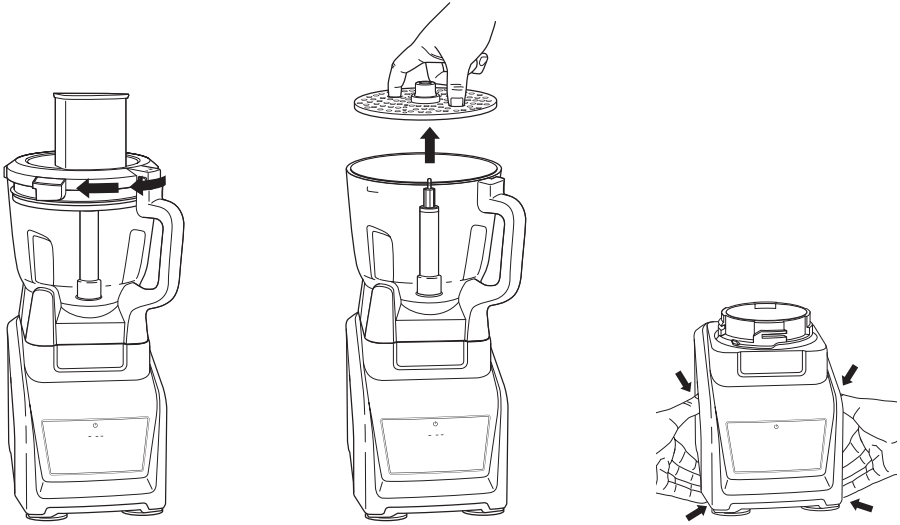

**9** When finished, stop the appliance by pressing the power button and wait for the disc to stop turning. Press the button on the feed chute lid located near the handle to unlock and turn the lid counterclockwise. Lift to remove from the food processor bowl. Using the finger holes, carefully lift the Slicing/Shredding Disc out of the bowl and remove the spindle.

**10** To release the motor base from the counter or tabletop, lift the base up from underneath the sides of the unit. The release paddles on both sides will help to disengage the suction feet from the surface.

# CARE & MAINTENANCE

---

## CLEANING

- 1 Separate all parts.
- 2 Wash all containers in warm, soapy water with a soft cloth.
- 3 **Hand Washing**  
Wash blade assemblies in warm, soapy water using a dishwashing utensil with a handle or the provided cleaning brush to avoid direct contact with the blades. Exercise care when handling blade assemblies as the blades are sharp. Thoroughly rinse and air-dry all parts.

### Dishwasher

All attachments are dishwasher safe. It is recommended that the lids, containers, and blade assemblies be placed on the top rack of the dishwasher **ONLY**. Ensure the blade assemblies are removed from their containers before placing in the dishwasher. Exercise care when handling blade assemblies.

### Motor Base

Turn off the unit and unplug the motor base before cleaning. Wipe motor base with a clean, damp cloth.

Clean the touchscreen with a soft cloth, such as microfiber, to prevent scratching. To remove residue from the touchscreen, you may use an all-purpose cleaner.

**NEVER** spray the base or touchscreen with water or other liquids.

**DO NOT** use abrasive cloths/pads/brushes to clean the base or touchscreen, as this can dull or scratch the surface.

## STORING

Wrap the power cord around the cord wrap on the back of the motor base. Store the unit upright and store all blade assemblies inside or attached to their respective containers with their lids locked into place.

**DO NOT** store blended or unblended ingredients in the High-Speed Blender Cup with the Pro Extractor Blades® assembly attached.

**DO NOT** stack items on top of the containers. Store any remaining attachments alongside the unit or in a cabinet where they will not be damaged or create a hazard.

## RESETTING THE MOTOR THERMOSTAT

This unit features a unique safety system that prevents damage to the motor and drive system should you inadvertently overload the it. If the unit is overloaded, the motor will be temporarily disabled. Should this occur, follow the reset procedure below.

- 1 Unplug the unit from the electrical outlet.
- 2 Allow the unit to cool for approximately 15 minutes.
- 3 Remove the container's lid and blade assembly. Empty the container and ensure no ingredients are jamming the blade assemblies.

**IMPORTANT:** Ensure that maximum capacities are not exceeded. This is the most typical cause of appliance overload.

If your unit needs servicing, please call Customer Service at 1-877-646-5288.

## ORDERING REPLACEMENT PARTS

To order additional parts and attachments, please visit [ninjaaccessories.com](http://ninjaaccessories.com) or contact Customer Service at 1-877-646-5288.

# TROUBLESHOOTING GUIDE

---

**⚠ WARNING: To reduce the risk of shock and unintended operation, turn power off and unplug unit before troubleshooting.**

## **Unit doesn't turn on.**

- Make sure unit is plugged in.
- Display will read "--" once connected to power.
- Place container on base and rotate it clockwise until it clicks into place. Available programs will illuminate, indicating the unit is ready for use.

## **Unit doesn't turn off.**

- Remove container from base by rotating it counterclockwise and lifting it. Display should turn off. Unplug the power cord from the outlet.

## **Lid/Pro Extractor Blades® Assembly is hard to install on the cup.**

- Set the cup on a level surface. Carefully place the lid or Pro Extractor Blades Assembly on the top of the cup and align the threads so the lid/Pro Extractor Blades Assembly sits flat on the cup. Twist clockwise until you have a tight seal.

## **Food is not evenly chopped.**

- For best results when chopping, cut pieces down to even sizes and do not overfill the Precision Processor™ bowl.

## **Doesn't mix well; ingredients get stuck.**

- Using the pre-set programs is the easiest way to achieve great results. The pulses and pauses allow the ingredients to settle toward the blade assembly. If ingredients are routinely getting stuck, adding some liquid will usually help.
- When filling the cup, start with fresh fruit or veggies, then leafy greens or herbs. Next add liquids or yogurt, then seeds, powders, or nut butters. Finally, add ice or frozen ingredients.

## **Motor base won't stick to counter or tabletop.**

- Make sure surface and suction feet are wiped clean. Suction feet will only stick to smooth surfaces.
- Suction feet **WILL NOT** stick on some surfaces such as wood, tile, and non-polished finishes.
- **DO NOT** attempt to use unit when the motor base is stuck to a surface that is not secure (cutting board, platter, plates, etc.).

## **Unit is difficult to remove from counter for storage.**

- Place your hands underneath both sides of the motor base and gently pull the unit up and towards you.

## **You get a blinking "--" Message**

- Smart Vessel Recognition can detect which container is on the motor base. You may be trying to use a program that is not designed for the container you have installed. The programs will light up, indicating which programs are available for each container.

## **You cannot create snow from solid ice.**

- Do not use ice that has been sitting out or has started to melt. Use ice straight from the freezer.
- Start with a few pulses and then go to a continuous blending cycle.

**NOTES**

---

---

---

---

---

---

---

---

---

---

---

---

---

---

---

---

---

---

---

---

---

---

---

---

---





# NOTES

---

---

---

---

---

---

---

---

---

---

---

---

---

---

---

---

---

---

---

---

---

---

---

# Shark | NINJA ONE (1) YEAR LIMITED WARRANTY

---

The 1-Year Limited Warranty applies to purchases made from authorized retailers of SharkNinja Operating LLC. Warranty coverage applies to the original owner and to the original product only and is not transferable.

SharkNinja warrants that the unit shall be free from defects in material and workmanship for a period of 1 year from the date of purchase when it is used under normal household conditions and maintained according to the requirements outlined in this instruction manual, subject to the following conditions and exclusions.

## **What is covered by my warranty?**

1. The original unit and/or non-wearable components deemed defective, in SharkNinja's sole discretion, will be repaired or replaced for up to 1 year from the original purchase date.
2. In the rare event that a replacement unit is issued, the warranty coverage ends six months after the receipt date of the replacement unit or the remainder of the existing warranty, whichever is greater. If the unit is replaced, SharkNinja reserves the right to replace the unit with one of equal or greater value.

## **What is not covered by my warranty?**

Our Customer Service and Product Specialists are available to provide all the warranty service options available to you, including the possibility of upgrading to our VIP Warranty Service Options for select product categories.

1. Normal wear and tear of wearable parts (including all blending vessels, lids, blades and blender base) which require regular maintenance and/or replacement to ensure the proper functioning of your unit are not covered by this warranty.
2. Any unit that has been tampered with or used for commercial purposes.
3. SharkNinja will cover the cost for the customer to send the unit to us for repair or replacement. A fee of \$19.95 for return shipping costs will be charged at the time of return shipment of the repaired or replacement unit.
4. Damage caused by misuse, abuse, or negligent handling, or damage due to mishandling in transit.
5. Consequential and incidental damages.
6. Defects caused by or resulting from damages from shipping or from repairs, service, or alteration to the product or any of its parts which have been performed by a repair person not authorized by SharkNinja.
7. Products purchased, used or operated outside of North America.

## **Problems with your unit/How to get service:**

If your appliance fails to operate properly while in use under normal household conditions within the warranty period, visit [ninjakitchen.com](http://ninjakitchen.com) for product care/maintenance self-help. Our Customer Service and Product Specialists are also available at 1-877-646-5288 to assist with product support and warranty service options.

## **How to initiate a warranty claim:**

You can call 1-877-646-5288 to have a Customer Service specialist assist you. Please note, you must call 1-877-646-5288 to initiate a warranty claim. Return and packing instruction information will be provided at that time.

For Customer Service hours, visit [ninjakitchen.com](http://ninjakitchen.com).

Replacement parts are available for purchase at [ninjaaccessories.com](http://ninjaaccessories.com). For more information on what are classified as wearable and non-wearable parts, please visit [ninjakitchen.com/warranty](http://ninjakitchen.com/warranty).

This warranty gives you specific legal rights, and you may also have other rights that vary from state to state.

Some states do not permit the exclusion or limitation of incidental or consequential damages, so the above may not apply to you.



**SharkNinja Operating LLC**  
**US: Needham, MA 02494**  
**CAN: Ville St-Laurent, QC H4S 1A7**  
**1-877-646-5288**  
**ninjakitchen.com**

Illustrations may differ from actual product. We are constantly striving to improve our products; therefore the specifications contained herein are subject to change without notice.

NINJA, PRO EXTRACTOR BLADES, and TOTAL CRUSHING are registered trademarks of SharkNinja Operating LLC.

INTELLI-SENSE and PRECISION PROCESSOR are trademarks of SharkNinja Operating LLC.

For SharkNinja U.S. Patent information, visit [sharkninja.com/USPatents](http://sharkninja.com/USPatents).

© 2017 SharkNinja Operating LLC  
CT680SS\_IB\_E\_MP\_170721  
PRINTED IN CHINA



**@ninjakitchen**