

NINJA®

4-IN-1 KITCHEN SYSTEM™

NN210Q

Model

INSTRUCTIONS



 ninjakitchen.com

 1-877-646-5288

THANK YOU

for purchasing the Ninja® 4-in-1 Kitchen System™



TIP: You can locate the model number and date code on the plug prong.

REGISTER YOUR PURCHASE



registeryourninja.com



1-877-646-5288

RECORD THIS INFORMATION

Model Number: _____

Date Code: _____

Date of Purchase (Keep receipt): _____

TECHNICAL SPECIFICATIONS

Voltage: 120V, 60Hz

Watts: 1200W

PLEASE READ CAREFULLY AND KEEP FOR FUTURE REFERENCE.

These instructions are designed to help you get a complete understanding of your new Ninja 4-in-1 Kitchen System.

If you have any questions, please call our customer service line at 1-877-646-5288.

CONTENTS

Important Safety Instructions	3
Getting to Know Your Ninja® 4-in-1 Kitchen System™	7
Features	9
Before First Use	10
Using Your High-Speed Blender Cup	11
Using Your Precision Processor™ Bowl	15
Assembling Your Auto-Spiralizer™	19
Using Your Auto-Spiralizer	21
Using Your Total Crushing® Blender Pitcher	25
Suggested Uses & Filling Instructions	29
Filling Your High-Speed Blender Cup.....	29
Ordering Replacement Parts	29
Care & Maintenance	30
Cleaning	30
Storing.....	30
Resetting the Motor Thermostat.....	30
Troubleshooting Guide	31
Warranty	34

IMPORTANT SAFETY INSTRUCTIONS

PLEASE READ CAREFULLY BEFORE USE • FOR HOUSEHOLD USE ONLY

⚠ WARNING

When using electrical appliances, basic safety precautions should always be followed, including the following:

- 1** Read all instructions prior to using the appliance and its accessories.
- 2** Carefully observe and follow all warnings and instructions. This unit contains electrical connections and moving parts that potentially present risk to the user.
- 3** This product is provided with a Stacked Blade Assembly and a Chopping Blade Assembly. Always exercise care when handling blade assemblies. The blade assemblies are sharp and are NOT locked in place in their containers. The blade assemblies are designed to be removable to facilitate cleaning and replacement if needed. **ONLY** grasp the blade assembly by the top of the shaft. Failure to use care when handling the blade assemblies will result in a risk of laceration.
- 4** **ALWAYS** exercise care when handling the Pro Extractor Blades® Assembly. The blades are sharp. **ONLY** grasp the Pro Extractor Blades Assembly by the outer perimeter of the blade assembly base. Failure to use care when handling the blade assembly will result in a risk of laceration.
- 5** Take your time and exercise care during unpacking and appliance setup. This appliance contains sharp, loose blades that can cause injury if mishandled.
- 6** Take inventory of all contents to ensure that you have all parts needed to properly and safely operate your appliance.
- 7** Unplug the appliance from the outlet when not in use, before assembling or disassembling parts, and before cleaning. To unplug, grasp the plug by the body and pull from the outlet. Never unplug by grasping and pulling the flexible cord.
- 8** Before use, wash all parts that may come in contact with food. Follow washing instructions covered in this instruction manual.
- 9** To protect against the risk of electric shock, **DO NOT** submerge the appliance or allow the power cord to contact any form of liquid.
- 10** **DO NOT** use this appliance outdoors. It is designed for indoor household use only.

-
- 11** This appliance has a polarized plug (one blade is wider than the other). To reduce the risk of electric shock, this plug will fit in a polarized outlet only one way. If the plug does not fit fully in the outlet, reverse the plug. If it still does not fit, contact a qualified electrician. DO NOT modify the plug in any way.
- 12** DO NOT operate any appliance with a damaged cord or plug, or after the appliance malfunctions, or has been dropped or damaged in any manner. This appliance has important information on the plug prong. The entire cord set is NOT suitable for replacement. If damaged, please contact SharkNinja LLC for service.
- 13** Extension cords should NOT be used with this appliance.
- 14** DO NOT allow young children to operate this appliance or use as a toy. Close supervision is necessary when any appliance is used near children.
- 15** This appliance is NOT intended to be used by people (including children) with reduced physical, sensory, or mental capabilities, or lack of experience and knowledge, unless they have been given supervision or instruction concerning use of the appliance by a person responsible for their safety.
- 16** Before each use, inspect blade assemblies for damage. If a blade is bent or damage is suspected, contact SharkNinja to arrange for replacement.
- 17** DO NOT attempt to sharpen blades.
- 18** DO NOT allow the cord to hang over the edges of tables or counters. The cord may become snagged and pull the appliance off the work surface.
- 19** DO NOT allow any part of the unit or cord to contact hot surfaces, including stoves and other heating appliances.
- 20** ALWAYS use the appliance on a dry and level surface.
- 21** NEVER place a blade assembly on the motor base without it first being attached to its corresponding container (bowl, pitcher, cup) and lid.

CONTINUED ON PAGE 5

SAVE THESE INSTRUCTIONS

IMPORTANT SAFETY INSTRUCTIONS

PLEASE READ CAREFULLY BEFORE USE • FOR HOUSEHOLD USE ONLY

⚠ WARNING

When using electrical appliances, basic safety precautions should always be followed, including the following:

- 22** Keep hands, hair, and clothing out of the container when loading and operating.
- 23** ONLY use attachments and accessories that are provided with the product or are recommended by SharkNinja.
- 24** During operation and handling of the appliance, avoid contact with moving parts.
- 25** DO NOT operate the appliance with an empty container.
- 26** DO NOT fill containers past the max fill or max liquid lines.
- 27** DO NOT microwave any containers or accessories provided with the appliance.
- 28** DO NOT perform grinding operations with the High-Speed Blender Cup and Pro Extractor Blades® Assembly.
- 29** Before operation, ensure that all utensils are removed from containers. Failure to remove utensils can cause containers to shatter and potentially result in personal injury and property damage.
- 30** Keep hands and utensils out of containers while chopping to reduce the risk of severe personal injury or damage to the blender/food chopper. A scraper may ONLY be used when the food chopper is not running.
- 31** NEVER operate the appliance without lids and caps in place. DO NOT attempt to defeat the interlock mechanism. Ensure that the container and lid are properly installed before operation.
- 32** DO NOT expose the containers and accessories to extreme temperature changes. They may experience damage.
- 33** NEVER leave the appliance unattended while in use.
- 34** DO NOT open pour spout cover while blender is operating.
- 35** DO NOT blend hot liquids. Doing so may result in a pressure buildup and steam exposure that can pose a risk of the user being burned.
- 36** If you find unmixed ingredients sticking to the sides of the pitcher, stop the appliance, remove the lid, and use a spatula to dislodge ingredients. NEVER insert your hands into the pitcher, as you may contact one of the blades and experience a laceration.
- 37** DO NOT attempt to remove the container and lids from the motor base while the blade assembly is still spinning. Allow the appliance to come to a complete stop before removing lids and containers.

-
- 38** Upon completion of processing, ensure that the blade assembly is removed BEFORE emptying container's contents. Remove the blade assembly by carefully grasping the top of the shaft and lifting it from the container. Failure to remove the blade assembly before emptying the container results in a risk of laceration.
- 39** Remove the Pro Extractor Blades® Assembly from the High-Speed Blender cup upon completion of blending. DO NOT store ingredients before or after blending them in the cup with the blade assembly attached. Some foods may contain active ingredients or release gases that will expand if left in a sealed container, resulting in excessive pressure buildup that can pose a risk of injury. For ingredient storage in the cup, use only Spout Lid to cover.
- 40** If the appliance overheats, a thermal switch will activate and temporarily disable the motor. To reset, unplug the appliance and allow it to cool for approximately 15 minutes before using again.
- 41** The maximum wattage rating for this appliance is based on the configuration of the Pro Extractor Blades Assembly and High-Speed Blender cup. Other configurations may draw less power or current.
- 42** DO NOT process dry ingredients without adding liquid to the High-Speed Blender cup. The High-Speed Blender cup is not intended for dry blending.
- 43** The Blade Discs are sharp. Always use the handles on the side of each Blade Disc when placing it into the Bowl or removing it. Follow all cleaning instructions. Failure to do so will result in a risk of laceration.
- 44** When using the Spiralizer, ALWAYS use the Food Pusher. NEVER feed ingredients into the Spiralizer by hand or with other utensils. Failure to use the Food Pusher may cause personal injury.
- 45** If Blade Discs appear to be damaged or broken, do not use or attempt to repair. Call customer service for assistance.
- 46** DO NOT attempt to sharpen Blade Discs.
- 47** DO NOT remove Feed Chute Lid until Blade Disc stops spinning.

SAVE THESE INSTRUCTIONS

GETTING TO KNOW YOUR NINJA® 4-IN-1 KITCHEN SYSTEM™

WELCOME!

Congratulations on your purchase. Use this instruction manual to learn about the great features of your Ninja 4-in-1 Kitchen System. From assembly to use to maintenance, you will find it all in here.

.....

There are a variety of accessories that are compatible with this blender series.

NOTE: The top flap of your box shows the select accessories that are included with your model.

If you have any questions, concerns or feedback, we'd love to hear from you. Give us a call at 1-877-646-5288 or visit ninjakitchen.com/customersupport

To find great recipes and purchase more accessories (including more Blade Discs for creating different types of noodles) please visit ninjaaccessories.com

* 3.5 cups max capacity,
15 oz. max liquid capacity.

** 64 oz. max liquid capacity.

MAIN UNIT

- A** Spout Lid
- B** Pro Extractor Blades® Assembly
- C** 24 oz. High-Speed Blender Cup
- D** Motor Base
- E** Precision Processor™ Bowl Lid
- F** Precision Processor Bowl*
- G** Dough Blade Assembly
- H** Chopping Blade Assembly
- I** Pitcher Lid
- J** 72 oz. Total Crushing® Blender Pitcher**
- K** Stacked Blade Assembly
- L** Cleaning Brush
- M** Spaghetti Blade Disc
- N** Angel Hair Blade Disc
- O** Ribbon Blade Disc
- P** Pappardelle Blade Disc
- Q** Fettuccine Blade Disc
- R** Storage Box
- S** Food Pusher
- T** Feed Chute Lid
- U** Collecting Bowl
- V** Spiralizer Bowl

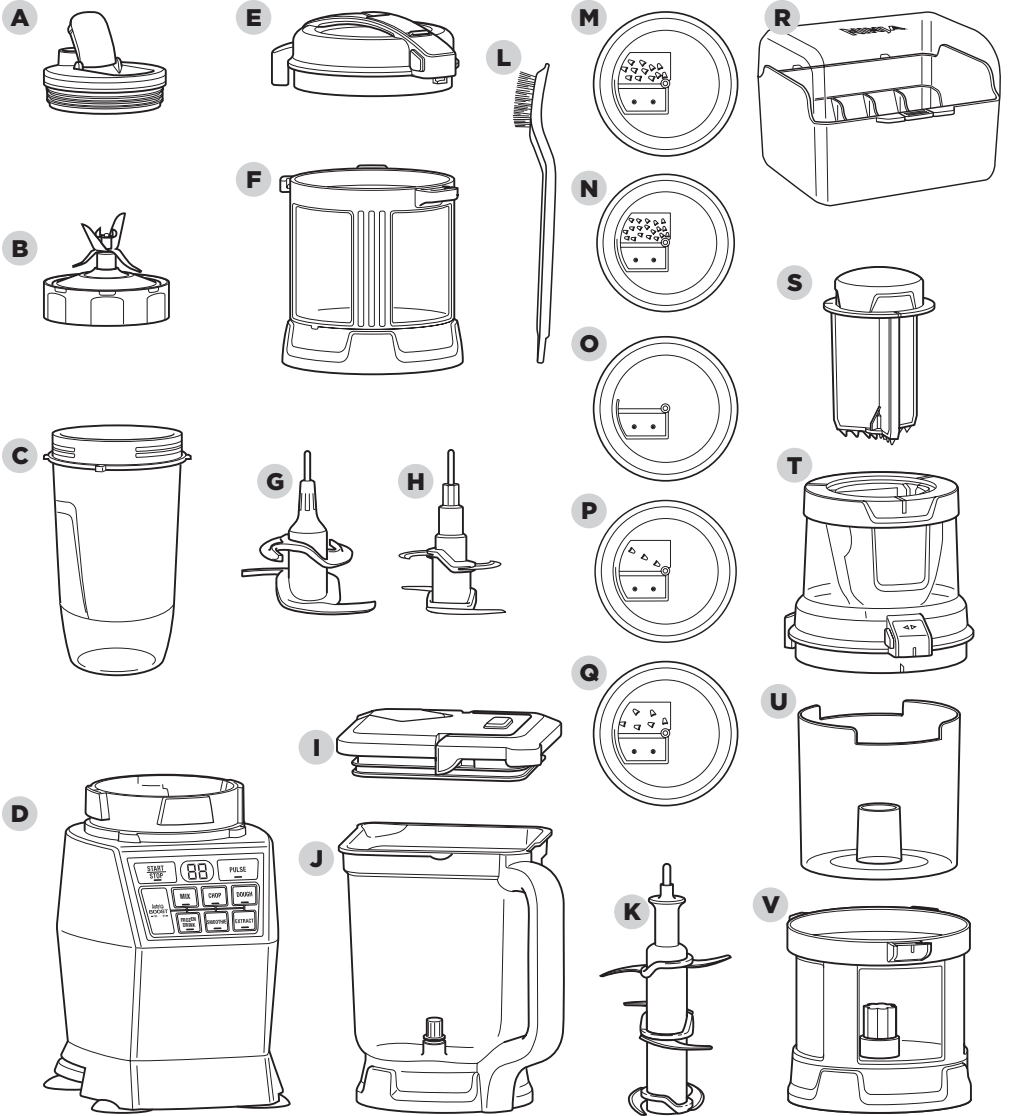

FEATURES

★ **IMPORTANT:** Review all warnings on pages 3–6 before proceeding.

DID YOU KNOW?

- You can take your drinks on the go using the Spout Lids.
- All containers, blade assemblies, Blade Discs, and lids are BPA free.
- Our blades, containers and lids are all dishwasher safe.

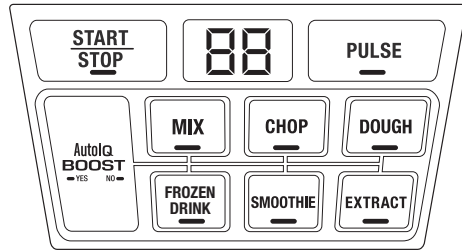

START | STOP

Press once to start running continuously, press again to stop. Timer counts up to 60 seconds. This button can be pressed at any time if you wish to stop the program.

PULSE

Offers greater control of pulsing and blending. Operates only when the PULSE button is pressed. Press and release quickly for short pulses.

Auto-iQ BOOST™

Control the consistency of your recipe by selecting BOOST YES or NO prior to selecting your Auto-iQ® program. The BOOST button toggles between YES and NO: select BOOST YES for smoother, creamier results; select BOOST NO for more texture.

Auto-iQ FROZEN DRINK

Takes all the guesswork out of turning ice, juices, and fruit into expertly blended frozen drinks.

Auto-iQ SMOOTHIE

Great for creamy, super-smooth drinks made from frozen fruit, ice, or dairy products.

Auto-iQ EXTRACT

Ideal for hard, leafy, or fibrous whole fruits and vegetables, including their skins, seeds, and stems.

Auto-iQ MIX

Delivers the perfect speed and blending time for Precision Processor™ Bowl creations including smoothie bowls, savory bowls, dips, and sauces.

Auto-iQ CHOP

Features timed pulses and pauses to give you consistent chopping results for a range of recipes, including ingredient prep, salsas, and ground meat.

Auto-iQ DOUGH

Takes all the guesswork out of creating perfect dough for bread, pizza, and decadent desserts.

BEFORE FIRST USE

- 1** Remove all packaging materials from the appliance. Exercise care when unpacking blade assemblies and Blade Discs. All blade assemblies and Blade Discs are sharp.
- 2** The Chopping Blade Assembly and Stacked Blade Assembly are NOT locked in place in their containers. Handle the Chopping Blade Assembly and Stacked Blade Assembly by grasping the top of the shaft.
- 3** Handle the Pro Extractor Blades® Assembly by grasping around the perimeter of the blade assembly base.
- 4** Wash containers, lids, Blade Discs, and blade assemblies in warm, soapy, water using a dishwashing utensil with a handle or the provided cleaning brush to avoid direct contact with the blades. Exercise care when handling blade assemblies, as the blades are sharp.
- 5** Thoroughly rinse and air-dry all parts.
- 6** All attachments are dishwasher safe. It is recommended that the lids, Blade Discs, and blade assemblies be placed on the top rack of the dishwasher. Ensure blade assemblies and Blade Discs are removed from their containers before placing in the dishwasher. Exercise care when handling blade assemblies or Blade Discs.
- 7** Wipe the motor base with a clean, damp cloth.

USING YOUR HIGH-SPEED BLENDER CUP

★ **IMPORTANT:** Review all warnings on pages 3–6 before proceeding.

.....

💡 **TIP:** For recommended filling instructions, see note on page 29.

NOTE: Auto-iQ® programs have pauses and changes in speed throughout the cycle.

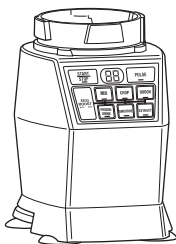

- 1** Place the unplugged motor base on a clean, dry, and level surface such as a countertop or table. Press downward on the motor base to adhere the suction cups to the work surface. Ensure the motor base is connected to power.
- 2** Add ingredients to the High-Speed Blender cup. DO NOT add ingredients past the Max Liquid line on the cup.



3 Install the Pro Extractor Blades® Assembly onto the top of the cup. Twist the lid clockwise until it's sealed tightly.

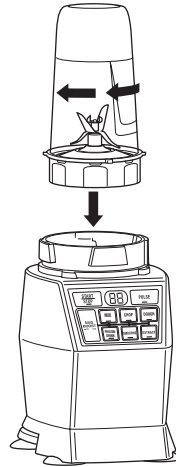

4 Turn the High-Speed Blender cup upside down and install onto the motor base. Align the tabs on the cup with the slots on the base, then twist until you hear a click. When the unit is connected to power and the container is correctly locked on to the motor base, the program buttons will illuminate and the unit will be ready for use.

USING YOUR HIGH-SPEED BLENDER CUP - CONT.

★ **IMPORTANT:** Review all warnings on pages 3–6 before proceeding.

.....

NOTE: Auto-iQ® Technology can sense which container is on the motor base. The available function lights will illuminate depending on which container is placed on the motor base. Not all function lights will be available for every container.

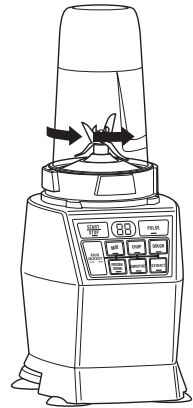

- 5** Press START/STOP to run continuously for 60 seconds. If using an Auto-iQ program, first select BOOST YES or BOOST NO, then the Auto-iQ program that best suits your recipe. The Auto-iQ feature will automatically stop the appliance at the end of the program. To pause the appliance at any time, press the currently active button a second time. Reference page 9 for program descriptions.
- 6** To remove the cup from the motor base, turn the cup counterclockwise and then lift it.



7 Remove the Pro Extractor Blades[®] Assembly by twisting the cap counter-clockwise. Do not store blended contents with Pro Extractor Blades Assembly attached. Exercise care when handling the blade assembly, as the blades are sharp.

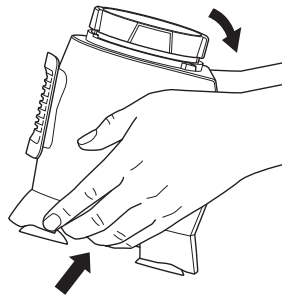

8 Unplug the appliance when finished. To release the motor base, place your hands underneath both sides of the motor base and gently pull the unit up and towards you. Refer to page 30 for storing instructions.



9 To enjoy your drink on the go, place the Spout Lid onto the High-Speed Blender cup and twist clockwise until firmly sealed. For storing ingredients in the cup, use only the Spout Lid to cover.

USING YOUR PRECISION PROCESSOR™ BOWL

★ **IMPORTANT:** Review all warnings on pages 3–6 before proceeding.

💡 **TIP:** Select BOOST YES for the smoothest, creamiest results—ideal for creamy dips like hummus. Select BOOST NO when a chunkier texture is desired—perfect for dishes like spinach & artichoke dip.

💡 **TIP:** If the blade assembly is not fully seated, you will not be able to install and lock the lid into position.

💡 **TIP:** To learn more about the unit's programs, check out page 9.

NOTE: Auto-iQ® programs have pauses and changes in speed throughout the cycle.

NOTE: DO NOT add ingredients before installing the blade assembly.

NOTE: For best results, follow recipe loading instructions.

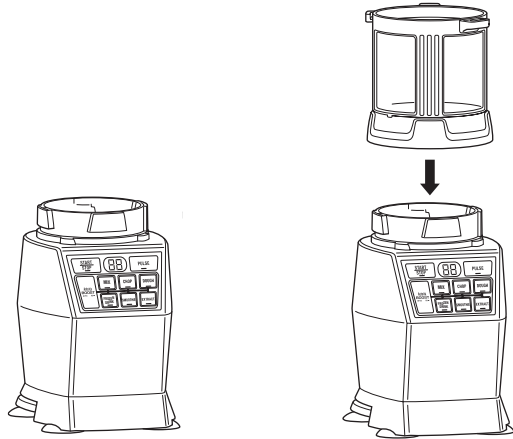

- 1** Place the unplugged motor base on a clean, dry, and level surface such as a countertop or table. Press downward on the motor base to adhere the suction cups to the work surface. Ensure the motor base is connected to power.
- 2** Lower the Precision Processor bowl onto the motor base.

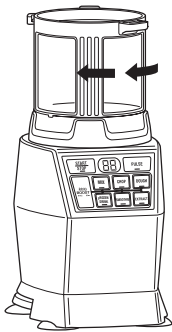

3 Rotate Precision Processor™ bowl clockwise until you hear a click.

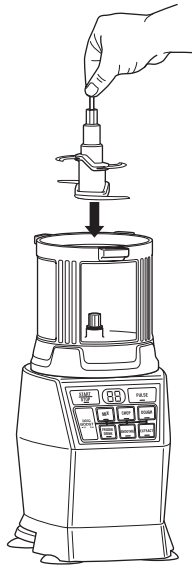

4 Exercising care, grasp the Chopping Blade Assembly by the top of the shaft and place it onto the drive gear inside the bowl. Note that the Chopping Blade Assembly will fit loosely onto the drive gear.

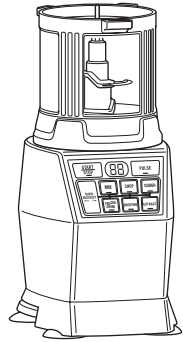

5 Add ingredients to the bowl, making sure not to exceed the Max Liquid and max fill lines.

USING YOUR PRECISION PROCESSOR™ BOWL - CONT.

★ **IMPORTANT:** Review all warnings on pages 3–6 before proceeding.

.....

NOTE: Please follow the same instructions for the Dough Blade Assembly.

NOTE: Auto-iQ® Technology can sense which container is on the motor base. The available function lights will illuminate depending on which container is placed on the motor base. Not all function lights will be available for every container.

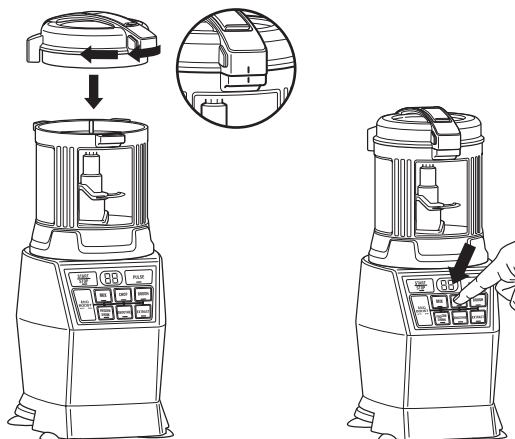

- 6** Place lid on Precision Processor Bowl, with black line on tab aligned slightly to the right of tab on front of bowl. Turn lid clockwise to lock in place. When properly locked, the white line on lid will line up with the black line on bowl. When the unit is connected to power and the container is correctly locked into the motor base, the program buttons will illuminate and the unit will be ready for use.
- 7** Press START/STOP to run continuously for 60 seconds. If using an Auto-iQ program, first select BOOST YES or BOOST NO, then the Auto-iQ program that best suits your recipe. The Auto-iQ feature will automatically stop the appliance at the end of the program. To pause the appliance at any time, press the currently active button a second time. Reference page 9 for program descriptions.

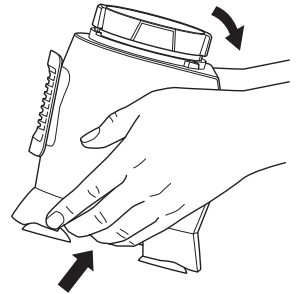
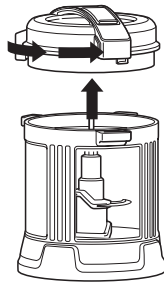
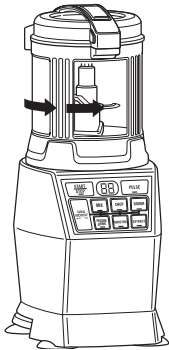

8 To remove the bowl from the motor base, turn the bowl counterclockwise and then lift it.

9 Remove the lid by pressing the release button on the front tab, twisting the lid counterclockwise, and lifting up. Always remove the Chopping Blade Assembly before emptying any of the ingredients in the bowl. To remove the Chopping Blade Assembly, carefully grasp it by the top of the shaft and lift it out of the bowl.

10 Unplug the appliance when finished. To release the motor base, place your hands underneath both sides of the motor base and gently pull the unit up and towards you. Refer to page 30 for storing instructions.

ASSEMBLING YOUR AUTO-SPIRALIZER™

★ **IMPORTANT:** Review all warnings on pages 3–6 before proceeding.

.....

★ **IMPORTANT:** As a safety feature, if the Spiralizer Bowl and Feed Chute Lid are not properly installed, the timer will display "--" and the motor will be disabled.

NOTE: To fit properly, the tabs on the sides of the Blade Disc must align with the gaps on the top of the Collecting Bowl.

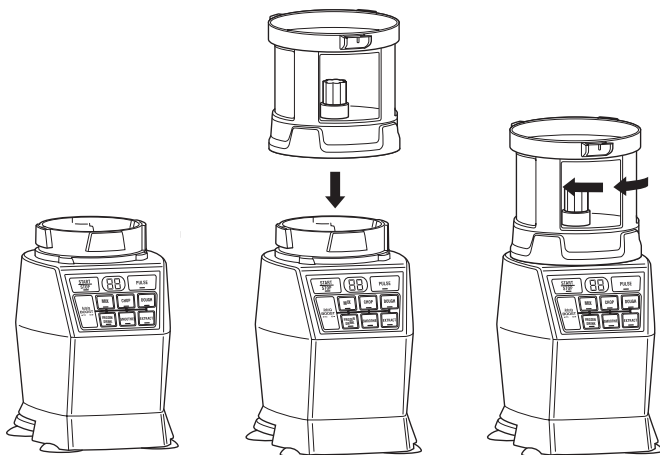

- 1** Place the unplugged motor base on a clean, dry, and level surface such as a countertop or table. Press downward on the motor to adhere the suction cups to the work surface. Ensure the motor base is connected to power.
- 2** Lower the Spiralizer Bowl onto the motor base.
- 3** Rotate the Spiralizer Bowl clockwise until it clicks into place.

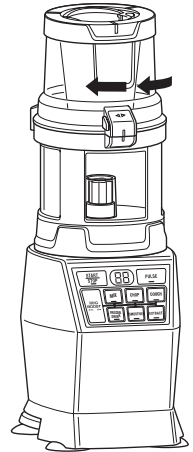
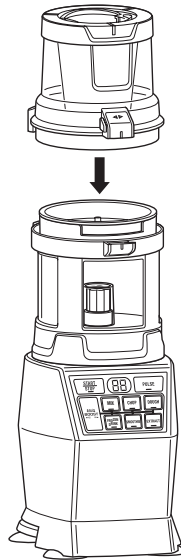
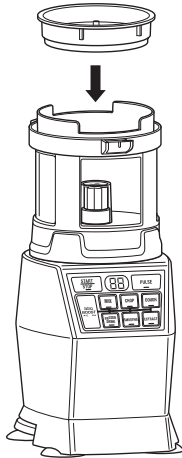
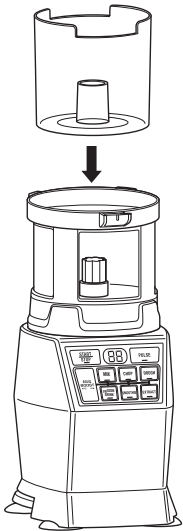

- 4** Place the Collecting Bowl inside the Spiralizer Bowl, aligning it over the gear post.
- 5** Choose your Blade Disc, making sure to handle it carefully.
- 6** Install the Blade Disc onto the top of the Collecting Bowl. The rim of the Blade Disc should sit flush against the top of the bowl, and the tabs on the sides of the Blade Discs must align with the slots on the top of the Collecting Bowl.
- 7** Assemble the Feed Chute Lid on top of the Spiralizer Bowl. Turn the lid clockwise onto the Spiralizer Bowl, aligning the gray tabs on the lid with the front of the bowl. When the unit is connected to power and the container is correctly assembled onto the motor base, the START/STOP button will illuminate, indicating that the unit is ready for use.

USING YOUR AUTO-SPIRALIZER™

★ **IMPORTANT:** Review all warnings on pages 3–6 before proceeding.

.....

★ **IMPORTANT:** After Spiralizing an ingredient, all leftover pieces must be removed from the Collecting Bowl and Blade Disc before Spiralizing again.

NOTE: To find out how to properly prep your ingredient, refer to the Food Prep section in your Quick Start Guide or your Inspiration Guide.

NOTE: Never Spiralize multiple ingredients at one time.

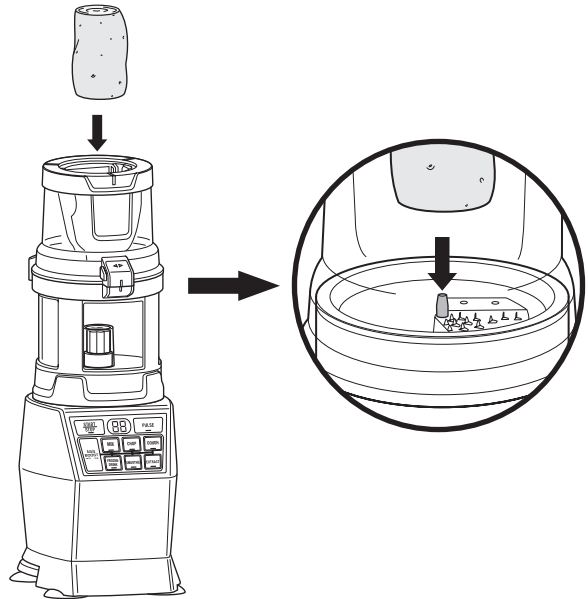

- 1** Before spiralizing, prepare your ingredient by cutting it so that it is no more than 3 inches wide. Place the prepped ingredient into the Feed Chute, through the opening at the top.
- 2** Center the ingredient on the pin in the center of the Blade Disc, then push down, securing the ingredient onto the pin.

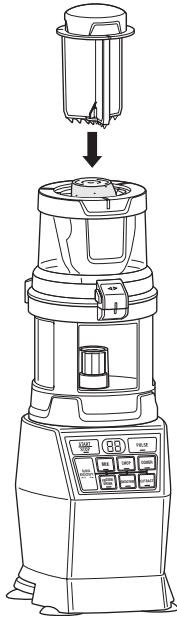

3 Place the Food Pusher on top of the ingredient and press down firmly to hold in place.

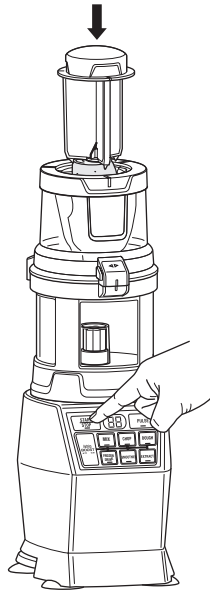

4 Select START/STOP to begin Spiralizing. Continue to press firmly with Food Pusher to guide ingredient through Feed Chute.



5 Spiralizing is complete when the Food Pusher sits flat atop the Feed Chute Lid. Press START/STOP to power off the motor.

USING YOUR AUTO-SPIRALIZER™ - CONT.

★ **IMPORTANT:** Review all warnings on pages 3–6 before proceeding.

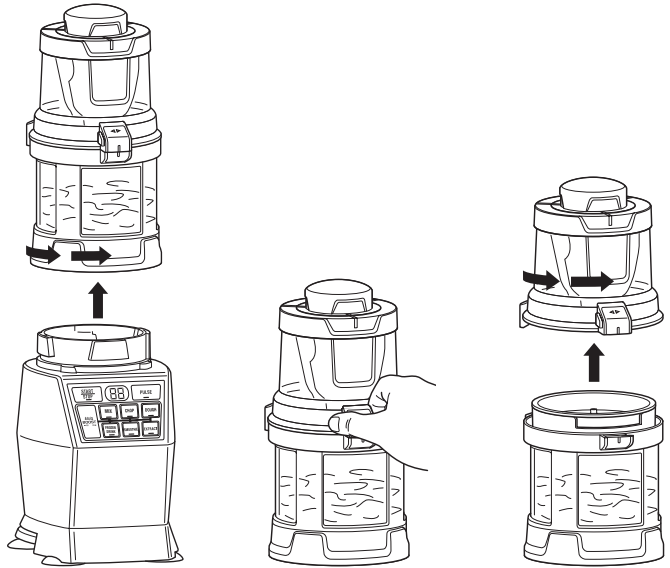

6 To remove the Spiralizer Bowl from the motor base, turn the bowl counterclockwise and lift up.

7 To remove the Feed Chute Lid, press the release button on the left side of the front tab, then twist the lid counterclockwise and lift up.

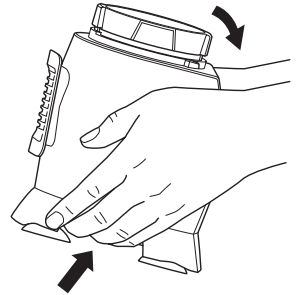
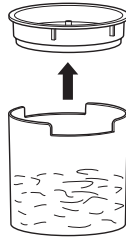
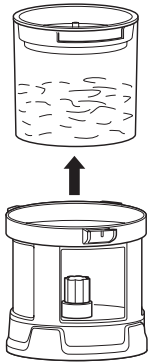

8 Remove the Collecting Bowl by lifting it up and out of the Spiralizer Bowl. Remove the Blade Disc by gripping the handles on the side of the disc and lifting up.

9 Remove the noodles from the Collecting Bowl and prepare as desired.

10 Unplug the appliance when finished. To release the motor base, place your hands underneath it and gently pull it toward you. Refer to page 30 for storing instructions.

USING YOUR TOTAL CRUSHING® BLENDER PITCHER

★ **IMPORTANT:** Review all warnings on pages 3–6 before proceeding.

💡 **TIP:** If the Stacked Blade Assembly is not fully seated, you will not be able to install and lock the lid into position.

💡 **TIP:** To learn more about the unit's programs, check out page 9.

NOTE: Auto-iQ® programs have pauses and changes in speed throughout the cycle.

NOTE: DO NOT add ingredients before completing installation of the Stacked Blade Assembly.

NOTE: The pitcher can only be installed in one orientation. The handle must be positioned on the front-right corner of the motor base to operate the appliance.

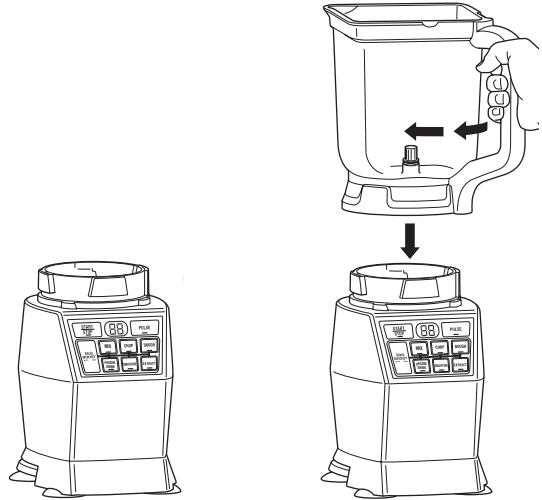

- 1** Plug in motor base and place on a clean, dry, level surface such as a countertop or table. Press downward on the motor base to adhere the suction cups to the work surface.
- 2** Lower the Total Crushing Blender pitcher onto the motor base. The handle should be aligned slightly to the right and the pitcher should be oriented so the LOCK symbols are visible on the motor base. Then rotate the pitcher clockwise until you hear a click.

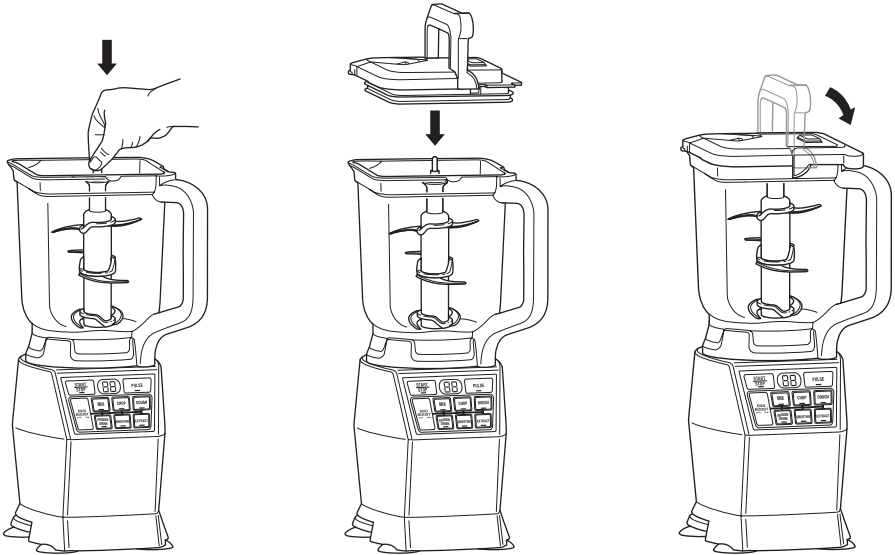

- 3** Exercising care, grasp the Stacked Blade Assembly by the top of the shaft and place it onto the drive gear inside the pitcher. Note that the blade assembly will fit loosely onto the drive gear.
- 4** Add ingredients to the pitcher, making sure not to exceed the Max Liquid line on the side of the pitcher. When blending liquids, such as beverages or smoothies, **DO NOT** exceed the Max Liquid line on the side of the pitcher.
- 5** Place the lid on the pitcher, aligning the triangle symbol located on the lid with the triangle symbol located on the pitcher's handle. Press down on the handle until you hear a click. The triangle symbols **MUST** be aligned for the lid to lock into place and the appliance to operate. When the unit is connected to power and the container is correctly locked into the motor base, the program buttons will illuminate and the unit will be ready for use.

USING YOUR TOTAL CRUSHING® BLENDER PITCHER - CONT.

★ **IMPORTANT:** Review all warnings on pages 3–6 before proceeding.

★ **IMPORTANT:** As a safety feature, if the pitcher and lid are not properly installed, the timer will display "--" and the motor will be disabled. If this happens, repeat step 5 on page 26. When the pitcher and lid are properly installed, the program buttons will illuminate steadily, indicating the appliance is ready for use.

💡 **TIP:** The BOOST button toggles between YES and NO: select BOOST YES for smoother, creamier results; select BOOST NO for more texture.

NOTE: Auto-iQ® Technology can sense which container is on the motor base. The available function lights will illuminate depending on which container is placed on the motor base. Not all function lights will be available for every container.

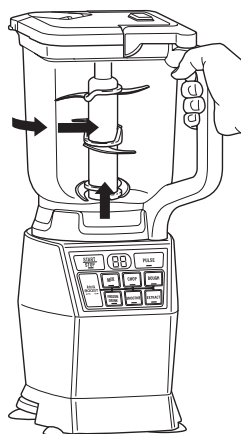
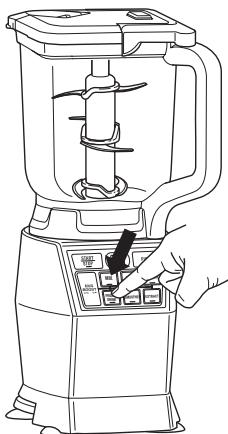

- 6 Press START/STOP to run continuously for 60 seconds. If using an Auto-iQ program, first select BOOST YES or BOOST NO, then the Auto-iQ program that best suits your recipe. The Auto-iQ feature will automatically stop the appliance at the end of the program. To pause the appliance at any time, press the currently active button a second time. Reference page 9 for program descriptions.
- 7 If not using Auto-iQ and ingredients have reached your desired consistency, stop the appliance by pressing the START/STOP button, and wait for the appliance to come to a complete stop.
- 8 To remove the pitcher from the motor base, turn the pitcher counterclockwise and then lift it.

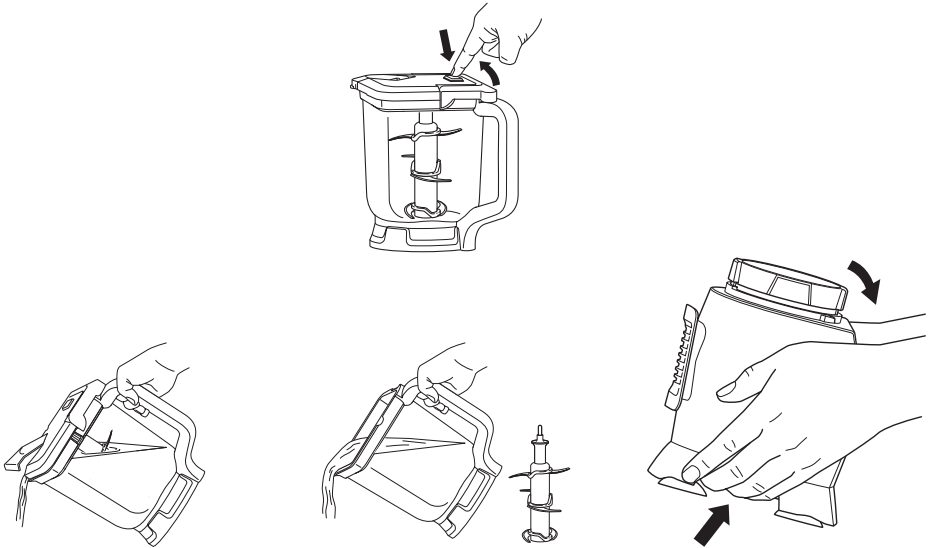

9 To pour out thinner mixtures, ensure that the lid is locked in place, then open the pour spout cap.

10 For thicker mixtures that cannot be emptied through the pour spout, remove the lid and Stacked Blade Assembly before pouring. To remove the lid, press the RELEASE button and lift the handle. To remove the blade assembly, carefully grasp it by the top of the shaft. The pitcher can then be emptied.

11 Unplug the appliance when finished. To release the motor base, place your hands underneath both sides of the motor base and gently pull the unit up and towards you. Refer to page 30 for storing instructions.

SUGGESTED USES & FILLING INSTRUCTIONS

★ **IMPORTANT:** Review all warnings on pages 3–6 before proceeding.

.....

ORDERING REPLACEMENT PARTS

To order additional parts and attachments, please visit ninjaccessories.com or contact customer service at 1-877-646-5288.

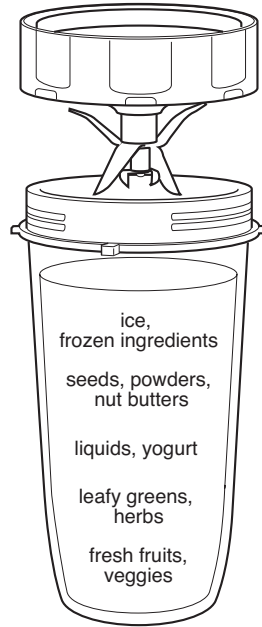

FILLING YOUR HIGH-SPEED BLENDER CUP

For best results, always follow recipe directions when filling your High-Speed Blender cup. When you're not using a recipe, use the following guidelines:

Start with fresh fruit or veggies (for best results, cut ingredients in 1-inch chunks). Next add leafy greens or herbs, followed by any liquids like water, juice, milk, or yogurt. Then add seeds, powders or nut butters. Lastly, add ice or frozen ingredients. Remember to securely tighten the Pro Extractor Blades® Assembly and don't overfill the cup.

CARE & MAINTENANCE

CLEANING

- 1 Separate all parts.
- 2 Wash all containers in warm, soapy water with a soft cloth.

3 Hand Washing

Wash blade assemblies and Blade Discs in warm, soapy water using a dishwashing utensil with a handle or the provided cleaning brush to avoid direct contact with the blades. Exercise care when handling blade assemblies as the blades are sharp. Thoroughly rinse and air-dry all parts.

Dishwasher

All attachments are dishwasher safe. It is recommended that the lids, containers, Blade Discs, and blade assemblies be placed on the top rack of the dishwasher ONLY. Ensure that blade assemblies are removed from their containers before placing in the dishwasher. Exercise care when handling blade assemblies.

- 4 Wipe the motor base with a clean, damp cloth. Allow time to dry before operation.

STORING

Wrap the power cord around the cord wrap on the back of the motor base. Store the unit upright and store all blade assemblies inside or attached to their respective containers with their lids locked into place. Store the blade discs in the storage box.

DO NOT store blended or unblended ingredients in the High-Speed Blender cup with the Pro Extractor Blades® assembly attached.

DO NOT stack items on top of the containers. Store any remaining attachments alongside the appliance or in a cabinet where they will not be damaged or create a hazard.

RESETTING THE MOTOR THERMOSTAT

This appliance features a unique safety system that prevents damage to the motor and drive system should you inadvertently overload the appliance. If the appliance is overloaded, the motor will be temporarily disabled. Should this occur, follow the reset procedure below.

- 1 Unplug the appliance from the electrical outlet.
- 2 Allow the appliance to cool for approximately 15 minutes.
- 3 Remove the container lid and blade assembly. Empty the container and ensure no ingredients were jamming the blade assemblies.
- 4 Reset the unit in accordance with the applicable instructions for the container and blade type.

IMPORTANT: Ensure that maximum capacities are not exceeded. This is the most typical cause of appliance overload.

If your unit needs servicing, please call Customer Service at 1-877-646-5288.

TROUBLESHOOTING GUIDE

⚠ WARNING: To reduce the risk of shock and unintended operation, turn power off and unplug unit before troubleshooting.

Unit doesn't turn on.

- Make sure unit is plugged in.
- Display will read "--" once connected to power.
- Insert and rotate container clockwise in base until it clicks. Programs will illuminate indicating that your blender is ready for use.

Unit doesn't turn off.

- Remove container from base by rotating it counterclockwise and lifting it up. Display should turn off. Unplug the power cord from the outlet.

Lid/Pro Extractor Blades® Assembly is hard to assemble.

- Set the cup on a level surface. Carefully place the lid or Pro Extractor Blades Assembly on the top of the cup and align the threads so the lid/Pro Extractor Blades Assembly sits flat on the cup. Twist clockwise until you have a tight seal.

Food is not evenly chopped.

- For best results when chopping, cut pieces down to even sizes and do not overfill the Precision Processor™ bowl.

Doesn't mix well; ingredients get stuck.

- Using the Auto-iQ® programs is the easiest way to achieve great results. The pulses and pauses allow the ingredients to settle toward the Pro Extractor Blades Assembly. If ingredients are routinely getting stuck, adding some liquid will usually help.
- When filling the cup, start with fresh fruit or veggies, then leafy greens or herbs. Next add liquids or yogurt, then seeds, powders, or nut butters. Finally, add ice or frozen ingredients.

Motor base won't stick to counter or tabletop.

- Make sure surface and suction feet are wiped clean. Suction feet will only stick to smooth surfaces.
- Suction feet WILL NOT stick on some surfaces such as wood, tile, and non-polished finishes.
- DO NOT attempt to use appliance when the motor base is stuck to a surface that is not secure (cutting board, platter, plates, etc.).

Unit is difficult to remove from counter for storage.

- Place your hands underneath both sides of the motor base and gently pull the unit up and towards you.

You get a blinking “- -” Message

- Auto-iQ Technology can detect which container is on the motor base. You may be trying to use a program that is not designed for the container you have installed. The programs will light up indicating which programs are available for each container.

You cannot create snow from solid ice.

- Do not use ice that has been sitting out or has started to melt. Use ice straight from the freezer.
- Start with a few pulses and then go to a continuous blending cycle.

You get semi-circular or shredded noodles.

- If the Collecting Bowl is overfilled, causing the Blade Disc to lift up after Spiralizing, your ingredient may have been too large. Make sure to trim and prepare your ingredients properly before Spiralizing by following the instructions in the Food Prep section in your Quick Start Guide or Inspiration Guide.
- For the most consistent results, be sure to center the ingredient onto the pin located in the center of the Blade Disc. (Refer to page 21, step 2).

Ingredient is not fully processed and is spinning on the pusher.

- Remove remaining ingredient from Blade Disc pin and trim top and bottom so that both are flat. Make sure you center ingredient on the Blade Disc pin and secure the Food Pusher firmly on top of the ingredient. While maintaining pressure on food pusher, press the START/STOP button.

Shark | NINJA ONE (1) YEAR LIMITED WARRANTY

The 1-Year Limited Warranty applies to purchases made from authorized retailers of SharkNinja Operating LLC. Warranty coverage applies to the original owner and to the original product only and is not transferable.

SharkNinja warrants that the unit shall be free from defects in material and workmanship for a period of 1 year from the date of purchase when it is used under normal household conditions and maintained according to the requirements outlined in this Instruction manual, subject to the following conditions and exclusions.

What is covered by my warranty?

1. The original unit and/or non-wearable components deemed defective, in SharkNinja's sole discretion, will be repaired or replaced for up to 1 year from the original purchase date.
2. In the rare event that a replacement unit is issued, the warranty coverage ends six months after the receipt date of the replacement unit or the remainder of the existing warranty, whichever is greater. If the unit is replaced, SharkNinja reserves the right to replace the unit with one of equal or greater value.

What is not covered by my warranty?

Our Customer Service and Product Specialists are available to provide all the warranty service options available to you, including the possibility of upgrading to our VIP Warranty Service Options for select product categories.

1. Normal wear and tear of wearable parts (including all blending vessels, lids, blades and blender base) which require regular maintenance and/or replacement to ensure the proper functioning of your unit are not covered by this warranty.
2. Any unit that has been tampered with or used for commercial purposes.
3. SharkNinja will cover the cost for the customer to send the unit to us for repair or replacement. A fee of \$19.95 for return shipping costs will be charged at the time of return shipment of the repaired or replacement unit.
4. Damage caused by misuse, abuse, or negligent handling, or damage due to mishandling in transit.
5. Consequential and incidental damages.
6. Defects caused by or resulting from damages from shipping or from repairs, service, or alteration to the product or any of its parts which have been performed by a repair person not authorized by SharkNinja.
7. Products purchased, used or operated outside of North America.

Problems with your unit/How to get service:

If your appliance fails to operate properly while in use under normal household conditions within the warranty period, visit ninjakitchen.com for product care/maintenance self-help. Our Customer Service and Product Specialists are also available at 1-877-646-5288 to assist with product support and warranty service options.

How to initiate a warranty claim:

You can call 1-877-646-5288 to have a Customer Service specialist assist you. Please note, you must call 1-877-646-5288 to initiate a warranty claim. Return and Packing Instruction information will be provided at that time.

For Customer Service hours, visit ninjakitchen.com.

Replacement parts are available for purchase at ninjakitchen.com. For more information on what is classified as wearable and non-wearable parts, please visit ninjakitchen.com/warranty.

This warranty gives you specific legal rights, and you may also have other rights that vary from state to state.

Some states do not permit the exclusion or limitation of incidental or consequential damages, so the above may not apply to you.



SharkNinja Operating LLC
US: Needham, MA 02494
CAN: Ville St-Laurent, QC H4S 1A7
1-877-646-5288
ninjakitchen.com

Illustrations may differ from actual product. We are constantly striving to improve our products; therefore the specifications contained herein are subject to change without notice.

AUTO-IQ, NINJA, PRO EXTRACTOR BLADES, and TOTAL CRUSHING are registered trademarks of SharkNinja Operating LLC.

4-IN-1 KITCHEN SYSTEM, AUTO-IQ BOOST, AUTO-SPIRALIZER, and PRECISION PROCESSOR are trademarks of SharkNinja Operating LLC.

For SharkNinja U.S. Patent information, visit sharkninja.com/USPatents.

© 2017 SharkNinja Operating LLC
NN210Q_IB_170711
PRINTED IN CHINA



@ninjakitchen