

NINJA®

OP401

OWNER'S GUIDE

FOODI® DELUXE TENDERCRISP™ PRESSURE COOKER



THANK YOU

for purchasing the Ninja® Foodi® Deluxe TenderCrisp™ Pressure Cooker



REGISTER YOUR PURCHASE

 registeryourninja.com

 Scan QR code using mobile device

RECORD THIS INFORMATION

Model Number: _____

Serial Number: _____

Date of Purchase: _____
(Keep receipt)

Store of Purchase: _____

TECHNICAL SPECIFICATIONS

Voltage: 120V~, 60Hz

Watts: 1760W

TIP: You can find the model and serial numbers on the QR code label located on the back of the unit by the power cord.

CONTENTS

Important Safeguards	2
Parts & Accessories	6
Using the Control Panel	8
Function Buttons	8
Operating Buttons	8
Before First Use	9
Installing the Condensation Collector	9
Removing & Reinstalling the Anti-Clog Cap	9
Using Your Foodi® Deluxe TenderCrisp™ Pressure Cooker ..	10
Swap the Top	10
Using the Crisping Lid	10
Using the Cooking Functions with the Crisping Lid	10
Air Crisp	10
Bake/Roast	11
Broil	12
Dehydrate	13
Familiarizing Yourself With Pressure Cooking	14
Natural Pressure Release vs. Quick Pressure Release	15
Pressurizing	15
Installing & Removing the Pressure Lid	15
Using the Cooking Functions with the Pressure Lid	16
Pressure Cook	16
Steam	17
Slow Cook	18
Yogurt	18
Sear/Sauté	19
Accessories for Purchase	20
Cleaning & Maintenance	21
Cleaning: Dishwasher & Hand-Washing	21
Removing & Reinstalling the Silicone Ring	21
Troubleshooting Guide	22
Helpful Tips	24
Replacement Parts	24
Warranty	25

IMPORTANT SAFEGUARDS

HOUSEHOLD USE ONLY • READ ALL INSTRUCTIONS BEFORE USE

⚠ WARNING

- 1** This appliance can be used by persons with reduced physical, sensory or mental capabilities or lack of experience and knowledge if they have been given supervision or instruction concerning use of the appliance in a safe way and understand the hazards involve
- 2** Keep the appliance and its cord out of reach of children. **DO NOT** allow the appliance to be used by children. Close supervision is necessary when used near children.
- 3** To eliminate a choking hazard for young children, discard all packaging materials immediately upon unpacking.
- 4** **DO NOT** place appliance on a stovetop or hot surfaces or near gas or electric burner or in a heated oven.
- 5** **DO NOT** use the appliance without the removable cooking pot installed.
- 6** When removable cooking pot is empty, **DO NOT** heat it for more than 10 minutes, as doing so may damage the cooking surface.
- 7** Children shall not play with the appliance.
- 8** **NEVER** use electrical outlet below counter.
- 9** **NEVER** connect this appliance to an external timer switch or separate remote-control system.
- 10** **DO NOT** use an extension cord. A short power-supply cord is used to reduce the risk of children grabbing the cord or becoming entangled and to reduce the risk of people tripping over a longer cord.
- 11** To protect against electrical shock **DO NOT** immerse cord, plugs, or main unit housing in water or other liquid. Cook only in the pot provided or in a container recommended by SharkNinja placed in the provided pot.
- 12** Regularly inspect the appliance and power cord. **DO NOT** use the appliance if there is damage to the power cord or plug. If the appliance malfunctions or has been damaged in any way, immediately stop use and call Customer Service.
- 13** **ALWAYS** ensure the appliance is properly assembled before use.
- 14** Before use, **ALWAYS** check pressure release valve and float valve for clogging or obstruction and clean them if necessary. Check to make sure the float valve on the pressure lid moves freely. Foods such as apple sauce, cranberries, pearl barley, oatmeal or other cereals, split peas, noodles, macaroni, rhubarb, or spaghetti can foam, froth, and splutter when pressure cooked, clogging the pressure release valve. These and similar expanding foods (such as dried vegetables, beans, grains, and rice) should not be cooked in a pressure cooker, except when following a Ninja Foodi recipe.
- 15** **DO NOT** cover the air intake vent, air exhaust vent or electrical outlet while crisping lid is closed. Doing so will prevent even cooking and may damage the unit or cause it to overheat.
- 16** To prevent risk of explosion and injury, use only SharkNinja silicone rings. Make certain silicone ring is installed and lid is properly closed before operating. **DO NOT** use if torn or damaged. Replace silicone ring before using.
- 17** Before placing removable cooking pot into the cooker base, ensure pot and cooker base are clean and dry by wiping with a soft cloth.
- 18** This appliance is for household use only. **DO NOT** use this appliance for anything other than its intended use. **DO NOT** use in moving vehicles or boats. **DO NOT** use outdoors. Misuse may cause injury.
- 19** Intended for worktop use only. Ensure the surface is level, clean and dry. **DO NOT** move the appliance when in use.
- 20** **DO NOT** use accessory attachments not recommended or sold by SharkNinja. **DO NOT** place accessories in a microwave, toaster oven, convection oven, or conventional oven or on a ceramic cooktop, electric coil, gas burner range, or outdoor grill. The use of accessory attachments not recommended by SharkNinja may cause fire, electric shock, or injuries.
- 21** When using this appliance, provide adequate space above and on all sides for air circulation.
- 22** **ALWAYS** follow the maximum and minimum quantities of liquid as stated in instructions and recipes.
- 23** **NEVER** use SLOW COOK setting without food and liquids in the removable cooking pot.
- 24** **DO NOT** use this appliance for deep frying.
- 25** **DO NOT** cover the pressure valves.
- 26** **DO NOT** sauté or fry with oil while pressure cooking.
- 27** Prevent food contact with heating elements. **DO NOT** overfill or exceed the MAX fill level of the pot and the Cook & Crisp Basket or Plate. Overfilling may cause personal injury or property damage or affect the safe use of the appliance.
- 28** When pressure cooking foods that expand (such as dried vegetables, beans, grains, rice, etc.). **DO NOT** fill pot more than halfway, or as otherwise instructed in a Ninja® Foodi® recipe.
- 29** **DO NOT** use this unit to cook instant rice.
- 30** Electrical outlet voltages can vary, affecting the performance of your product. To prevent possible illness, use a thermometer to check that your food is cooked to the temperatures recommended.
- 31** **DO NOT** place the appliance near the edge of a worktop during operation.
- 32** To avoid possible steam damage, place the unit away from walls and cabinets during use.
- 33** Should the unit emit black smoke, unplug immediately and wait for smoking to stop before removing the cooking pot and Cook & Crisp™ Basket or Plate.
- 34** **DO NOT** touch hot surfaces. Appliance surfaces are hot during and after operation. To prevent burns or personal injury, **ALWAYS** use protective hot pads or insulated oven mitts and use available handles and knobs.
- 35** Extreme caution must be used when the cooker contains hot food or hot liquids and/or if the cooker is under pressure. Improper use, including moving the cooker, may result in personal injury such as serious burns. When using this appliance to pressure cook, ensure the lid is properly assembled and locked into position before use. Food are under extreme pressure during pressure cooking. Failure to follow all instructions regarding proper usage of the product may result in unintended contact with hot foods or liquids that have been pressurized, resulting in serious burns.

SAVE THESE INSTRUCTIONS

IMPORTANT SAFEGUARDS

HOUSEHOLD USE ONLY • READ ALL INSTRUCTIONS BEFORE USE

- 36** Caution should be used when searing meats and sautéing. Keep hands and face away from the removable cooking pot, especially when adding new ingredients, as hot oil may splatter.
- 37** When unit is in operation, hot steam is released through the air exhaust vent. Place unit so vent is not directed toward the power cord, electrical outlets, cabinets or other appliances. Keep your hands and face at a safe distance from vent.
- 38** **DO NOT** tamper with, disassemble, or otherwise remove the float valve or pressure release assembly.
- 39** **DO NOT** attempt to open the lid during or after pressure cooking until all internal pressure has been released through the pressure release valve and the unit has cooled slightly. Remove lid promptly to avoid re-pressurization of the inner pot.
- 40** **DO NOT** use Pressure Lid when Sear/Sauté function is selected.
- 41** If using SLOW COOK setting, **ALWAYS** keep the pressure lid closed and the pressure release valve in the VENT position. If the lid is closed and the pressure release valve is in the SEAL position, an audible alarm will sound. "VENT" error code will appear on LED display to signal the need to turn the pressure release valve to the VENT position.
- 42** When using the PRESSURE COOK setting, **ALWAYS** keep the pressure lid locked and the pressure release valve turned anticlockwise to the SEAL position.
- 43** If the lid will not turn to unlock, this indicates the appliance is still under pressure. **DO NOT** intentionally press down on float valve. Any pressure remaining can be hazardous. Let unit naturally release pressure or turn the Pressure Release Valve slowly to the VENT position to release steam. Take care to avoid contact with the releasing steam to avoid burns or injury. When steam is completely released the float valve will be in the lower position allowing the lid to be removed. If steam does not release when the pressure release valve is moved to vent, unplug the unit from the wall and let the unit naturally release pressure.
- 44** Spilled food can cause serious burns. Keep appliance and cord away from children. **DO NOT** let cord hang over edge of tables or counters or touch hot surfaces.
- 45** Serious burns can result from the steam and hot foods inside the inner pot. **ALWAYS** keep hands, face, and other body parts away from the pressure release valve prior to or during pressure release and when removing the pressure lid after cooking.
- 46** When removing the lid, **DO NOT** lift the lid straight up as this may not release the seal between the lid and pot, increasing the risk of food splashing.
- 47** **ALWAYS** tilt the lid so that it is between your body and the inner pot so that you can be shielded from steam and hot liquids.

- 48** The cooking pot, Cook & Crisp™ Basket or Plate, and reversible rack become extremely hot during the cooking process. Avoid hot steam and air while removing the cooking pot and Cook & Crisp™ Basket or Plate from the appliance, and **ALWAYS** place them on a heat resistant surface after removing. **DO NOT** touch accessories during or immediately after cooking.
- 49** Removable cooking pot can be extremely heavy when full of ingredients. Care should be taken when lifting pot from cooker base.
- 50** Cleaning and user maintenance shall not be made by children.
- 51** Let the appliance cool for approximately 30 minutes before handling, cleaning, or storing.
- 52** To disconnect, turn any control to OFF, then unplug from electrical outlet when not in use and before cleaning. Allow to cool before cleaning, disassembly, putting in or taking off parts and for storage
- 53** **DO NOT** clean with metal scouring pads. Pieces can break off the pad and touch electrical parts, creating a risk of electric shock.
- 54** Please refer to the Cleaning & Maintenance section for regular maintenance of the appliance.



Indicates to read and review instructions to understand operation and use of product.



Indicates the presence of a hazard that can cause personal injury, death or substantial property damage if the warning included with this symbol is ignored.



Take care to avoid contact with hot surface. Always use hand protection to avoid burns.



For indoor and household use only.

SAVE THESE INSTRUCTIONS

PARTS & ACCESSORIES

PARTS

- A** Reversible Rack
- B** Cook & Crisp™ Layered Insert
- C** Cook & Crisp Basket
- D** Detachable Diffuser
- E** 8-Quart Removable Cooking Pot
- F** Crisping Lid
- G** Heat Shield
- H** Control Panel
- I** Cooker Base
- J** Pressure Lid
- K** Pressure Release Valve
- L** Float Valve
- M** Silicone Ring
- N** Anti-Clog Cap
- O** Air Outlet Vent
- P** Condensation Collector

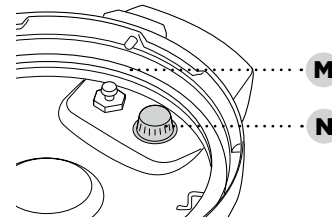
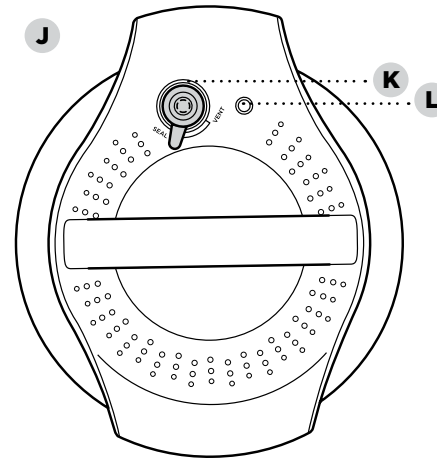
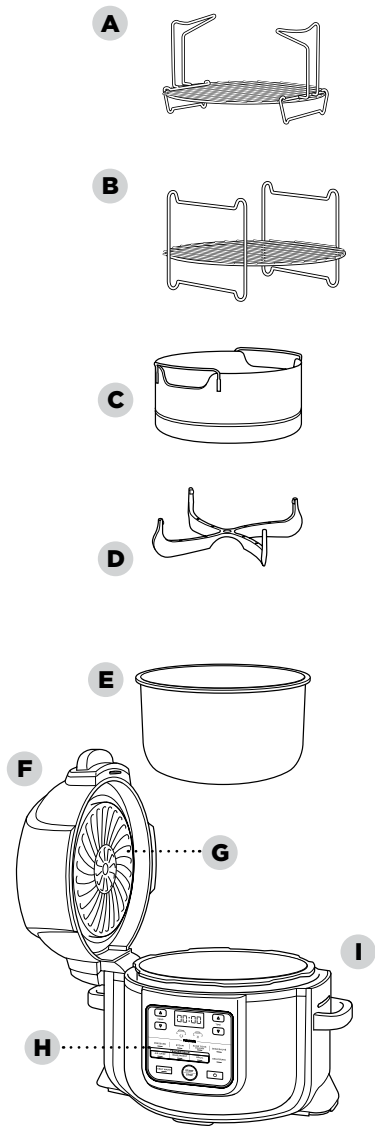

Underside of Pressure Lid

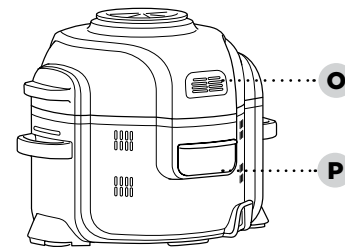

ACCESSORIES (SOLD SEPARATELY)

- Q** Skewer Stand
- R** Multi-Purpose Pan
- S** Roasting Rack Insert
- T** Dehydrating Rack
- U** Loaf Pan
- V** Crisper Pan

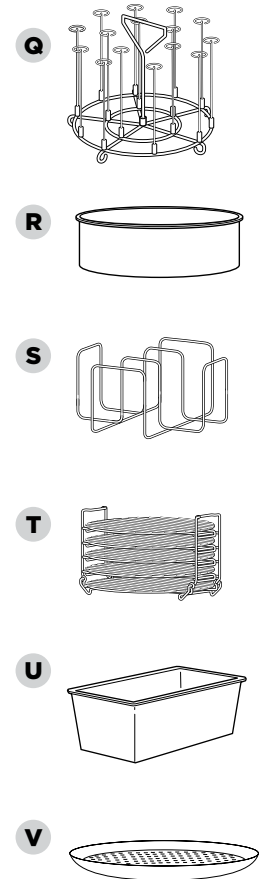

USING THE CONTROL PANEL

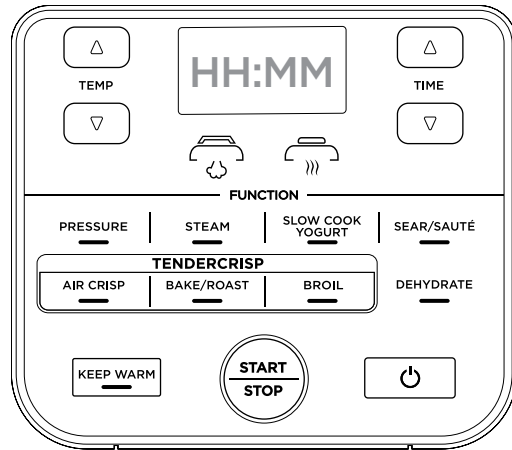

NOTE: Control panel may differ per model.

FUNCTION BUTTONS

PRESSURE: Use to cook food quickly while maintaining tenderness.

STEAM: Use to gently cook delicate foods at a high temperature.

SLOW COOK: Cook your food at a lower temperature for longer periods of time.

YOGURT: Pasteurize and ferment milk for creamy homemade yogurt.

SEAR/SAUTÉ: To use the unit as a stovetop for browning meats, sautéing veggies, simmering sauces, and more.

AIR CRISP: To use the unit as an air fryer to give foods crispiness and crunch with little to no oil.

BAKE/ROAST: To use the unit as an oven for tender meats, baked treats, and more.

BROIL: Use to caramelize and brown your food.

DEHYDRATE: Dehydrate meats, fruits, and vegetables for healthy snacks.

OPERATING BUTTONS

TEMP arrows: Use the up and down TEMP arrows to adjust the cook temperature and/or pressure level.

TIME arrows: Use the up and down TIME arrows to adjust the cook time.

NOTE: While cooking, to adjust temp or time, use the up and down arrows. The unit will then resume at those settings.

START/STOP button: Press the START/STOP button after selecting your temperature (or pressure) and time to start cooking. Pressing this button while the unit is cooking will stop the function.

KEEP WARM button: After pressure cooking, steaming, or slow cooking, the unit will automatically switch to Keep Warm mode and start counting up. Keep Warm will stay on for 12 hours, or you may press KEEP WARM to turn it off. Keep Warm mode is not intended to warm food from a cold state but to keep it warm at a food-safe temperature.

POWER button: The Power button shuts the unit off and stops all cooking modes.

STANDBY MODE

After 10 minutes with no interaction with the control panel, the unit will enter standby mode.

BEFORE FIRST USE

- 1 Remove and discard any packaging material, promotional labels, and tape from the unit.
- 2 Remove all accessories from the package and read this manual carefully. Please pay particular attention to operational instructions, warnings, and important safeguards to avoid any injury or property damage.
- 3 Wash the pressure lid, silicone ring, removable cooking pot, Cook & Crisp™ Basket, reversible rack, and condensation collector in hot, soapy water, then rinse and dry thoroughly. **NEVER** clean the cooker base or pressure lid in the dishwasher. Inspect the pressure lid to ensure there is no debris blocking the valves.
- 4 The silicone ring is reversible and can be inserted in either direction. Insert the silicone ring around the outer edge of the silicone ring rack on the underside of the lid. Ensure it is fully inserted and lies flat under the silicone ring rack.

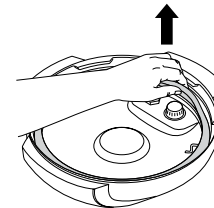

INSTALLING THE CONDENSATION COLLECTOR

To install the condensation collector, slide it into the slot on the cooker base. Slide it out to remove it for hand-washing after each use.

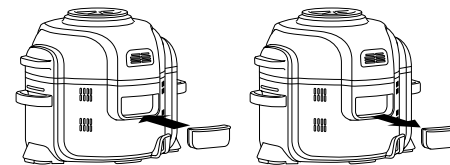

NOTE: Prior to each use, make sure the silicone ring is well seated in the silicone ring rack and the anti-clog cap is mounted properly on the pressure release valve.

REMOVING & REINSTALLING THE ANTI-CLOG CAP

Make sure your anti-clog cap is in the correct position before using the pressure lid. The anti-clog cap protects the inner valve of the pressure lid from clogging and protects users from potential food splatters. It should be cleaned after every use with a cleaning brush. To remove, hold the anti-clog cap between your thumb and bent index finger, then rotate your wrist clockwise to remove.

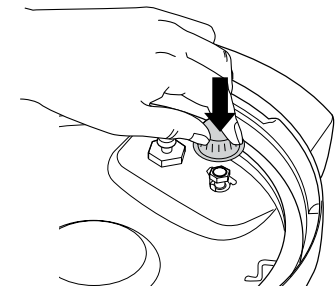
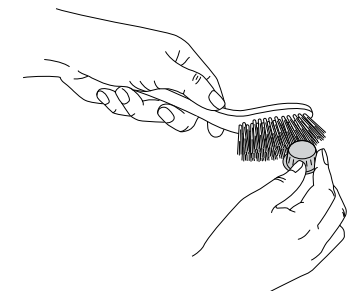
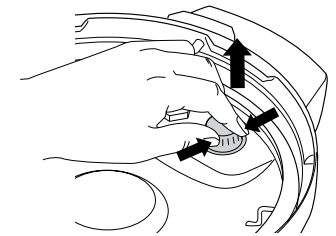

USING YOUR FOODI® DELUXE TENDERCRISP™ PRESSURE COOKER

DROP THE TOP

The two lids allow you to seamlessly transition between all your favorite cooking methods. Use the pressure lid to tenderize, then use the crisping lid to crisp up your food.

USING THE CRISPING LID

The crisping lid is affixed to the unit by a hinge and features an easy-open design. The lid can be opened during any convection cooking function so you can check on and access the ingredients. When the lid is opened, cooking will stop, the timer will pause, and the heating element in the lid will turn off. When the lid is closed, cooking will begin again and the timer will resume counting down.

USING THE COOKING FUNCTIONS WITH THE CRISPING LID

To turn on the unit, plug the power cord into a wall outlet, then press the Power button.

Air Crisp

- 1 Press the AIR CRISP button. The default temperature setting will display. Use the up and down TEMP arrows to choose a temperature between 300°F and 400°F.

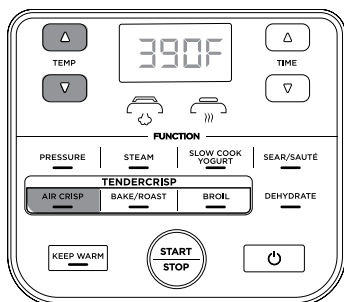

- 2 Use the up and down TIME arrows to set the cook time in minute increments up to 1 hour.

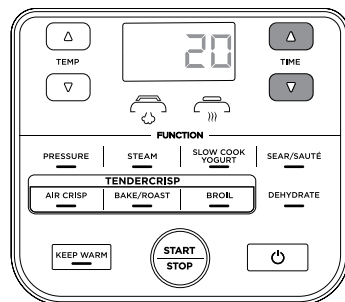

- 3 With the pot installed, place either the Cook & Crisp™ Basket or reversible rack in the pot. Basket should have diffuser attached.

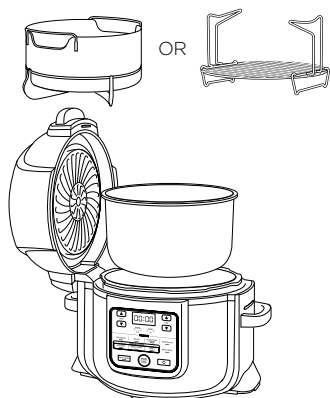

NOTE: It is recommended to let the unit preheat for 5 minutes before adding ingredients. If preheating, before step 4, close the lid, and press the START/STOP button to begin.

- 4 Add ingredients to the Cook & Crisp™ Basket or reversible rack. Close the lid and press the START/STOP button to begin cooking.

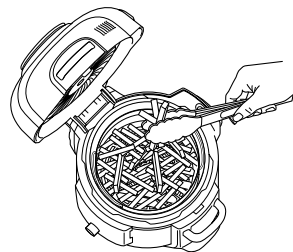

- 5 During cooking, you can open the lid and lift out the basket to shake or toss ingredients for even browning, if needed. When done, lower basket back into pot and close lid. Cooking will automatically resume after lid is closed.

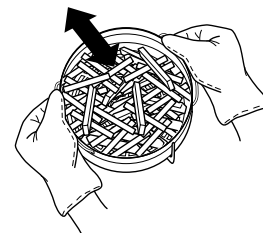

NOTE: If you press the STOP during Air Crisp Mode, the unit will wait 10 seconds before entering Standby mode.

- 6 When cook time is complete, the unit will beep.

Bake/Roast

- 1 Press the BAKE/ROAST button. The default temperature setting will display. Use the up and down TEMP arrows to choose a temperature between 250°F and 400°F.

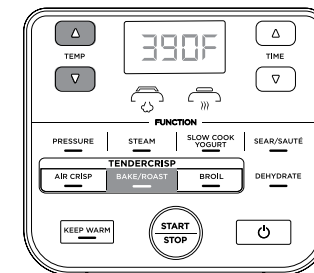

- 2 Use the up and down TIME arrows to set the cook time in minute increments up to 1 hour, 5-minute increments from 1 hour to 4 hours.

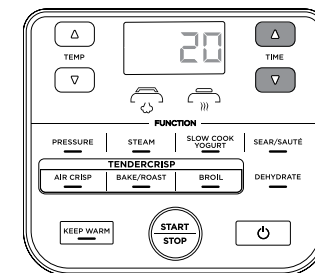

NOTE: If running for 1 hour or less, the clock will count down by minutes and seconds. If running for more than 1 hour, the clock will count down by minutes only.

NOTE: It is recommended to let the unit preheat for 5 minutes before adding ingredients. If preheating, before step 3, close the lid, and press the START/STOP button to begin.

- 3 Add ingredients, along with any accessories called for in your recipe, to the pot. Close the lid and press the START/STOP button to begin cooking.
- 4 When cook time is complete, the unit will beep.

USING YOUR FOODI® DELUXE TENDERCRISP™ PRESSURE COOKER - CONT.

Broil

- 1 Press the BROIL button.

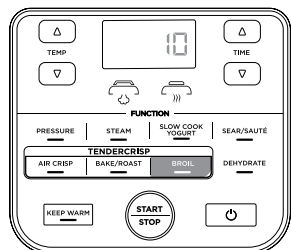

NOTE: There is no temperature adjustment available or necessary when using the Broil function.

- 2 Use the up and down TIME arrows to set the cook time in minute increments up to 30 minutes.

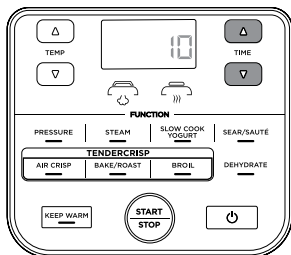

- 3 Place the reversible rack in the pot in the upper broil position or follow directions per recipe.

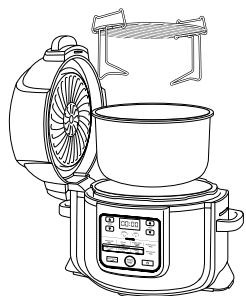

- 4 Place ingredients on the rack, then close the lid.

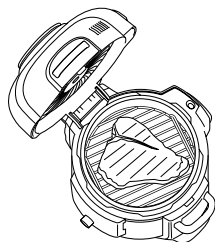

- 5 Press the START/STOP button to begin cooking.

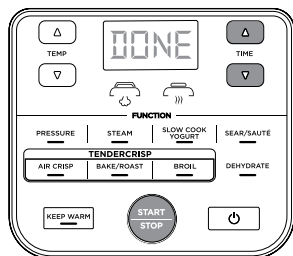

- 6 When cook time is complete, the unit will beep.

Dehydrate

- 1 Press the DEHYDRATE button. The default temperature setting will display. Use the up and down TEMP arrows to choose a temperature between 105°F and 195°F.

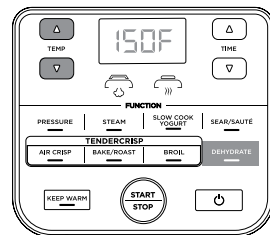

- 2 Use the up and down TIME arrows to set the cook time in 15-minute increments up to 12 hours.

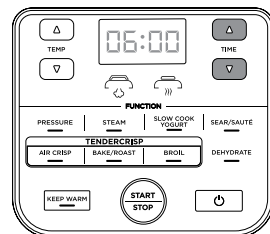

- 3 Place the ingredients on the bottom of the Cook & Crisp™ Basket.

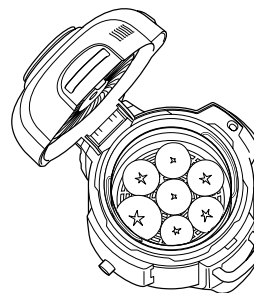

- 4 Add ingredients to the Cook & Crisp Layered Insert in the Cook & Crisp Basket to create two levels for dehydrating.

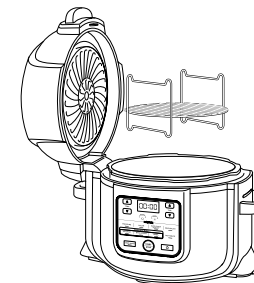

NOTE: For five levels of capacity, use the dehydrating rack* directly in the cooking pot.

- 5 Press the START/STOP button to begin dehydrating.

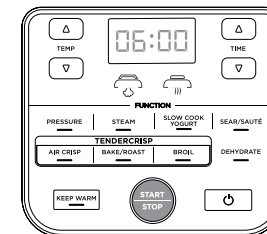

- 6 When cook time is complete, the unit will beep.

*The dehydrating rack is sold separately on ninjaccessories.com.

USING YOUR FOODI® DELUXE TENDERCRISP™ PRESSURE COOKER - CONT.

FAMILIARIZING YOURSELF WITH PRESSURE COOKING

In order to familiarize yourself with the Pressure Cook function and start cooking, it is highly recommended for first-time users to do an initial run.

- 1 Place the pot in the cooker base and add 3 cups room-temperature water to the pot.

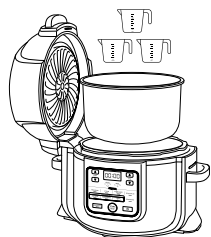

- 2 Assemble the pressure lid by aligning the arrow on the front of the lid with the arrow on the front of the cooker base. Then turn the lid clockwise until it locks in place.

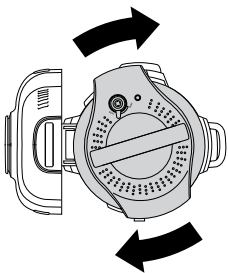

- 3 Make sure the pressure release valve on the lid is in the SEAL position.



- 4 Press the PRESSURE button, the unit will default to high (HI) pressure and a time setting of 2 minutes. Press the START/STOP button to begin.

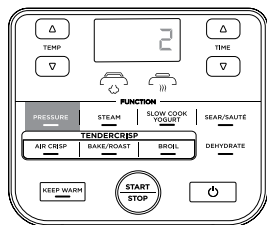

- 5 Your Foodi Deluxe will begin to build pressure, indicated by the rotating lights. The unit will begin counting down when it is fully pressurized

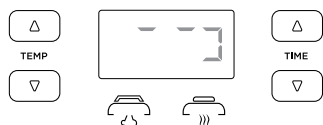

- 6 When the countdown is finished, the Foodi Deluxe will beep, automatically switch to the Keep Warm mode, and begin counting up.

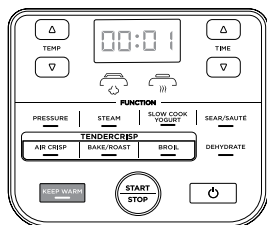

- 7 Turn the pressure release valve to the VENT position to quick release the pressurized steam. A quick burst of steam will spurt out of the pressure release valve. When steam is completely released, the unit will be ready to open.



NATURAL PRESSURE RELEASE VS. QUICK PRESSURE RELEASE

Natural Pressure Release: When pressure cooking is complete, steam will naturally release from the unit as it cools down. This can take up to 20 minutes or more, depending on the amount of liquid and food in the pot. During this time, the unit will switch to Keep Warm mode. Press the KEEP WARM button if you would like to turn Keep Warm mode off. When natural pressure release is complete, the float valve will drop down.

Quick Pressure Release: Use **ONLY** if your recipe calls for it. When pressure cooking is complete and the KEEP WARM light is on, turn the pressure release valve to the VENT position to instantly release pressure through the valve.

Even after releasing pressure naturally or using the pressure release valve, some steam will remain in the unit and will escape when the lid is opened. Lift and tilt it away from you, making sure no condensation drips into the cooker base.





NOTE: At any time during the natural release process, you can switch to quick release by turning the pressure release valve to the VENT position.

PRESSURIZING

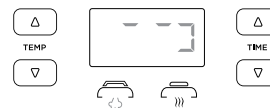
As pressure builds in the unit, the control panel will display rotating lights. Pressurizing time varies, depending on the amount of ingredients and liquid in the pot. As the unit pressurizes, the lid will lock as a safety measure, and it will not unlock until pressure is released. Once the unit has reached full pressure, the lid pressure icon light will glow steadily. The pressure cooking cycle will begin and the timer will start counting down.



INSTALLING & REMOVING THE PRESSURE LID

Place the pressure lid on top of the unit with the  on the lid and the  on the base lined up evenly. Turn the lid clockwise until it locks in place.

To unlock the pressure lid, turn it counterclockwise. Lift the lid at an angle to prevent splatter. Do not lift the lid straight up.

NOTE: The pressure lid will not unlock until the unit is completely depressurized.

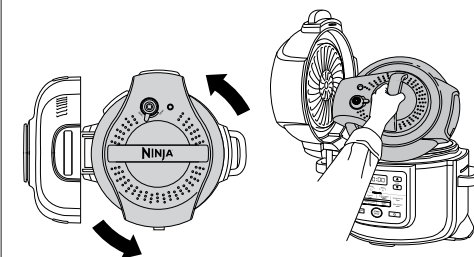
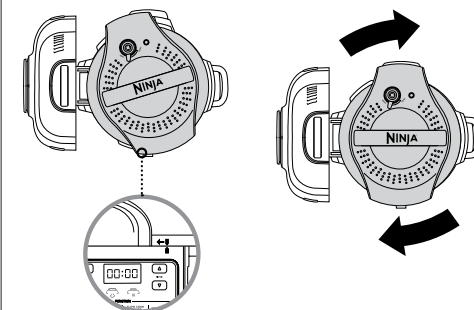
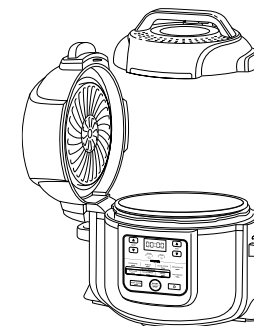

USING YOUR FOODI® DELUXE TENDERCRISP™ PRESSURE COOKER - CONT.

USING THE COOKING FUNCTIONS WITH THE PRESSURE LID

To turn on the unit, plug the power cord into a wall outlet, then press the Power button.

Pressure Cook

- Place ingredients and at least 1/2 cup of liquid in the pot, including an accessory if your recipe calls for it. **DO NOT** exceed the line marked PRESSURE MAX when pressure cooking.

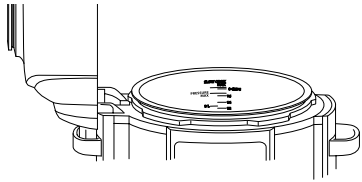

NOTE: When cooking rice, beans, or other ingredients that expand, **DO NOT** fill the pot more than halfway.

- Follow the instructions on page 15 to install the pressure lid. Turn the pressure release valve to the SEAL position.



- Press the PRESSURE button. The default pressure level will display. Use the up and down TEMP arrows to select either HIGH or LOW.

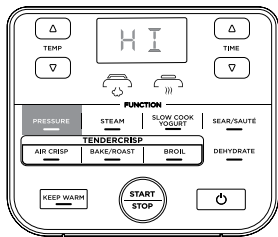

NOTE: If running for 1 hour or less, the clock will count down by minutes and seconds. If running for more than 1 hour, the clock will count down by minutes only.

- Use the up and down TIME arrows to set the cook time in minute increments up to 1 hour, and in 5-minute increments from 1 hour to 4 hours.

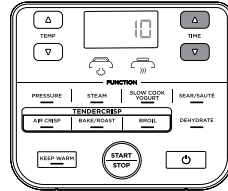

- Press the START/STOP button. The display will show rotating lights during this time. When the unit reaches the proper temperature, the time you set will begin counting down.



- When cook time is complete, the unit will beep, automatically switch to Keep Warm mode, and start counting up from 00:00.

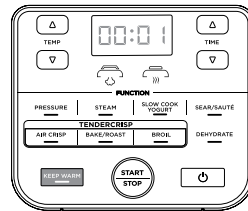

NOTE: After Pressure Cooking is complete, you may press the KEEP WARM button to turn the Keep Warm mode off.

- Let the unit naturally release pressure or, if the recipe instructs, turn the pressure release valve to the VENT position, quickly releasing steam through the valve.



Steam

- Add 1 cup of liquid (or amount of liquid the recipe specifies) to the pot, then place the reversible rack or Cook & Crisp™ Basket with ingredients in the pot.

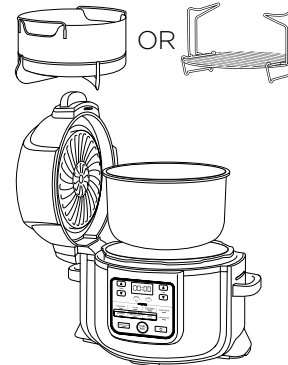

- Follow the instructions on page 15 to install the pressure lid. Turn the pressure release valve to the VENT position.



- Press the STEAM button. Use the up and down TIME arrows to set the cook time in minute increments up to 30 minutes.

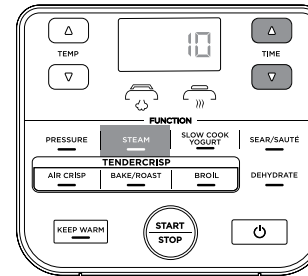

NOTE: There is no temperature adjustment available or necessary when using the Steam function.

- Press the START/STOP button.
- The unit will automatically preheat to bring the steaming liquid to a boil. The display will show rotating lights during this time. When the unit reaches the proper temperature, the time you set will begin counting down.

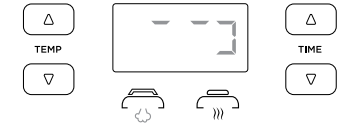

- When cook time is complete, the unit will beep and automatically switch to Keep Warm mode. If the float valve pops up, wait for it to drop and then you can open the lid.

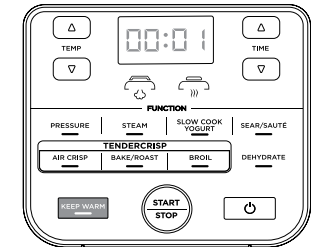

NOTE: After Steam cooking is complete, you may press the KEEP WARM button to turn the Keep Warm mode off.

USING YOUR FOODI® DELUXE TENDERCRISP™ PRESSURE COOKER - CONT.

Slow Cook

- 1 Add ingredients to the pot. **DO NOT** exceed the line marked MAX when slow cooking.
- 2 Follow the instructions on page 15 to install pressure lid. Turn the pressure release valve to the VENT position.



- 3 Press the SLOW COOK button. The default temperature setting will display. Use the up and down TEMP arrows to select either Slow Cook HIGH or LOW.

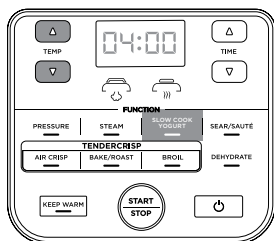

- 4 Use the up and down TIME arrows to set the cook time in 15-minute increments up to 12 hours.

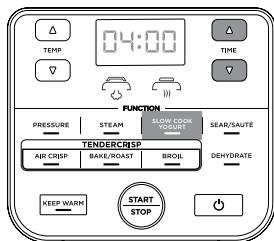

- 5 Press the START/STOP button to begin cooking.

NOTE: The Slow Cook HIGH time setting may be adjusted anywhere between 4 and 12 hours; the Slow Cook LOW time setting may be adjusted anywhere between 6 and 12 hours.

- 6 When cook time is complete, the unit will beep and automatically switch to Keep Warm mode.

Yogurt

- 1 Add desired amount of milk to the pot.

NOTE: If you prefer to pasteurize, cool, and add cultures without using the unit, skip steps 1-9. Instead, press the TEMP up arrow to select FMNT, then press the TIME arrows to select desired incubation time. Press START/STOP to begin, then follow steps 10 and 11.

- 2 Install the pressure lid and turn the pressure release valve to the VENT position.



- 3 Press SLOW COOK/YOGURT twice until YGRT appears on the screen. Press the TEMP arrows up or down to select YGRT or FMNT.

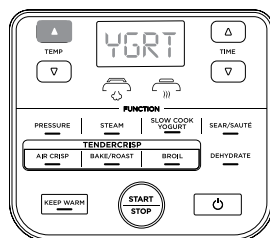

- 4 Press the TIME arrows to adjust the incubation time in 30-minute increments between 8 and 12 hours.

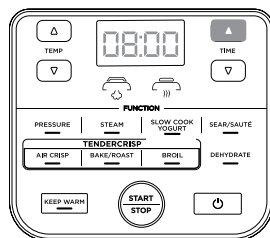

NOTE: Selecting a longer time will lead to tangier yogurt with a thicker consistency. Use 12 hours to achieve Greek-style yogurt.

- 5 Press START/STOP to begin pasteurization.
- 6 Unit will display BOIL while pasteurizing. When pasteurization temperature is reached, the unit will beep and display COOL.

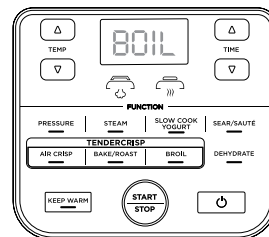

- 7 Once the milk has cooled, the unit will display ADD AND STIR in succession.

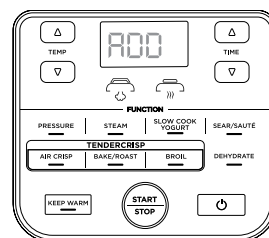

- 8 Remove the pressure lid and skim the top of the milk.
- 9 Add yogurt cultures to milk and stir to combine. Install the pressure lid (valve may be in VENT or SEAL position) and press START/STOP to begin incubation process.

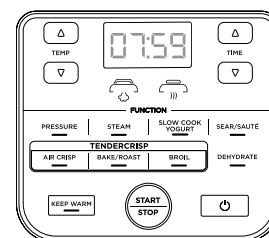

- 10 The display will begin counting down. When incubation time is complete, the unit will beep and display DONE.
- 11 Chill yogurt up to 12 hours before serving.

Sear/Sauté

- 1 Install the pot.

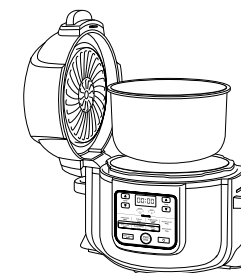

- 2 Press the SEAR/SAUTÉ button. The default temperature setting will display. Use the up and down TEMP arrows to select one of the setting options (low, medium-low, medium, medium-high, or high).

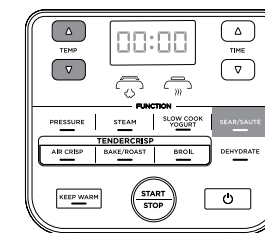

NOTE: There is no time adjustment available or necessary when using the Sear/Sauté function.

- 3 Press the START/STOP button to begin cooking.
- 4 To turn off the Sear/Sauté function, press the START/STOP button. To switch to a different cooking function, press the corresponding function button.

NOTE: You can use this function with either the crisping lid in the open position or the pressure lid with the pressure release valve in the VENT position.

NOTE: ALWAYS use nonstick utensils in the cooking pot. **DO NOT** use metal utensils, as they will scratch the nonstick coating on the pot.

ADDITIONAL ACCESSORIES AVAILABLE FOR PURCHASE

We offer a suite of accessories custom made for your Ninja® Foodi® Deluxe TenderCrisp™ Pressure Cooker. Visit ninjaaccessories.com to expand your capabilities and take your cooking to the next level.

Multi-Purpose Pan



- With this pan, you can create bubbly casseroles, dips, and sweet and savory pies, or bake a fluffy, moist cake with a golden top for dessert.
- Dimensions: 8.75" D x 2.5" H

Roasting Rack Insert

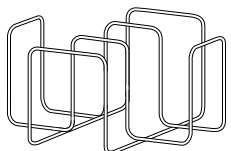

- Use this rack in the Cook & Crisp™ Basket to crisp up shells on Taco Tuesday, roast a rack of ribs on BBQ Sunday, or evenly toast garlic bread on pasta night.

Skewer Stand*

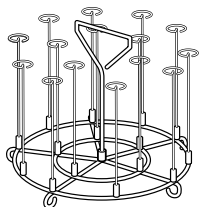

- This handy stand holds 15 skewers' worth of chicken, meat, seafood, and vegetables. Because of the Foodi's unique airflow, you get that perfect crisp to your juicy, tender creations. Compatible with 8-qt. unit only.

Dehydrating Rack

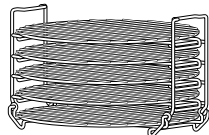

- Five stackable layers enable you to dehydrate fruits and meats or make crispy kale and vegetable chips.

Crisper Pan

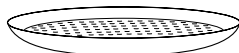

- Perforated with holes for improved airflow, this pan is great for crisping and reheating pizzas, quesadillas, and vegetables.
- Dimensions: 9" D x 0.75" H

Loaf Pan

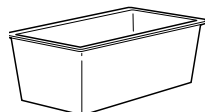

- Our specially designed pan is the perfectly sized baking accessory for bread mixes like banana and zucchini.
- Dimensions: 8.25" x 4.25" x 3.5"

Extra Pack of Silicone Rings



- 2-pack silicone ring set helps keep flavors separate—use one when cooking savory foods and the other when cooking sweet foods.

CLEANING & MAINTENANCE

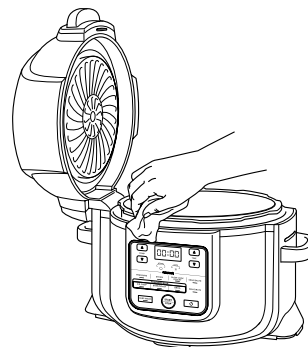

Cleaning: Dishwasher & Hand-Washing

The unit should be cleaned thoroughly after every use.

- 1 Unplug the unit from the wall outlet before cleaning.
- 2 **NEVER** put the cooker base in the dishwasher, or immerse it in water or any other liquid.
- 3 To clean the cooker base and the control panel, wipe them clean with a damp cloth.
- 4 The cooking pot, pressure lid, silicone ring, reversible rack, Cook & Crisp™ Layered Insert, Cook & Crisp Basket, and detachable diffuser can be washed in the dishwasher.

NOTE: DO NOT take apart the pressure release valve or float valve assembly.

- 5 To clean the crisping lid, wipe it down with a wet cloth or paper towel after the heat shield cools.
- 6 If food residue is stuck on the cooking pot, reversible rack, or Cook & Crisp Basket, fill the pot with water and allow to soak before cleaning. **DO NOT** use scouring pads. If scrubbing is necessary, use a non-abrasive cleanser or liquid dish soap with a nylon pad or brush.
- 7 Air-dry all parts after each use.

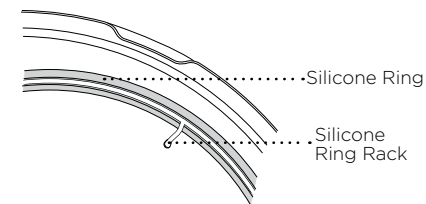
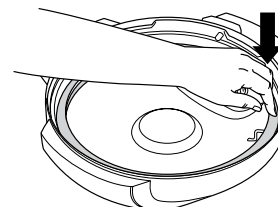
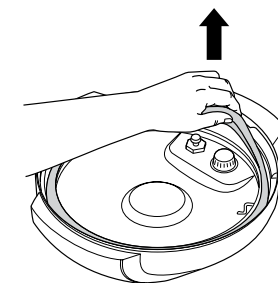

Removing & Reinstalling the Silicone Ring

To remove the silicone ring, pull it outward, section by section, from the silicone ring rack. The ring can be installed with either side facing up. To reinstall, press it down into the rack section by section.

After use, remove any food debris from the silicone ring and anti-clog cap.

Keep the silicone ring clean to avoid odor. Washing it in warm, soapy water or in the dishwasher can remove odor. However, it is normal for it to absorb the smell of certain acidic foods. It is recommended to have more than one silicone ring on hand. You can purchase additional silicone rings on ninjaaccessories.com.

NEVER pull out the silicone ring with excessive force, as that may deform it and the rack and affect the pressure-sealing function. A silicone ring with cracks, cuts, or other damage should be replaced immediately.

TROUBLESHOOTING GUIDE

Why is my unit taking so long to come to pressure? How long does it take to come to pressure?

- Cooking times may vary based on the selected temperature, current temperature of the cooking pot, and temperature or quantity of the ingredients.
- Check to make sure your silicone ring is fully seated and flush against the lid. If installed correctly, you should be able to tug lightly on the ring to rotate it.
- Check that the pressure lid is fully locked, and the pressure release valve is in the SEAL position when pressure cooking.

Why is the time counting down so slowly?

- You may have set hours rather than minutes. When setting time, the display will show HH:MM and the time will increase/decrease in minute increments.

How can I tell when the unit is pressurizing?

- The rotating lights will display on the screen to indicate the unit is building pressure.

Lights are rotating on the display screen when using the Pressure or Steam function.

- This indicates the unit is building pressure or preheating when using STEAM or PRESSURE. When the unit has finished building pressure, your set cook time will begin counting down.

There is a lot of steam coming from my unit when using the Steam function.

- It's normal for steam to release through the pressure release valve during cooking. Leave the pressure release valve in the VENT position for Steam, Slow Cook, and Sear/Sauté.

Why can't I take the pressure lid off?

- As a safety feature, the pressure lid will not unlock until the unit is completely depressurized. Turn the pressure release valve to the VENT position to quick release the pressurized steam. A quick burst of steam will spurt out of the pressure release valve. When the steam is completely released, the unit will be ready to open. Turn the pressure lid counterclockwise, then lift it up and away from you.

Is the pressure release valve supposed to be loose?

- Yes. The pressure release valve's loose fit is intentional; it enables a quick and easy transition between SEAL and VENT and helps regulate pressure by releasing small amounts of steam during cooking to ensure great results. Please make sure it is turned as far as possible toward the SEAL position when pressure cooking and as far as possible toward the VENT position when quick releasing.

The unit is hissing and not reaching pressure.

- Make sure the pressure release valve is turned to the SEAL position. If you've done this and still hear a loud hissing noise, it may indicate your silicone seal is not fully in place. Press START/STOP to stop cooking, VENT as necessary, and remove the pressure lid. Press down on the silicone ring, ensuring it is fully inserted and lies flat under the ring rack. Once fully installed, you should be able to tug lightly on the ring to rotate it.

The unit is counting up rather than down.

- The cooking cycle is complete and the unit is in Keep Warm mode.

How long does the unit take to depressurize?

- The time it takes to release pressure depends on the quantity of food in the unit and can vary from recipe to recipe. Always ensure the float valve has dropped before trying to remove the lid. If the unit is taking longer than normal to depressurize, unplug the unit and wait until the float valve drops before removing the lid.

“POT” error message appears on display screen.

- Cooking pot is not inside the cooker base. Cooking pot is required for all functions.

“LID” error message appears on display screen and lid icon flashes.

- The incorrect lid is installed for your desired cooking function. Place the pressure lid on the unit if you want to use the Pressure, Slow Cook, Steam, Sear/Sauté, or Keep Warm functions. Make sure the lid is in the closed position.

“SHUT” error message appears on display screen.

- The crisping lid is open and needs to be closed for the selected function to start.

“VENT” error message appears on display screen.

- When set to Slow Cook or Sear/Sauté, and the unit senses pressure building up, this message indicates the pressure release valve is in the SEAL position.
- Turn the pressure release valve to the VENT position and leave it there for the remainder of the cooking function.
- If you do not turn the pressure release valve to the VENT position within 5 minutes, the program will cancel and the unit will shut off.

“WATR” error message appears on display screen when using the Steam function.

- The water level is too low. Add more water to the unit for the function to continue.

“WATR” error message appears on display screen when using the Pressure function.

- Add more liquid to the cooking pot before restarting the pressure cook cycle.
- Make sure the pressure release valve is in the SEAL position.
- Make sure the silicone ring is installed correctly.

“HOT” error message appears on display screen.

- This indicates the unit has overheated. Let the unit cool down.
- Once unit has cooled down, ensure there is no food caked on the bottom of the pot and there is enough liquid in the pot for the recipe you are preparing.

“ERR” message appears.

- The unit is not functioning properly. Please contact Customer Service at 1-877-646-5288.

HELPFUL TIPS

- For consistent browning, make sure ingredients are arranged in an even layer in the Cook & Crisp™ Plate or cooking pot with no overlapping. If ingredients are overlapping, make sure to shake them halfway through the set cook time.
- For smaller ingredients that could fall through the nesting broil rack, we recommend first placing them on parchment paper or foil.
- When switching from pressure cooking to using the crisping lid, we recommend emptying the pot of any remaining liquid for best crisping results.
- Press and hold down the TIME up or down arrow to get to your desired time faster.
- Use the Keep Warm mode to keep food at a warm, food-safe temperature after cooking. To prevent food from drying out, we recommend keeping the pressure lid closed and using this function just before serving. To reheat cold food, use the Air Crisp function.

REPLACEMENT PARTS

To order additional parts and accessories, visit ninjaaccessories.com or contact Customer Service at **1-877-646-5288**. We ask that you register your product online at registeryourninja.com and have the product on hand when you call, so we may better assist you.

Shark | NINJA

ONE (1) YEAR LIMITED WARRANTY

The One (1) Year Limited Warranty applies to purchases made from authorized retailers of **SharkNinja Operating LLC**. Warranty coverage applies to the original owner and to the original product only and is not transferable.

SharkNinja warrants that the unit shall be free from defects in material and workmanship for a period of one (1) year from the date of purchase when it is used under normal household conditions and maintained according to the requirements outlined in the Owner's Guide, subject to the following conditions and exclusions:

What is covered by this warranty?

1. The original unit and/or non-wearable parts deemed defective, in SharkNinja's sole discretion, will be repaired or replaced up to one (1) year from the original purchase date.
2. In the event a replacement unit is issued, the warranty coverage ends six (6) months following the receipt date of the replacement unit or the remainder of the existing warranty, whichever is later. SharkNinja reserves the right to replace the unit with one of equal or greater value.

What is not covered by this warranty?

1. Normal wear and tear of wearable parts (including removable pot, silicone ring, lids, racks, baskets, etc.) that require regular maintenance and/or replacement to ensure the proper functioning of your unit, are not covered by this warranty. Replacement parts are available for purchase at ninjaaccessories.com.
2. Any unit that has been tampered with or used for commercial purposes
3. Damage caused by misuse, abuse, negligent handling, failure to perform required maintenance (e.g., failure to keep the main unit, pressure lid, and crisping lid clear of food spills and other debris), or damage due to mishandling in transit.
4. Consequential and incidental damages.
5. Defects caused by repair persons not authorized by SharkNinja. These defects include damages caused in the process of shipping, altering, or repairing the SharkNinja product (or any of its parts) when the repair is performed by a repair person not authorized by SharkNinja.
6. Products purchased, used, or operated outside North America.

How to get service

If your appliance fails to operate properly while in use under normal household conditions within the warranty period, visit ninjakitchen.com/support for product care and maintenance self-help. Our Customer Service Specialists are also available at **1-877-646-5288** to assist with product support and warranty service options. So we may better assist you, please register your product online at registeryourninja.com and have the product on hand when you call.

SharkNinja will cover the cost for the customer to send in the unit to us for repair or replacement. A fee of \$19.95 (subject to change) will be charged when SharkNinja ships the repaired or replacement unit.

How to initiate a warranty claim

You must call **1-877-646-5288** to initiate a warranty claim. You will need the receipt as proof of purchase. We also ask that you register your product online at registeryourninja.com and have the product on hand when you call, so we may better assist you. A Customer Service Specialist will provide you with return and packing instruction information.

How state law applies

This warranty gives you specific legal rights, and you also may have other rights that vary from state to state. Some states do not permit the exclusion or limitation of incidental or consequential damages, so the above may not apply to you.

SharkNinja Operating LLC
Needham, MA 02494
1-877-646-5288
ninjakitchen.com

Illustrations may differ from actual product. We are constantly striving to improve our products, therefore the specifications contained herein are subject to change without notice.

FOODI and NINJA are registered trademarks of SharkNinja Operating LLC.

COOK & CRISP and TENDERCRISP are trademarks of SharkNinja Operating LLC.

For SharkNinja U.S. Patent information, visit sharkninja.com/uspatents/

© 2020 SharkNinja Operating LLC

PRINTED IN CHINA

OP401_IB_E_REV_Mv5



@ninjakitchen