

# NINJA®

**DZ400Q**  
Series

**OWNER'S GUIDE**

## Foodi XL 2-BASKET AIR FRYER





# THANK YOU

for purchasing the Ninja® Foodi® 2-Basket Air Fryer



## REGISTER YOUR PURCHASE

-  [registeryourninja.com](https://registeryourninja.com)
-  Scan QR code using mobile device

## RECORD THIS INFORMATION

Model Number: \_\_\_\_\_  
Serial Number: \_\_\_\_\_  
Date of Purchase: \_\_\_\_\_  
(Keep receipt)  
Store of Purchase: \_\_\_\_\_

## TECHNICAL SPECIFICATIONS

Voltage: 120V~, 60Hz  
Watts: 1690W

**TIP:** You can find the model and serial numbers on the QR code label on the back of the unit by the power cord.

# CONTENTS

<b>Important Safeguards</b> .....	<b>2</b>
<b>Parts</b> .....	<b>4</b>
<b>Getting to Know Your Ninja® Foodi® 2-Basket Air Fryer</b> .....	<b>5</b>
Function Buttons .....	5
Operating Buttons .....	5
<b>Before First Use</b> .....	<b>5</b>
<b>Cooking in Your 2-Basket Air Fryer</b> .....	<b>6</b>
Cooking with DualZone™ Technology .....	6
<b>Cooking in a Single Zone</b> .....	<b>8</b>
Air Fry .....	8
Bake .....	9
Roast .....	9
Air Broil .....	10
Reheat .....	11
Dehydrate .....	11
<b>Pausing &amp; Ending Cook Times</b> .....	<b>12</b>
Pausing Time in a Single Zone .....	12
Ending the Cook Time in One Zone (while using both zones) ..	12
<b>Cleaning Your 2-Basket Air Fryer</b> .....	<b>14</b>
<b>Helpful Tips</b> .....	<b>14</b>
<b>Replacement Parts</b> .....	<b>14</b>
<b>Troubleshooting Guide</b> .....	<b>15</b>
<b>Warranty</b> .....	<b>16</b>

# IMPORTANT SAFEGUARDS

HOUSEHOLD USE ONLY. READ ALL INSTRUCTIONS.

When using electrical appliance, basic safety precautions should always be followed, including the following:

## ⚠ WARNINGS

- 1 This appliance can be used by persons with reduced physical, sensory or mental capabilities or lack of experience and knowledge if they have been given supervision or instruction concerning use of the appliance in a safe way and understand the hazards involved.
- 2 Keep the appliance and its cord out of reach of children. **DO NOT** allow the appliance to be used by children. Close supervision is necessary when used near children
- 3 Children should not play with the appliance.
- 4 **NEVER** use electrical socket below counter.
- 5 **NEVER** connect this appliance to an external timer switch or separate remote-control system.
- 6 When using this appliance, provide at least 6 inches (15.25 cm) of space above and on all sides for air circulation.
- 7 To protect against electrical shock **DO NOT** immerse cord, plugs, or main unit housing in water or other liquid. Cook only in the basket provided .
- 8 Regularly inspect the appliance and power cord. **DO NOT** use the appliance if there is damage to the power cord or plug. If the appliance malfunctions or has been damaged in any way, immediately stop use and call Customer Service.
- 9 **DO NOT** use an extension cord. A short power-supply cord is used to reduce the risk of children grabbing the cord or becoming entangled and to reduce the risk of people tripping over a longer cord.
- 10 **ALWAYS** ensure the appliance is properly assembled before use.
- 11 **DO NOT** cover the air intake vent or air outlet while unit is operating. Doing so will prevent even cooking and may damage the unit or cause it to overheat.
- 12 Before placing removable basket into the main unit, ensure basket and unit are clean and dry by wiping with a soft cloth.
- 13 This appliance is for household use only. **DO NOT** use this appliance for anything other than its intended use. **DO NOT** use in moving vehicles or boats. **DO NOT** use outdoors. Misuse may cause injury.
- 14 Intended for worktop use only. Ensure the surface is level, clean and dry. **DO NOT** move the appliance when in use.
- 15 **DO NOT** place the appliance near the edge of a worktop during operation.
- 16 **DO NOT** use accessory attachments not recommended or sold by SharkNinja. Do not place accessories in a microwave, toaster oven, convection oven, or conventional oven or on a ceramic cooktop, electric coil, gas burner range or outdoor grill. The use of accessory attachments not recommended by SharkNinja may cause fire, electric shock or injuries.
- 17 **ALWAYS** ensure basket is properly closed before operating.
- 18 **DO NOT** use the appliance without the removable basket installed.
- 19 **DO NOT** use this appliance for deep-frying.
- 20 **DO NOT** place appliance on hot surfaces or near a hot gas or electric burner or in a heated oven.
- 21 Prevent food contact with heating elements. **DO NOT** overfill when cooking. Overfilling may cause personal injury or property damage or affect the safe use of the appliance.

- 22 **DO NOT** place items on top of unit at any time.
- 23 Socket voltages can vary, affecting the performance of your product. To prevent possible illness, use a thermometer to check that your food is cooked to the temperatures recommended.
- 24 Should the unit emit black smoke, unplug immediately. Wait for smoking to stop before removing any cooking accessories.
- 25 **DO NOT** touch hot surfaces. Appliance surfaces are hot during and after operation. To prevent burns or personal injury, **ALWAYS** use protective hot pads or insulated oven mitts and use available handles.
- 26 Extreme caution must be used when the appliance contains hot food. Improper use may result in personal injury.
- 27 This appliance has a polarized plug (one blade is wider than the other). To reduce the risk of electric shock, this plug is intended to fit into a polarized outlet only one way. If the plug does not fit fully into the outlet, reverse the plug. If it still does not fit, contact a qualified electrician. **DO NOT** attempt to modify the plug in any way.
- 28 Spilled food can cause serious burns. Keep appliance and cord away from children. **DO NOT** let cord hang over edges of tables or counters or touch hot surfaces.
- 29 The basket and crisper plate become extremely hot during the cooking process. Avoid physical contact while removing the basket or plate from the appliance. **ALWAYS** place basket or plate on a heat-resistant surface after removing. **DO NOT** touch accessories during or immediately after cooking.
- 30 Cleaning and user maintenance should not be carried out by children.
- 31 To disconnect, press the power button to turn off the unit, then unplug from socket when not in use and before cleaning. Allow to cool before cleaning, disassembly, putting in or taking off parts and storage.
- 32 **DO NOT** clean with metal scouring pads. Pieces can break off the pad and touch electrical parts, creating the risk of electric shock.
- 33 Please refer to the Cleaning & Maintenance section for regular maintenance of the appliance.



Indicates to read and review instructions to understand operation and use of product.



Indicates the presence of a hazard that can cause personal injury, death or substantial property damage if the warning included with this symbol is ignored.



Take care to avoid contact with hot surface. Always use hand protection to avoid burns.



For indoor and household use only.

## SAVE THESE INSTRUCTIONS

## PARTS

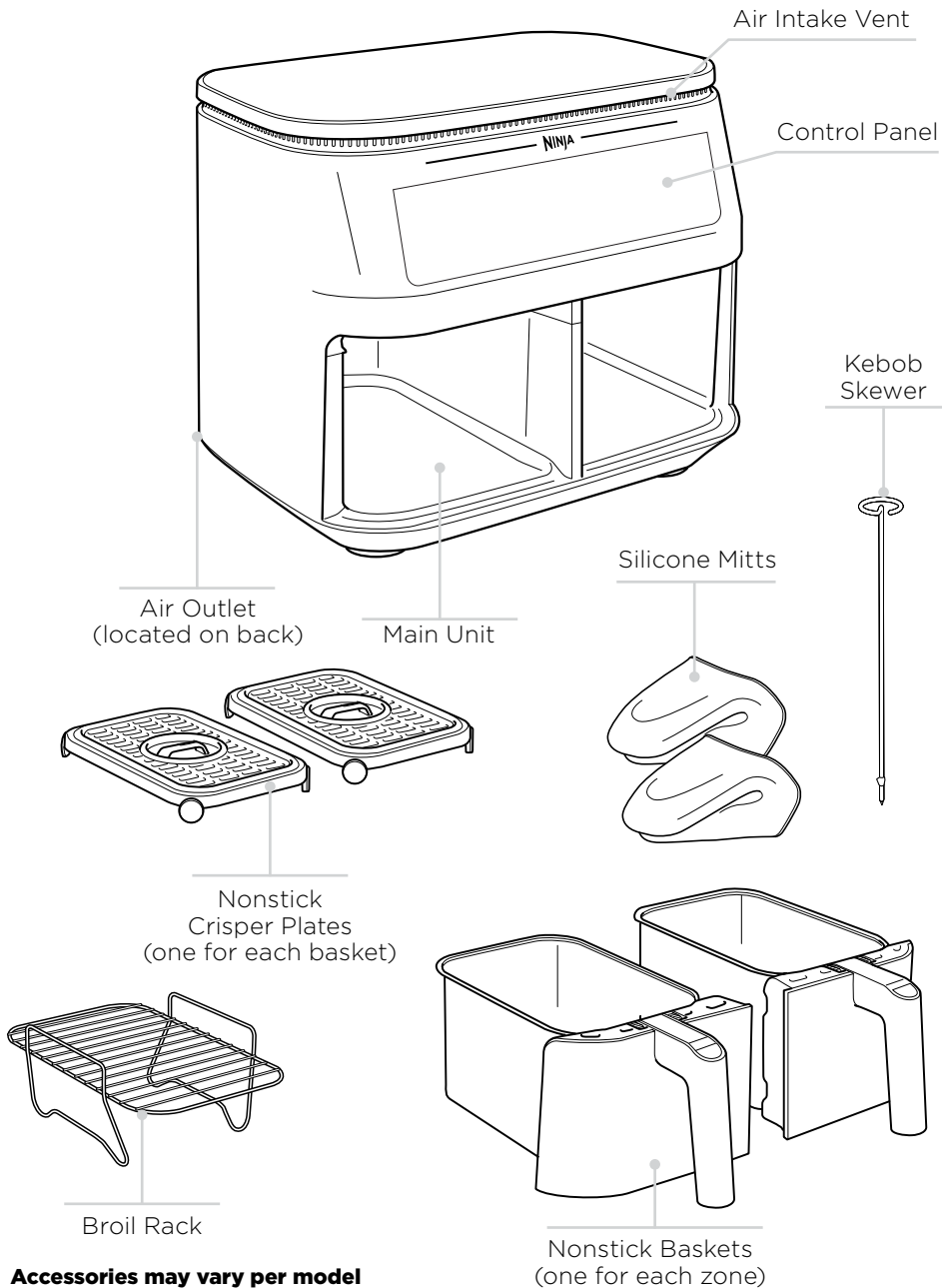

Accessories may vary per model

## GETTING TO KNOW YOUR NINJA® FOODI® XL 2-BASKET AIR FRYER

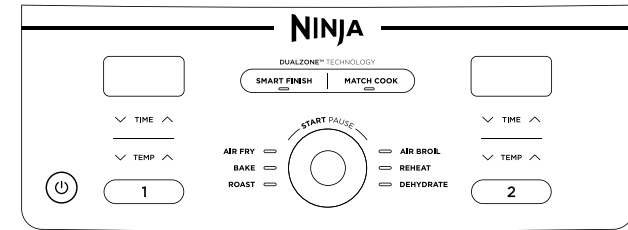

When setting time, the digital display shows HH:MM.

### FUNCTIONS

**AIR FRY:** Use this function to give your food crispiness and crunch with little to no oil.

**BAKE:** Create decadent baked treats and desserts.

**ROAST:** Roast meats to tenderize and more.

**AIR BROIL:** Add the crispy finishing touch to meals, or melt toppings to create the perfect finish.

**REHEAT:** Warm your leftovers, with a crispy result.

**DEHYDRATE:** Dehydrate meats, fruits, and vegetables for healthy snacks.

### OPERATING BUTTONS

- ① Controls the output for the basket on the left.
- ② Controls the output for the basket on the right.

**TEMP arrows:** Use the up and down arrows to adjust the cook temperature before or during cooking.

**TIME arrows:** Use the up and down arrows to adjust the cook time in any function before or during the cook cycle.

**SMART FINISH button:** Automatically syncs the cook times to ensure both zones finish at the same time, even if there are different cook times.

**MATCH COOK button:** Automatically matches Zone 2 settings to those of Zone 1 to cook a larger amount of the same food, or cook different foods using the same function, temperature, and time.

**DIAL:** Turn the dial from side to side to select desired cook function. Press center of dial to start or pause cooking.

**POWER BUTTON:** The  button turns the unit on and off and stops all cooking functions.

**Standby Mode:** After 10 minutes of no interaction with the control panel, the unit will enter standby mode. The Power button will be dimly lit.

**Hold Mode:** Hold will appear on the unit while in SMART FINISH mode. One zone will be cooking, while the other zone will be holding until the times sync together.

**NOTE:** Not all models include all functions.

## BEFORE FIRST USE

- 1 Remove and discard any packaging material, promotional labels, and tape from the unit.
- 2 Remove all accessories from the package and read this manual carefully. Please pay particular attention to operational instructions, warnings, and important safeguards to avoid any injury or property damage.
- 3 Wash the baskets and crisper plates in hot, soapy water, then rinse and dry thoroughly. The crisper plates and baskets are the **ONLY** dishwasher-safe parts. **NEVER** clean the main unit in the dishwasher.

# COOKING IN YOUR 2-BASKET AIR FRYER

## REFERENCE QUICK START GUIDE FOR RECIPES AND COOKING CHARTS

### COOKING WITH DUALZONE™ TECHNOLOGY

DualZone Technology utilizes two cooking zones to increase versatility. The Smart Finish feature ensures that, regardless of different cook settings, both zones will finish ready to serve at the same time. For detailed instructions on using each function, see pages 10-13.

#### SMART FINISH

To finish cooking at the same time when foods have different cook times, temps, or even functions:

- 1 Place ingredients in the baskets, then insert baskets in unit.
- 2 Zone 1 will remain illuminated. Use the dial to select the desired cook function. Use the TEMP arrows to set the temperature, and use the TIME arrows to set the time.

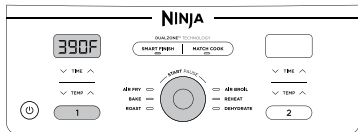

- 3 Select Zone 2, then use the dial to select the desired cook function (Air Broil can be used in only one zone when using Smart Finish). Use the TEMP arrows to set the temperature, and use the TIME arrows to set the time.

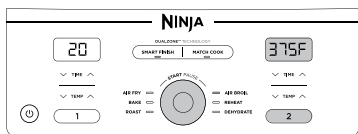

**NOTE:** Air Broil can be used in only one zone.

**NOTE:** You can select a different function for Zone 2.

- 4 Press SMART FINISH, then press center of dial to begin cooking in the zone with the longest time. The other zone will display **Hold**. The unit will beep and activate the second zone when both zones have the same time remaining.

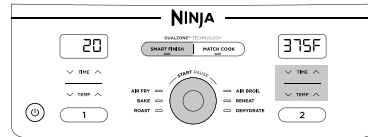

**NOTE:** It is recommended to shake your food during cooking. To keep the time at a synchronized finish, press center of dial to pause both zones. To pause a single zone during dual zone cooking, refer to page 8.

- 5 When cooking is complete, the unit will beep and “End” will appear on the display.

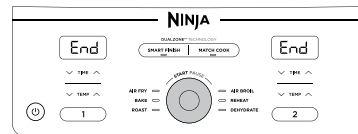

- 6 Remove ingredients by dumping them out or using silicone-tipped tongs/utensils. **DO NOT** place drawer on top of unit.

**NOTE:** If you decide the food in one of the zones is done cooking before the cook time is up, you can **STOP A ZONE**. Select that zone, then press center of dial to pause the zone or set the time to zero. See page 11 for further instructions.

### MATCH COOK

To cook a larger amount of the same food, or cook different foods using the same function, temperature, and time:

- 1 Place ingredients in the baskets, then insert baskets in unit.
- 2 Zone 1 will remain illuminated. Use the dial to select the desired cook function (Air Broil is not available for use in either zone when using Match Cook). Use the TEMP arrows to set the temperature, and use the TIME arrows to set the time.

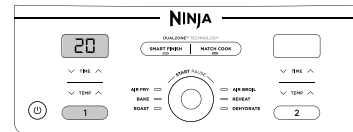

- 3 Press the MATCH COOK button to copy the Zone 1 settings to Zone 2. Then press center of dial to begin cooking in both zones.

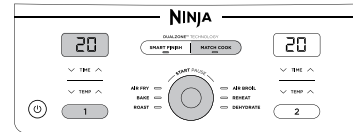

**NOTE:** Air Broil cannot be used in Match Cook mode.

**NOTE:** It is recommended to shake your food during cooking. To keep the time at a synchronized finish, press center of dial to pause both zones. To pause a single zone during dual zone cooking, refer to page 8.

- 4 “End” will appear on both screens when cooking ends at the same time.

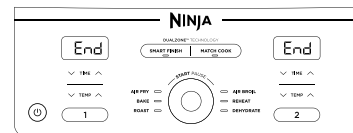

- 5 Remove ingredients by dumping them out or using silicone-tipped tongs/utensils.

### COOKING WITH TWO ZONES

When Smart Finish or Match Cook are not selected, technology is integrated into the design to automatically optimize the distribution of power when using two zones with different cook times. This means the food in the zone with the longer cook time may finish cooking before the set time ends. Check food frequently to avoid overcooking.

- 1 Select Zone 1, then use the dial to select the desired cook function. Use the TEMP arrows to set the temperature.



- 2 Use the TIME arrows to set the time.



- 3 Repeat steps 2 and 3 for Zone 2.



- 4 Press center of dial to begin cooking in both zones.

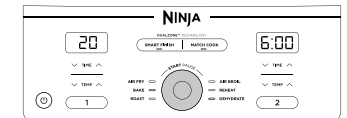

- 5 When cooking is complete in the zone with the shorter cook time, the power will then shift to help optimize cook time in the remaining zone.
- 6 Continue to monitor food, as it may finish cooking before the set cook time ends.
- 7 Remove ingredients by dumping them out or using silicone-tipped tongs/utensils.

# COOKING IN YOUR 2-BASKET AIR FRYER - CONT.

## COOKING IN A SINGLE ZONE

For instructions on using both zones at the same time, see pages 6–7.

To turn on the unit, plug the power cord into a wall outlet, then press the power  button.

### Air Fry

- 1 Install crisper plate in the basket, then place ingredients in the basket, and insert basket in unit.

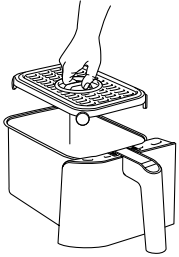

- 2 The unit will default to Zone 1 (to use Zone 2 instead, select Zone 2). Select AIR FRY.

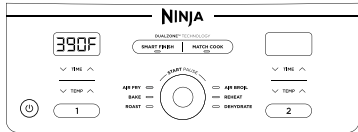

- 3 Use the TEMP arrows to set the desired temperature.

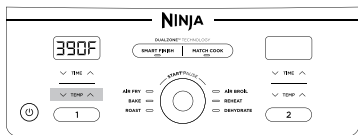

- 5 Use the TIME arrows to set the time in 1-minute increments up to 1 hour. Press center of dial to begin cooking.

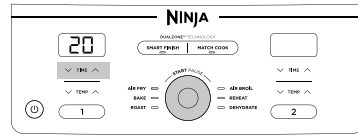

**NOTE:** During cooking, you can remove the basket and shake or toss ingredients for evening crisping. If you would like to pause during this time, press the zone number then press center of dial. If using a single zone, press center of dial.

- 6 When cooking is complete, the unit will beep and “End” will appear on the display.

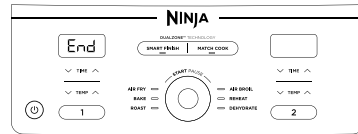

- 7 Remove ingredients by dumping them out or using silicone-tipped tongs/utensils.

## Bake

- 1 Install crisper plate in the basket (optional), then place ingredients in the basket, and insert basket in unit.



- 2 The unit will default to Zone 1 (to use Zone 2 instead, select Zone 2). Use the dial to select BAKE.

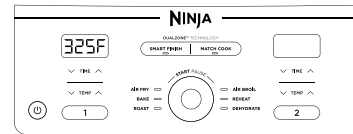

**NOTE:** To convert recipes from a traditional oven, reduce the temperature by 25°F.

- 3 Use the TEMP arrows to set the desired temperature.

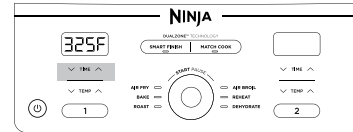

- 4 Use the TIME arrows to set the time in 1-minute increments up to 1 hour and in 5-minute increments from 1 to 4 hours. Press center of dial to begin cooking.

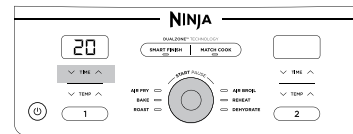

- 5 When cooking is complete, the unit will beep and “End” will appear on the display.

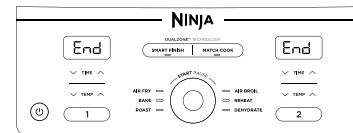

- 6 Remove ingredients by dumping them out or using silicone-tipped tongs/utensils.

## Roast

- 1 Install crisper plate in the basket (optional), then place ingredients in the basket, and insert basket in unit.



- 2 The unit will default to Zone 1 (to use Zone 2 instead, select Zone 2). Use the dial to select ROAST.

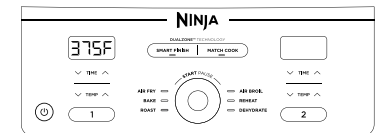

- 3 Use the TEMP arrows to set the desired temperature.



- 4 Use the TIME arrows to set the time in 1-minute increments up to 1 hour and in 5-minute increments from 1 to 4 hours. Press center of dial to begin cooking.

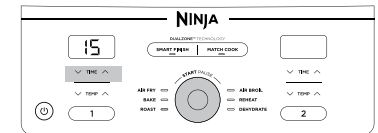

- 5 When cooking is complete, the unit will beep and “End” will appear on the display.



- 6 Remove ingredients by dumping them out or using silicone-tipped tongs/utensils.

# COOKING IN YOUR 2-BASKET AIR FRYER – CONT.

## Air Broil (Not available on all models.)

**NOTE:** AIR BROIL cannot be used in both zones at the same time.

- 1 Install crisper plate in the basket, then place ingredients in the basket, and insert basket in unit.

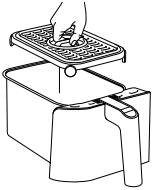

- 2 The unit will default to Zone 1 (to use Zone 2 instead, select Zone 2). Select AIR BROIL.

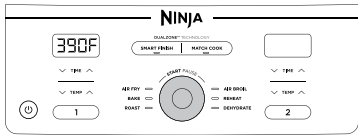

- 3 Use the TEMP arrows to set the desired temperature.

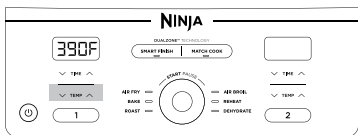

- 4 Use the TIME arrows to set the time in 1-minute increments up to 30 minutes. Press center of dial to begin cooking.

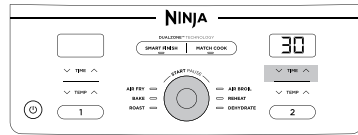

- 5 When cooking is complete, the unit will beep and “End” will appear on the display.

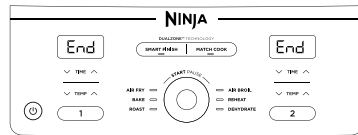

- 6 Remove ingredients by dumping them out or using silicone-tipped tongs/utensils.

## Reheat

- 1 Install crisper plate in the basket (optional), then place ingredients in the basket, and insert basket in unit.

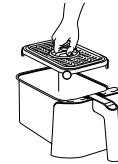

- 2 The unit will default to Zone 1 (to use Zone 2 instead, select Zone 2). Use the dial to select REHEAT.

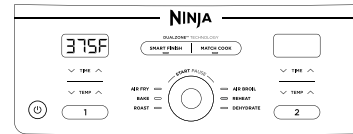

- 3 Use the TEMP arrows to set the desired temperature.



- 4 Use the TIME arrows to set the time in 1-minute increments up to 1 hour. Press center of dial to begin reheating.

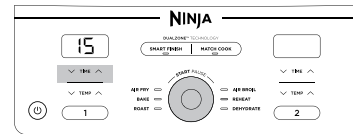

- 5 When reheating is complete, the unit will beep and “End” will appear on the display.



- 6 Remove ingredients by dumping them out or using silicone-tipped tongs/utensils.

## Dehydrate

- 1 Place a single layer of ingredients in the basket. Then install the crisper plate in the basket on top of the ingredients and place another layer of ingredients on the crisper plate.
- 2 The unit will default to Zone 1 (to use Zone 2 instead, select Zone 2). Use the dial to select DEHYDRATE. The default temperature will appear on the display. Use the TEMP arrows to set the desired temperature.

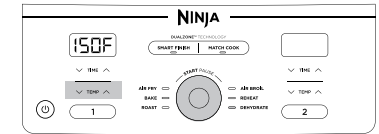

- 3 Use the TIME arrows to set the time in 15-minute increments from 1 to 12 hours. Press center of dial to begin dehydrating.

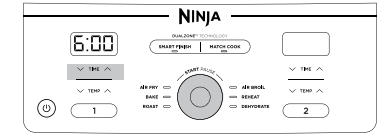

- 4 When cooking is complete, the unit will beep and “End” will appear on the display.

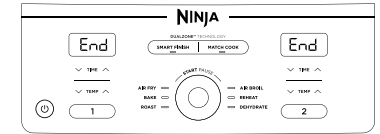

- 5 Remove ingredients by dumping them out or using silicone-tipped tongs/utensils.

# COOKING IN YOUR 2-BASKET AIR FRYER – CONT.

## PAUSING BOTH ZONES AT THE SAME TIME

- 1 To pause time in the SMART FINISH mode, or to pause both zones in dual zone cooking, press center of dial.

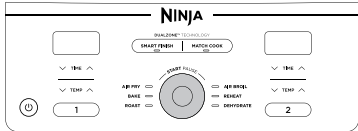

- 2 To resume cooking, press center of dial again.

## PAUSING A SINGLE ZONE DURING DUAL ZONE COOKING

- 1 To pause time in a single zone while both zones are running, select the zone you want to pause, then press center of dial.

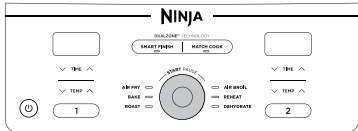

- 2 To resume cooking, press center of dial again.

## ENDING THE COOK TIME IN ONE ZONE (WHILE USING BOTH ZONES)

- 1 Select the zone you would like to stop.

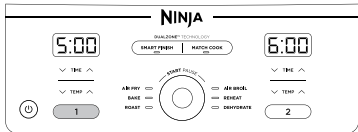

- 2 Then press the down TIME arrow to set the time to zero.



- 3 Once you have set the time to zero, press the START/PAUSE button.
- 4 The time in that zone is then canceled, and “End” will appear on the display. Cooking will continue in the other zone.



## Air Broil (Not available on all models.)

**NOTE:** AIR BROIL cannot be used in both zones at the same time.

- 1 Install crisper plate in the basket, then place ingredients in the basket, and insert basket in unit.

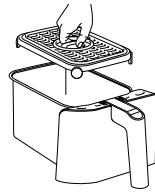

- 2 The unit will default to Zone 1 (to use Zone 2 instead, select Zone 2). Select AIR BROIL.

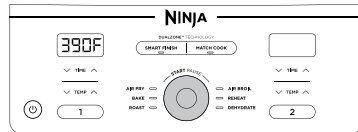

- 3 Use the TEMP arrows to set the desired temperature.



## HOW TO USE YOUR BROIL RACK

### Air Broil

- 1 Install crisper plate in the basket, then add the broil rack on top of the plate. Use the broil rack for best air broil and roasting results and for an extra layer of cooking.





## CLEANING YOUR 2-BASKET AIR FRYER

The unit should be cleaned thoroughly after every use. Unplug the unit from the wall outlet before cleaning.

Part/Accessory	Cleaning Method	Dishwasher Safe?
Main Unit	To clean the main unit and the control panel, wipe them clean with a damp cloth. <b>NOTE: NEVER</b> immerse the main unit in water or any other liquid. <b>NEVER</b> clean the main unit in a dishwasher.	No
Crisper Plates	The crisper plates can be washed in the dishwasher or by hand. If hand-washing, air-dry or towel-dry all parts after use.	Yes
Baskets	The baskets can be washed in the dishwasher or by hand. If hand-washing, air-dry or towel-dry all parts after use. *To extend the life of your basket, we recommend hand-washing them.	Yes*

If food residue is stuck on the crisper plates or baskets, place them in a sink filled with warm, soapy water and allow to soak.

## HELPFUL TIPS

- For consistent browning, make sure ingredients are arranged in an even layer on the bottom of the basket with no overlapping. If ingredients are overlapping, make sure to shake them halfway through cooking.
- Cook temperature and time can be adjusted at any time during cooking. Simply select the zone you want to adjust, then press the TEMP arrows to adjust the temperature or the TIME arrows to adjust the time.
- To convert recipes from a traditional oven, reduce the temperature by 25°F. Check food frequently to avoid overcooking.
- Occasionally, the fan from the air fryer will blow lightweight foods around. To alleviate this, secure foods (like the top slice of bread on a sandwich) with wooden toothpicks.
- The crisper plates elevate ingredients in the baskets so air can circulate under and around ingredients for even, crisp results.
- After selecting a cooking function, you can press center of dial to begin cooking immediately. The unit will run at the default temperature and time.
- For best results with fresh vegetables and potatoes, use at least 1 tablespoon of oil. Add more oil as desired to achieve the preferred level of crispiness.
- For best results, check progress throughout cooking and remove food when desired level of brownness has been achieved. We recommend using an instant-read thermometer to monitor the internal temperature of proteins.
- For best results, remove food directly after the cook time ends to avoid overcooking.

## REPLACEMENT PARTS

To order additional parts and accessories, visit [ninjaaccessories.com](http://ninjaaccessories.com) or contact Customer Service at 1-877-646-5288.

## TROUBLESHOOTING GUIDE

- How do I adjust the temperature or time while using a single zone?**  
When a single zone is running the time or temperature can be adjusted at any time by pressing the up/down arrows.
- How do I adjust the temperature or time while using both zones?**  
Select the desired zone, then use the TEMP arrows to adjust the temperature or the TIME arrows to adjust the time.
- Can I cook different foods in each zone and not worry about cross contamination?**  
Yes, both zones are self-contained with separate heating elements and fans.
- How do I pause or stop one zone when using both zones?**  
Select the zone you want to pause or stop, then press center of dial.
- Are the baskets safe to put on my countertop?**  
The baskets will heat up during cooking. Use caution when handling, and place them on heat-safe surfaces only. **DO NOT** place the baskets on the top of the unit.
- When should I use the crisper plate?**  
Use the crisper plate when you want food to come out crispy. The plate elevates the food in the basket so that air can flow under and around it to cook ingredients evenly.
- Why didn't my food cook fully?**  
Make sure the basket is fully inserted during cooking. For consistent browning, make sure ingredients are arranged in an even layer on the bottom of the basket with no overlapping. Shake basket to toss ingredients for even crispiness. Cook temperature and time can be adjusted at any time during cooking. Simply use the TEMP arrows to adjust the temperature or the TIME arrows to adjust the time.
- Why is my food burned?**  
For best results, check progress throughout cooking and remove food when desired level of brownness has been achieved. Remove food immediately after the cook time ends to avoid overcooking.
- Why do some ingredients blow around when air frying?**  
Occasionally, the fan from the air fryer will blow lightweight foods around. Use wooden toothpicks to secure loose lightweight food, like the top slice of bread on a sandwich.
- Can I air fry wet, battered ingredients?**  
Yes, but use the proper breading technique. It is important to coat foods first with flour, then with egg, and then with bread crumbs. Press breading firmly onto the battered ingredients, so crumbs won't be blown off by the fan.
- Why did the display screen go black?**  
The unit is in standby mode. Press the power @ button to turn it back on.
- Why is the unit beeping?**  
Either the food is done cooking, or the other zone has started cooking.
- Why is there an "E" message on the display screen?**  
The unit is not functioning properly. Please contact Customer Service at 1-877-646-5288.
- Why did a circuit breaker trip while using the unit?**  
The unit uses 1690 watts of power, so it must be plugged into an outlet on a 15-amp circuit breaker. Using an outlet on a 10-amp breaker will cause the breaker to trip. It is also important that the unit be the only appliance plugged into an outlet when in use. To avoid tripping a breaker, make sure the unit is the only appliance plugged into an outlet on a 15-amp breaker.



**SharkNinja Operating LLC**  
**US: Needham, MA 02494**  
**1-877-646-5288**  
**ninjakitchen.com**

Illustrations may differ from actual product. We are constantly striving to improve our products, therefore the specifications contained herein are subject to change without notice.

FOODI and NINJA are registered trademarks of SharkNinja Operating LLC.

DUALZONE is trademark of SharkNinja Operating LLC.

This product may be covered by one or more U.S. patents. See [sharkninja.com/patents](http://sharkninja.com/patents) for more information.

© 2021 SharkNinja Operating LLC

PRINTED IN CHINA

DZ400QSeries\_IB\_MP\_Mv2



**@ninjakitchen**