

NINJA

COFFEE BAR®

CF111
OWNER'S GUIDE



ninjakitchen.com
1-877-646-5288

IMPORTANT SAFEGUARDS

For Household Use Only

READ ALL INSTRUCTIONS BEFORE USING YOUR NINJA COFFEE BAR®.

Safety Signal Words

This manual and the safety labels attached to this appliance utilize signal words that signify safety hazards with different levels of severity.

Below are the words used and the definitions for these words:

- **WARNING** indicates a hazardous situation which, if not avoided, could result in death or serious injury.
- **CAUTION** indicates a hazardous situation which, if not avoided, could result in minor or moderate injury.
- **NOTICE** is used to address practices not related to physical injury.

The words “**WARNING**” and “**CAUTION**” are preceded by a triangle signifying that these are safety-related.

The terms “**IMPORTANT**” and “**NOTE**” are also used to describe good ideas for better and more efficient equipment use.

THIS BOOK COVERS MODEL NUMBER:

CF111

TECHNICAL SPECIFICATIONS

Voltage: 120V~, 60Hz.
Power: 1400 Watts
Water Reservoir Capacity: 43 Ounces

WARNING:

To reduce the risk of fire, electric shock, serious injury, death or damage when using this appliance, follow these basic safety precautions.

General Precautions

- 1 **DO NOT** allow young children to operate the appliance or use as a toy. Close supervision is necessary when any appliance is used near children.
- 2 To reduce the risk of electric shock, this appliance has a polarized plug (one blade is wider than the other). As a safety feature, this plug will fit into a polarized outlet only one way. If the plug does not fit fully into the outlet, reverse the plug. If it still does not fit, contact a qualified electrician. **DO NOT** force into outlet or try to modify to fit.
- 3 To protect against electrical shock, **DO NOT** submerge the appliance or allow the power cord to come into contact with water or any other liquid.
- 4 Allow the appliance to cool before taking off parts and before cleaning.
- 5 **NEVER** carry the appliance by the power cord or yank it to disconnect from electrical outlet; instead grasp the plug and pull to disconnect.
- 6 **DO NOT** operate any appliance with a damaged cord or plug, or after the appliance malfunctions, or has been dropped or damaged in any manner.
- 7 **DO NOT** let the power cord hang over the edge of table or counter or touch hot surfaces such as the stove.

- 8 Extension cords are not recommended for use with this product.
- 9 **DO NOT** remove the brew basket while the appliance is brewing. **Scalding may occur if any of these parts are removed during brewing cycles.**
- 10 The use of any accessories not recommended by the manufacturer may create an overflow condition and scalding hazard, or result in fire, electric shock, or personal injury.
- 11 **DO NOT** operate your appliance in an appliance garage or under a wall cabinet. When storing in an appliance garage always unplug the unit from the electrical outlet. Not doing so could create a risk of fire, especially if the appliance touches the walls of the garage or the door touches the unit as it closes.

Operating Notice

- 12 Do not use well water, use tap water.
- 13 Clogging and backing up of water and/or coffee in the filter basket can occur under any of the following conditions: The use of coffee that is too finely ground; using two or more paper filters; using a permanent filter in conjunction with a paper filter; not cleaning coffee grounds from a permanent filter; or allowing coffee grounds to spill over the filter.
- 14 **ALWAYS** use appliance on a dry, level surface.
- 15 Do not place on or near a hot gas or electric burner, or in a heated oven.
- 16 **DO NOT** use this appliance for anything other than its intended use. **DO NOT** use outdoors.

- 17 **DO NOT** touch hot surfaces. Use handles or knobs.
- 18 **DO NOT** reach across top of brewer to froth during brewing. Steam is released from vent on top of brewer and can result in a steam burn.

Maintenance

- 19 Remove the power cord from the electrical outlet and allow unit to cool before removing brew basket, water reservoir, or filters before surface cleaning.
- 20 To prevent illness from bacterial growth in the appliance, follow all cleaning instructions in the Care & Maintenance section of this Owner's Guide.”
- 21 If the product is not operating properly contact SharkNinja Operating LLC at 1-877-646-5288 or ninjakitchen.com for examination, repair or adjustment.
- 22 Clean the system on a weekly basis.
- 23 To prevent illness from bacterial growth in the appliance, follow all cleaning instructions in the “Care & Maintenance” section of this owner's guide.

Cord Statement

- 24 A short power-supply cord is provided to reduce the risks resulting from becoming entangled in or tripping over a longer cord.
- 25 **DO NOT** use extension cords with this product.

SAVE THESE INSTRUCTIONS

Contents

Thank you for purchasing the Ninja Coffee Bar®.

Getting To Know Your Ninja Coffee Bar	4
Control Panel	5
Features Of The Ninja Coffee Bar	6
Before First Use	7
Assembly	8
Preparing and Using the Ninja Coffee Bar	9
How Much Coffee Do You Get In Your Cup?	9
Would You Like A Hotter Coffee?	9
Pre-Heating	9
Filling The Brew Basket With Coffee	10
Drip Stop	11
Brewing Coffee	11
Classic and Rich Brew	11
Over Ice Brew	12
Signature Brews: Specialty and Cafe Forte Brew	13
Frothing Your Milk	14
Care & Maintenance	15
Cleaning After A Brew	15
Cleaning & Descaling Your Brewing System	15
Cleaning Your Water Reservoir	16
Cleaning The Frother	16
Troubleshooting Guide	17
Replacement Parts	18
Warranty & Registration	22

Getting To Know Your Ninja Coffee Bar®

⚠ Caution: DO NOT reach across top of brewer to froth during brewing. Steam is released from vent on top of brewer and can result in a steam burn.

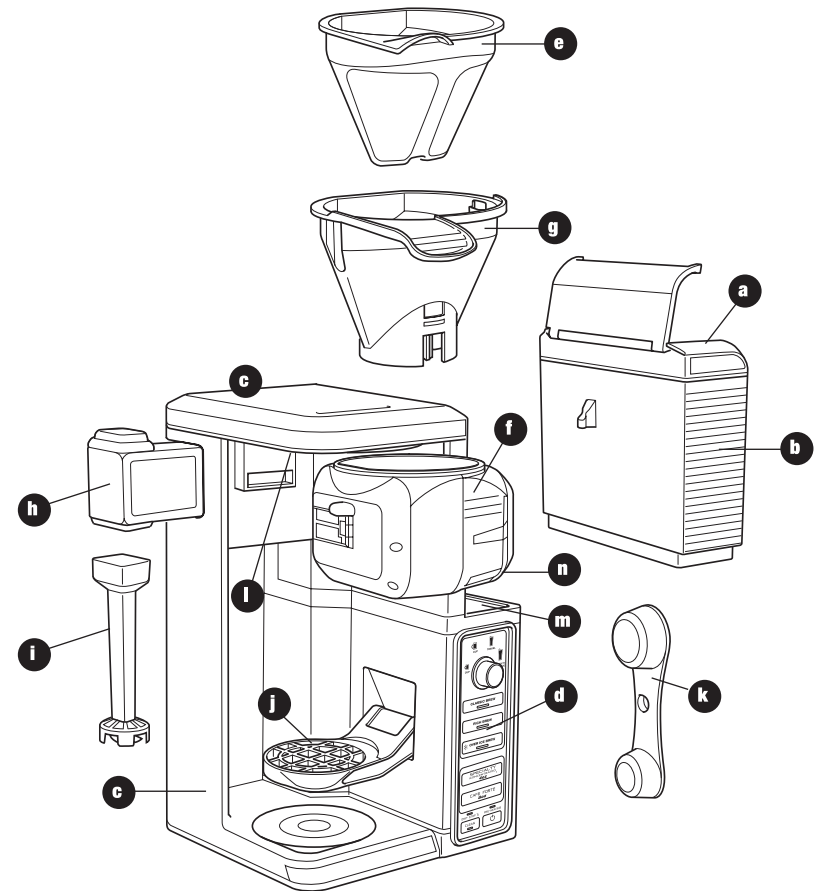

- a Flip-Top Water Reservoir Lid
- b Removable Water Reservoir
- c Brewer
- d Control Panel
- e Premium Permanent Filter
- f Swinging Brew Basket
- g Removable Filter Holder
- h Integrated Frother

- i Frother Whisk
- j Multi-Serve Cup Platform
- k Double-Sided Scoop: Big Scoop and Small Scoop
- l Shower Head
- m Water Tank Shelf
- n Drip Stop Toggle
- o Power Cord & Wrap (not shown)

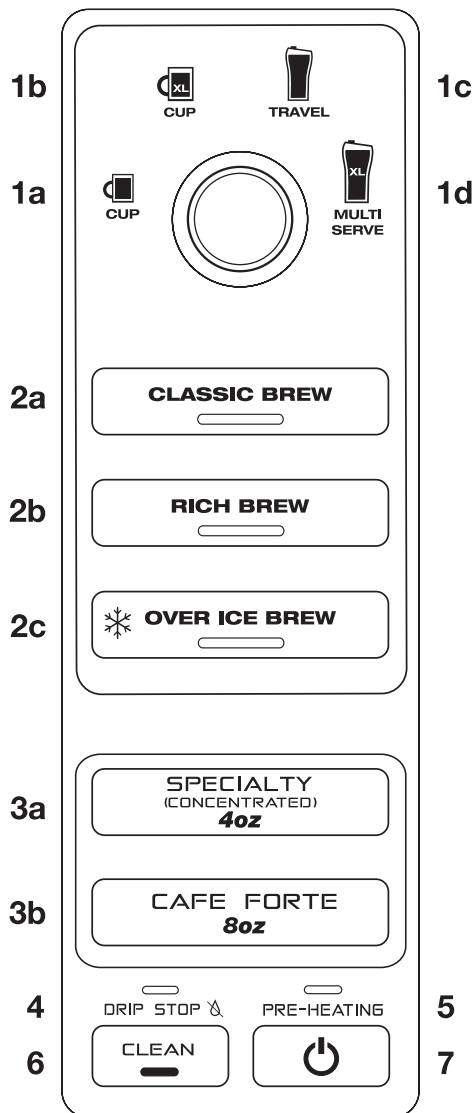

- 1 Multi-Serve Dial
 - a Cup
 - b XL Cup
 - c Travel Mug
 - d XL Multi-Serve
- 2 Custom Brew Types
 - a Classic Brew Button
 - b Rich Brew Button
 - c Over Ice Brew Button
- 3 Ninja Signature Brew Types
 - a Specialty Brew Button
 - b Cafe Forte Brew Button
- 4 Drip Stop Indicator
- 5 Pre-Heat indicator
- 6 Intelligent Clean Cycle Indicator/Button
- 7 Power Save Button

- **Thermal Flavor Extraction® Technology** - Blends Precision Water Delivery with automated controls for Calibrated Temperature, Pre-infusion, Coffee Saturation, and Flavor Richness. Ninja's Thermal Flavor Extraction technology can truly unlock the full flavor potential of your coffee.
- **Custom Brews** – Ability to brew directly into your favorite cup or travel mug.
- **Brew Types** – control the strength and style of your coffee:
 - a. Classic Brew for smooth, balanced flavor from your favorite coffee.
 - b. Rich Brew for a richer, never-bitter coffee flavor that stands up to milk, cream, or flavoring.
 - c. Over Ice Brew for a smooth, rich, freshly brewed iced coffee that's not watered down.
 - d. Specialty Brew to create a super-rich concentrate to use as a key ingredient in all kinds of hot milk-based, iced, and frozen coffeehouse-style drinks.
 - e. Cafe Forte for deep, full-bodied, and complex flavor that is so rich and drinkable, it tastes great black—no milk or sweeteners needed.
- **Multi-Serve Cup Platform** – Pull it down, place your favorite cup on it and brew directly into it.
- **Removable Water Reservoir with Easy Access Flip-Top Lid** – For quick and easy filling.
- **Auto-iQ®** – The Ninja Coffee Bar knows how much water to use for each size and brew type.
- **Clean Function** – It illuminates when your Ninja Coffee Bar senses that there is hard water calcium buildup in your brewer which can affect the flavor of your coffee. When it illuminates, follow the cleaning instructions in the Care & Maintenance section.
- **Audible Ready Signal** – Alerts you that your coffee is ready.
- **Premium Permanent Filter** - A reusable filter that preserves the natural coffee oils and small coffee particles to provide a robust flavor, similar to what you would experience when using a French press.
- **Pre-Heat** - After plugging in or turning your brewer on from Power Save mode, allow 3 minutes for your brewer to pre-heat. When plugged in, your Ninja Coffee Bar will stay ready in pre-warmed mode unless you put the brewer into power save mode.
- **Integrated Frother**- Housed conveniently on the side of our newest Ninja Coffee Bar brewer, the Integrated Frother transforms milk into a velvety-smooth foam topping for your favorite indulgent coffee drinks with just the touch of a button.
- **Drip Stop** - Stops the flow of coffee from the brew basket, allowing you to pour a cup mid-brew; switch toggle to the closed position to prevent dripping once the brew cycle is finished.

Brew into a cup or travel mug

Cup or XL Cup

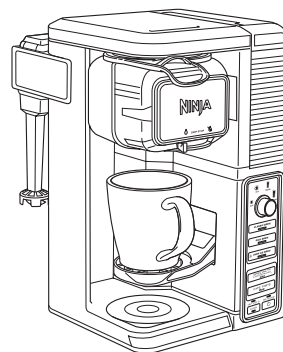

Travel Mug & XL Multi-Serve

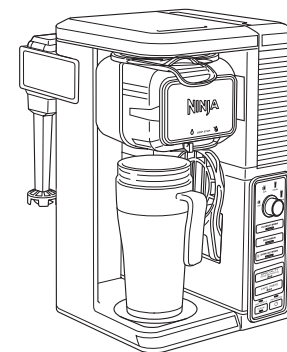

PLEASE KEEP THESE IMPORTANT SAFEGUARDS IN MIND WHEN USING THE APPLIANCE:

- ⚠ **CAUTION: APPLIANCE CREATES HOT LIQUID. HANDLE WITH CARE.**
- ⚠ **CAUTION: Never open the brew basket when the coffeemaker is in use.**
- ⚠ **CAUTION: Please ensure that you are using at least a 12 oz. cup for the cup size, 14 oz. cup for the XL Cup size, 16 oz. travel mug for the travel mug size and 20 oz. travel mug for the XL Multi-Serve size to prevent overflow and a scalding injury.**
- ⚠ **CAUTION: DO NOT remove the vessel while the appliance is running without the Drip Stop in the closed position. Return the vessel quickly and open the Drip Stop to continue the brew.**

IMPORTANT: DO NOT run the appliance without water.

IMPORTANT: Always place a vessel beneath the brew basket to receive the brewed coffee.

IMPORTANT: DO NOT overfill the water reservoir. Fill water only to the Max Fill line.

Assembly

⚠ **CAUTION: Only fill water reservoir up to, but not exceeding the Max Fill line with water; we recommend fresh, cool, filtered water. Do not fill water reservoir with any other liquids such as brewed coffee, carbonated beverages, etc. as other liquids may damage your brewer.**

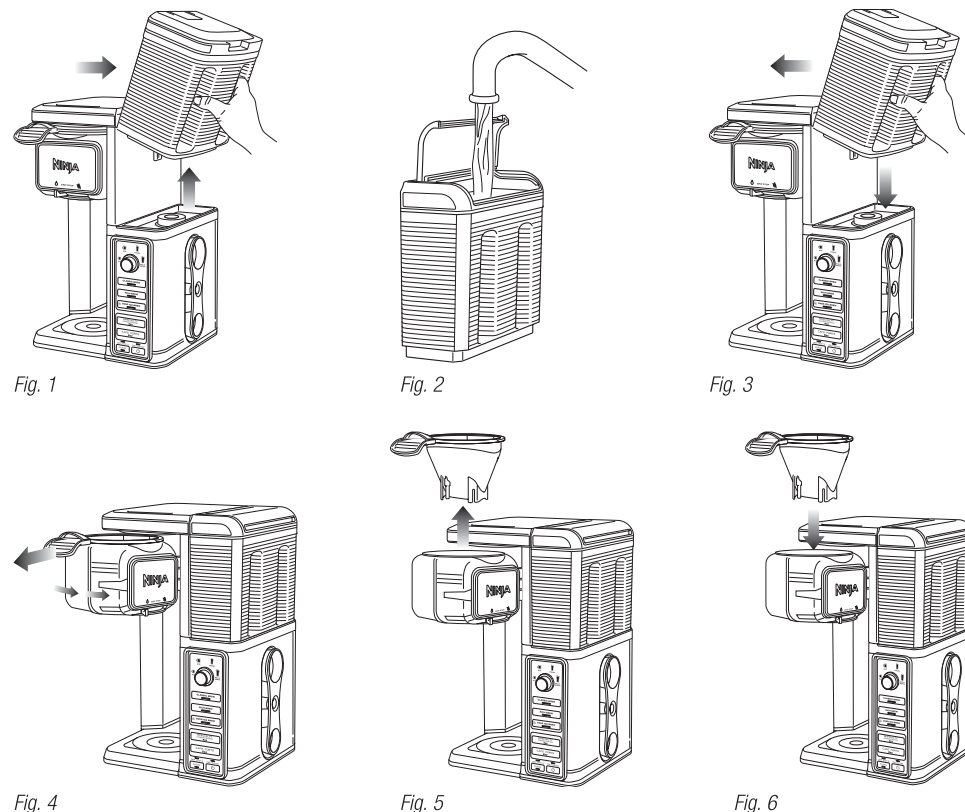

- 1 Remove all packaging material, stickers and labels from the brewer.
- 2 Wash the water reservoir, Premium permanent filter, frother whisk, and brew basket in warm, soapy water with a soft cloth.
- 3 Rinse and dry thoroughly.
- 4 Before first use, prime the system by running two travel mug cycles with water only. After each cycle is complete, discard the brew.

- 1 Place the brewer on a dry, clean and level surface.
- 2 To easily fill the water reservoir, use the hand grips to lift the reservoir to the right and up off the brewer. (Fig. 1) The water reservoir lid flips open, and the entire lid is easily removable for quick cleaning. Add fresh, filtered water at or above the minimum fill line for your desired beverage size (Fig. 2), then return the water reservoir to the brewer by angling the reservoir into the holder and pushing in towards the brewer to lock into place. (Fig. 3) Do not fill water reservoir with any other liquids such as brewed coffee, carbonated beverages, etc. as other liquids may damage your brewer.
- 3 Slide brew basket out (Fig. 4) and lift both the Premium permanent filter and the removable filter holder from the brew basket. (Fig. 5) To reinsert, set the Premium permanent filter and removable filter holder back into the brew basket. (Fig. 6)

- 4 Once the filter is in place, slide the brew basket all the way in until you hear a slight click.
- 5 Place your travel mug on the base of the brewer underneath the brew basket.
NOTE: Do not use any coffee for the first two brew cycles in order to clean the brewer.
- 6 Plug the brewer into an electrical outlet.
- 7 Once all parts are securely in place, press the Power Save button then press the CLEAN button to thoroughly clean the machine before first use.
- 8 Discard the water in the travel mug and repeat, beginning from step 2, with one more Clean Cycle of water before first use.

Preparing and using the Ninja Coffee Bar®

HOW MUCH COFFEE DO YOU GET IN YOUR CUP?

CAUTION: Please ensure that you are using at least a 12 oz. cup for the cup size, 14 oz. cup for the XL Cup size, 16 oz. travel mug for the travel mug size and 20 oz. travel mug for the XL Multi-Serve size to prevent overflow and a scalding injury.

Each size and brew type produces a different amount of coffee to optimize strength, taste, and size.

NOTE: The coffee grounds will absorb some of the water that is brewed, resulting in slightly less brewed coffee than water used.





APPROXIMATE BREW VOLUME

Size/Brew	Classic	Rich	Over Ice (coffee only)	Over Ice (filled with ice)
Cup	9.5 oz.	8.7 oz.	3.8 oz.	9.5 oz.
XL Cup	11.5 oz.	10.3 oz.	4.6 oz.	11.5 oz.
Travel Mug	14 oz.	13.2 oz.	5.9 oz.	14 oz.
XL Multi-Serve	18 oz.	16 oz.	7.3 oz.	18 oz.

Our Specialty Brew is always 4 oz. and Cafe Forte is always 8 oz., so you don't need to adjust the dial for our Signature brews.

WOULD YOU LIKE A HOTTER COFFEE?

Have you ever wondered why coffee is served in paper cups when you order it to go? The type of cup you brew into can drastically influence the drinking temperature.

	CERAMIC CUP			NINJA® CUP	PAPER CUP
Cup Temperature	Room Temperature	Pre-warmed with hot water	Pre-warmed in microwave with milk	Room Temperature	Room Temperature
Drinking Temperature	Hot 	Hotter 	Hotter 	Hotter 	Hottest 
Why is there a difference?	A cold ceramic mug will steal heat from the coffee as it warms itself up.	If the mug is already warm, it will not steal as much heat from the coffee.	Just like your cold mug, cold milk lowers the temperature of your coffee.	The Ninja double wall cup is designed to retain initial coffee temp better than a ceramic cup.	Unlike a ceramic mug, a thinner paper cup does not steal substantial heat from the coffee.

PRE-HEATING

- After plugging in or turning your brewer on from power save mode, press the Power Save button to initiate Pre-heating. You will see your pre-heat LED turn on.
- Allow 3 minutes for your brewer to pre-heat.
- After 3 minutes, the light will turn off. Your brewer has now pre-heated.
- Your Ninja Coffee Bar will in stay pre-warmed mode unless you put the brewer into power save mode by pressing the Power Save Button.

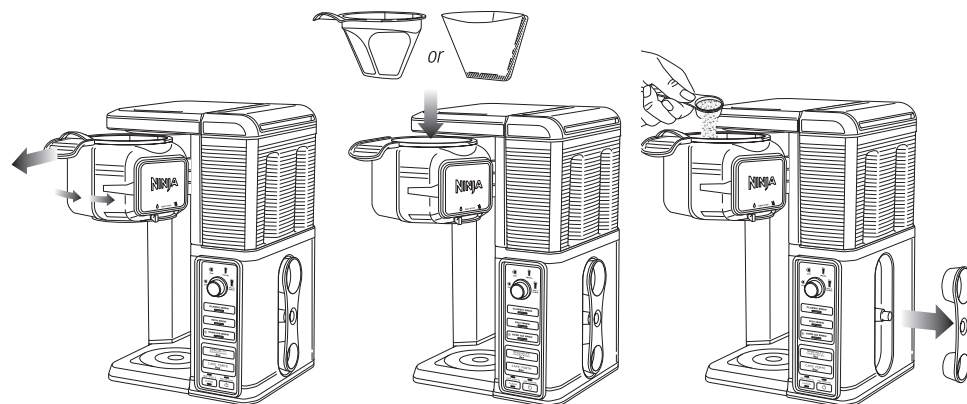
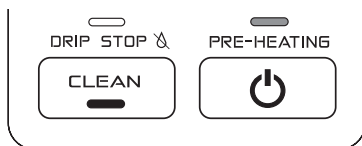

Fig. 7

Fig. 8

Fig. 9

FILLING THE BREW BASKET WITH COFFEE

For best results, use the below measurements of ground coffee for each size brew—the amount of ground coffee for each size will remain the same for any brew type that you select. For example, if you select Cup and Classic Brew, you will use the same amount of coffee grounds as if you select Cup and Over Ice Brew.

CAUTION: The maximum capacity for ground coffee is 6 rounded tablespoons or 3 Ninja Big Scoops. Exceeding this amount or using fine ground coffee may cause overflow.

- Open the brew basket by sliding it out of the brewer. (Fig. 7)

NOTE: Check for any loose grounds that may be left in the brew basket. Remove and rinse the brew basket if needed.

- Place the Premium permanent filter or a #2 paper cone filter in the brew basket. If using a paper filter, first ensure the Premium permanent filter is removed from the brew basket. Then fold a #2 paper cone filter along the seams and insert firmly into the brew basket. (Fig. 8)

- Use the Ninja Scoop and follow the measurements in the chart to fill the filter. These measurements are based on level scoops—adjust to your preferred taste.

(Fig. 9) We suggest using a medium grind size if grinding whole beans.

Serving Size	Ninja® Scoop	Tablespoons
Cup / XL Cup	2–3 small scoops	2–3 Tbsp.
Travel Mug / XL Multi-Serve	2–3 big scoops	4–6 Tbsp.
Signature Brews	Ninja® Scoop	Tablespoons
Specialty (4oz. Brew)	2 big scoops	4 Tbsp.
Cafe Forte (8oz. Brew)	2 big scoops	4 Tbsp.

NOTE: Exceeding the recommended medium grind size for whole beans may cause the brew basket to overflow.

- Slide the brew basket back into the brewer and click in place.

Preparing and using the Ninja Coffee Bar® - cont.

- ⚠ **CAUTION: HOT WATER** Do not remove the brew basket or vessel while brewing.
- ⚠ **CAUTION: STEAM** Do not touch steam vents or the top of the brewer while brewing.
- ⚠ **CAUTION:** The brew basket is hot after brewing. Always allow the brewer to cool down before cleaning.



Fig. 10

DRIP STOP

NOTE: If the Drip Stop is closed before you begin a brew, the brewer will notify you with 5 beeps and the Drip Stop light will be illuminated. Set the Drip Stop to the open position and select your brew concentration level.

NOTE: If you forget to open the Drip Stop, the Ninja Coffee Bar will pause the brew, and after 20 seconds it will give you a friendly audible reminder. After 6 minutes the brew will be canceled.

CAN'T WAIT FOR THE LAST FEW DROPS?

When the brew cycle is complete, set the Drip Stop to the closed position to stop dripping from the brew basket. (Fig. 10)

NOTE: While the Drip Stop is closed the Drip Stop indicator will light up in the bottom left hand corner of the control panel.

NOTE: Remember to open the Drip Stop when you're ready to brew again. If you forget, your Ninja Coffee Bar will give you a friendly audible reminder.

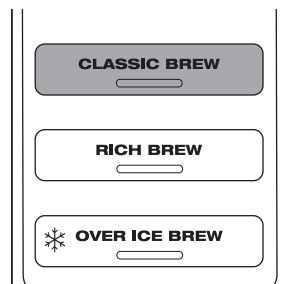

Fig. 11

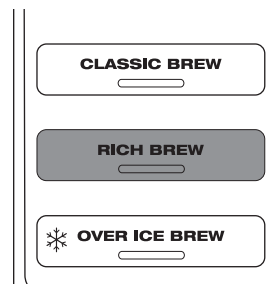

Fig. 12

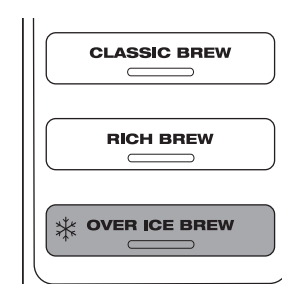

Fig. 13

BREWING COFFEE

NOTE: Each brew has a pre-infusion cycle with varying times. The brew will begin, stop, and be quiet for a short period of time before it begins again. This process is used to evenly saturate your coffee grounds.

NOTE: For a hotter coffee, rinse the coffee cup or mug with hot water prior to brewing.

⚠ **CAUTION:** Ensure the cup or travel mug is completely empty before starting a brewing cycle. Starting a brewing cycle with coffee in the cup or travel mug will cause an overflow.

CUSTOM BREWS: CLASSIC, RICH OR OVER ICE BREW

Classic Brew - For a smooth, balanced flavor.

Rich Brew - For a coffee that is richer than Classic Brew and still smooth, with more room for milk and cream.

- 1 After filling the water reservoir and adding ground coffee to the filter, be sure that the reservoir, basket, and filter are securely in place.
- 2 Use the Multi-Serve dial to select the size of coffee you would like to brew.

Lower the Multi-Serve Cup Platform down and center the cup or mug on the platform. Please ensure that you are using at least 12 oz. cup for the cup size, 14 oz. cup for the XL Cup size, 16 oz. travel mug for the travel mug size and 20 oz. travel mug for the XL Multi-Serve size.

- 3 Press the CLASSIC BREW or the RICH BREW button and the brew will begin. (Fig. 11, Fig. 12) Press the CLASSIC BREW or RICH BREW button again to cancel the brew.

NOTE: The brew will begin, stop, and be quiet for a short period of time before it begins again. This process is used to evenly saturate your coffee grounds.

NOTE: Do not remove water reservoir, brew basket, or vessel while brewing.

- 4 The Ninja Coffee Bar will beep to signal a completed brew.

NOTE: Rich Brew will use slightly less water and yield slightly less brewed coffee than Classic Brew.

OVER ICE BREW

Designed to brew hot coffee over ice to lock in the flavor for a rich, freshly brewed, smooth iced coffee without becoming watered down. Be sure your cup or mug is filled with ice before brewing.

⚠ **CAUTION: DO NOT USE GLASSWARE.**

- 1 After filling the water reservoir, add ground coffee to the filter (feel free to add more coffee if you like a stronger taste). Be sure that the reservoir, basket, and filter are securely in place.
- 2 Use the Multi-Serve dial to select the size of coffee that you would like to brew.
- 3 Before brewing, fill your cup or mug to the top with ice cubes and place it on the cup platform or the base of the brewer below the brew basket. Press the OVER ICE BREW button the brew will begin. (Fig. 13) Press the OVER ICE BREW button again to cancel the brew.

IMPORTANT: Always fill your cup or mug to the top with ice before placing it below the brew basket. Do not add ice to the water reservoir.

NOTE: The brew will begin, stop, and be quiet for a short period of time before it begins again. This process is used to evenly saturate your coffee grounds.

- 4 The Ninja Coffee Bar® will beep to signal a completed brew. Stir to cool coffee completely.

⚠ **CAUTION:** Make sure to use the proper cup size, to prevent coffee overflowing the cup.

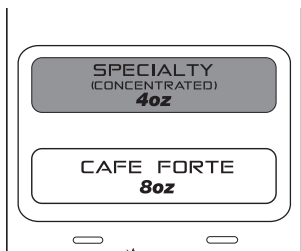

Fig. 14

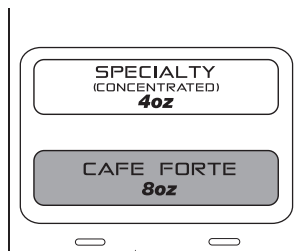

Fig. 15

CAUTION: DO NOT reach across top of brewer to froth during brewing. Steam is released from vent on top of brewer and can result in a steam burn.

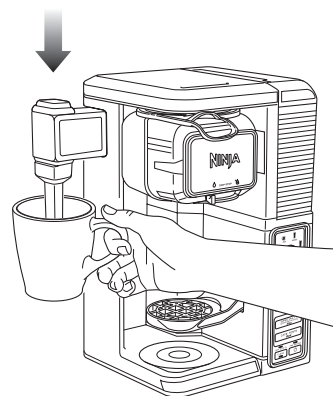

Fig. 16

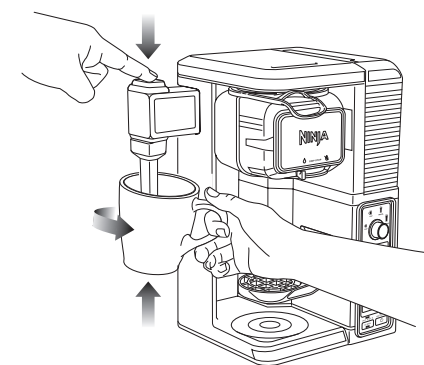

Fig. 17

NINJA SIGNATURE BREWS

Specialty and Cafe Forte brews deliver a specific amount of concentrated coffee for the perfect brew every time. Specialty delivers approximately 4 oz. and Cafe Forte delivers approximately 8 oz.

SPECIALTY AND CAFE FORTE BREW

The Specialty Brew delivers a strong coffee concentrate perfect for an iced blended coffee drink or milk-based specialty drink.

Cafe Forte has a deep, full-bodied, and complex flavor that is rich and drinkable. It tastes great black—no milk or sweeteners needed. Refer to the Inspiration Guide for recipes.

- 1 After filling the water reservoir and adding ground coffee to the filter, be sure that the reservoir, basket, and filter are securely in place.

Note: If brewing an iced blended drink, fill your cup or mug with the amount of ice recommended in the recipe before brewing.

- 2 If using a standard cup or mug, fold out the platform and set vessel on the cup platform. If using a Travel mug or XL Multi-Serve Tumbler, place on the base of the brewer underneath the brew basket. Press the SPECIALTY BREW button or CAFE FORTE button and the brew will begin. (Fig. 14, Fig. 15) Press the SPECIALTY button or CAFE FORTE button again or press the Power Save button to cancel the brew.

NOTE: The brew will begin, stop, and be quiet for a short period of time before it begins again. This process is used to evenly saturate your coffee grounds.

NOTE: No matter which size is selected on the Multi-Serve dial, Specialty will always brew 4 oz. and Cafe Forte will always brew 8 oz.

- 3 The Ninja Coffee Bar will beep to signal a completed brew.

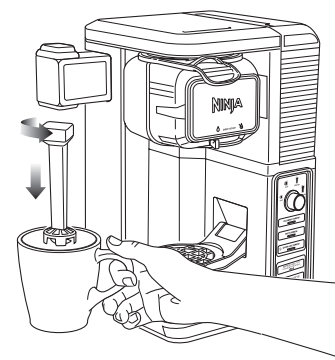

Fig. 18

FROTHING YOUR MILK

- 1 Pour milk into cup, until it is about one-third full. (Use more or less milk depending on your preference.) Microwave for 40 to 60 seconds for hot milk.
- 2 Move the frother into the ready position by swinging the arm toward the front.
- 3 Hold cup under the frother and submerge the whisk just below the surface of the milk. This allows air to fold into the milk, for the frothiest results. (Fig. 16)
- 4 Press and hold the frothing button for 30 to 45 seconds. (Fig. 17)
- 5 You can easily remove the frother whisk by twisting it clockwise. Keep your cup below the whisk and carry it to your sink or dishwasher for cleaning. (Fig. 18)

CLEANING AFTER A BREW

⚠ CAUTION: Make sure that the brewer is unplugged from the power source before cleaning.

⚠ CAUTION: Be sure to allow the brewer to cool before cleaning.

NOTE: Do not leave water in or underneath the water reservoir unused for multiple days. Rinse and replace with fresh water.

- 1 Before cleaning, close the Drip Stop.
- 2 After each brew is complete and the coffee grounds have cooled, carefully remove the Premium permanent filter and wash. If using a paper filter, simply discard. Remove brew basket from the brewer, rinse and wash with soap and warm water.
- 3 After each froth, rinse thoroughly or place the frother whisk on top rack of dishwasher.

NOTE: The swinging brew basket is not dishwasher safe.

NOTE: The flip-top reservoir lid is not dishwasher safe.

NOTE: If coffee grounds spilled over into the brew basket or in the overflow channels, remove and rinse under water until grounds are removed.

- 4 Wipe machine down with a warm cloth with soap and water to clean the base plate, shower head, the water reservoir shelf, the water reservoir, flip-top water reservoir lid, Premium permanent filter, and the removable filter holder. The water reservoir, Premium permanent filter and removable filter holder are dishwasher safe. **Do not immerse the base in water.**

CLEANING & DESCALING YOUR BREWING SYSTEM

⚠ CAUTION: Be sure to allow the brewer to cool before wiping down any surface for cleaning.

⚠ CAUTION: DO NOT immerse the coffeemaker into water or any other liquid.

The CLEAN button will illuminate when a cleaning cycle is recommended for your Ninja Coffee Bar® Single-Serve System, as calcium scale buildup could be affecting the flavor of your coffee.

To clean and descale your Ninja Coffee Bar Single-Serve System:

- 1 Set the container beneath the brew basket and select the brew size for that container.
- 2 Use a descaling solution specifically formulated for coffeemaker cleaning and follow the directions on the package. Fill the water reservoir up to, but not exceeding, the Max Fill line (50 oz.)

OR

Fill the water reservoir to the Travel Mug line (16 oz.) with white vinegar, then fill the rest of the reservoir with water up to, but not exceeding, the Max Fill line (50 oz.).

IMPORTANT: Use only white vinegar.

- 3 Once the water reservoir is filled with your cleaning solution and water mixture, press the CLEAN button. (Fig. 19)

NOTE: To cancel the clean cycle, press the Power button or CLEAN button once. The unit will beep, and stop brewing through the cleaning mixture. Discard any remaining cleaning mixture in the reservoir and the container, and thoroughly clean each. Refill the reservoir with fresh water up to, but not exceeding, the Max Fill line, and set an empty vessel beneath the brew basket. Brew through the entire water reservoir to remove any cleaning solution that could affect the flavor of your coffee.

IMPORTANT: If you cancel the clean cycle, your machine will not be properly descaled, and the CLEAN indicator light will remain on.

- 4 Your Ninja Coffee Bar will distribute some of the cleaning solution, and then pause for 15 minutes. Upon completion, the unit will beep three times.

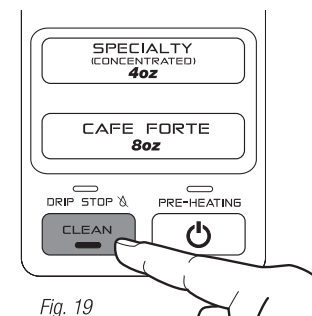

Fig. 19

⚠ CAUTION: DO NOT remove the container at any time throughout the clean cycle.

- 5 Empty and return the vessel under the brew basket.
- 6 Press the CLEAN button. The unit will deliver more of the cleaning solution. At the end of each water delivery cycle, your Ninja Coffee Bar® will beep three times to indicate that the water delivery cycle is over.
- 7 Repeat steps 5 and 6 until the water reservoir is empty. Your Ninja Coffee Bar will beep five times when complete, and the CLEAN light will turn off.
- 8 Empty and thoroughly clean the vessel and water reservoir with warm, soapy water to remove any cleaning solution that could affect the flavor of your coffee.
- 9 Flush the system by filling the water reservoir up to, but not exceeding, the Max Fill line with fresh water only. Then run any brew size on Classic Brew until the water reservoir is empty.

NOTE: If the CLEAN light illuminates again, then calcium scale buildup is still present. Repeat the steps above and the CLEAN light will automatically shut off when your brewer is clean.

Please call Customer Service at 1-877-646-5288 to purchase descaling solution or if the brewer needs any servicing.

CLEANING YOUR WATER RESERVOIR

- 1 Empty the water reservoir.
- 2 Hand wash with dish soap and rinse, or place on the top rack of your dishwasher.
- 3 Clean the water reservoir shelf with cloth and warm soapy water.

CLEANING THE FROTHER

- 1 Separate Frother Whisk from Arm.
Hand-washing: Wash the Frother Whisk in warm soapy water. Handle Frother Whisk with care.
Dishwasher: The Frother Whisk is dishwasher safe. Please place on top rack of dishwasher.

Troubleshooting Guide

PROBLEMS	POSSIBLE REASONS & SOLUTIONS
Sediment in my coffee.	If there is sediment at the bottom of the brewed coffee, this may be due to using finely ground coffee in the Premium permanent filter. To reduce the amount of sediment in the brewed coffee use a slightly coarser grind or use a paper filter.
Grounds in my coffee.	If there are grounds in your coffee, check to make sure the brew basket did not overflow. If there are too many grounds in the brew basket, or you are using a fine ground coffee, the grounds will flow into an overflow channel designed to make sure overflow is captured in the brew vessel. For best results use medium ground coffee in the recommended measurements.
Brew basket dripping after brew.	Check to see if the Drip Stop is set to the closed, no-drip position.
Paper filter falling over.	The Ninja Coffee Bar® is designed to take a #2 cone filter. Be sure you are using this size and shape for best results. Be sure the paper filter is firmly pressed into the brew basket. Wet the corners of the filter for best results. If problem persists, try using the Premium permanent filter.
Coffee is not hot enough.	To keep your coffee hotter longer, pre-heat your mug by rinsing it with hot water from the tap. If using a microwave safe mug with cream or milk, try pre-heating the cream or milk in the microwave for 30 seconds.
Over Ice Brew is not cold.	The Over Ice Brew is designed to brew hot coffee over ice to lock in the flavor for rich, smooth iced coffee. Make sure your cup or travel mug is filled all the way to the top with ice cubes.
Weak coffee.	If the coffee tastes weak, try adding more coffee grounds into the brew basket for the next brew cycle. If the coffee is still weak after adding more coffee grounds, try Rich Brew to make a stronger, more concentrated cup.
Coffee too strong.	Try using a coarser grind. If the coffee is still too strong, try using less coffee grounds.
Brew will not start.	Make sure Power Save button light is illuminated. Check to make sure the brewer is plugged in and water is in the water reservoir. If the Drip Stop is in the open position, check that the brew basket is pushed all the way into the brewer. If you hear 5 beeps, check that the Drip Stop is in the open position. NOTE: The brew will begin, stop, and be quiet for a short period of time before it begins again. This process is used to evenly saturate your coffee grounds.
Brew cycle is too slow.	A single-cup brew will take approximately 4 minutes. If the brew cycle is taking longer than normal, run the Clean Cycle with the descaling solution.

PROBLEMS	POSSIBLE REASONS & SOLUTIONS
My cup or travel mug overflowed.	The cup or travel mug may not have been empty prior to brewing. The water exceeded the Max Fill line on the water reservoir prior to brewing. The Ninja Coffee Bar® is designed to dispense the following amounts on Classic brew: Cup 9.5 oz. XL Cup 11.5 oz. Travel Mug 14 oz. XL Multi-Serve 18 oz. Please ensure that you are using at least a 12 oz. cup for the cup size, 14 oz. cup for the XL Cup size, 16 oz. travel mug for the travel mug size and 20 oz. travel mug for the XL Multi-Serve size. NOTE: On Rich Brew and Over Ice Brew there will be less volume dispensed. Specialty Brew will deliver approximately 4 oz. and Cafe Forte will deliver approximately 8 oz.
Brew basket overflowed.	Check the amount of coffee or type of grind used.
My water reservoir is leaking.	If water was filled above the Max Fill line, water may overflow from the overflow hole at the top of the hand grip. Remove the water reservoir from the brewer and empty to the Max Fill line.
Water left in my reservoir.	Ninja Coffee Bar allows you to fill the reservoir up to but not exceeding the Max Fill line and Auto-iQ® One-Touch Intelligence will only use the water needed for the brew size and style selected. After a brew you may notice leftover water in your water reservoir after filling to the minimum fill line of the size selected. The water reservoir markings are minimum fill lines that indicate if there is enough water for the proper brew size in the reservoir, but all brew styles use different amounts of water to create the proper flavor and concentration. You can brew multiple cups before needing to refill.
Does it take coffee pods?	This brewer is designed to brew coffee grounds only. Do not insert pods or K-Cups®.
My Ninja Coffee Bar is leaking.	If the leak is coming from the brew basket, be sure all the parts are fit securely in the brewer. If the leak is coming from the bottom of the brewer call customer service at 1-877-646-5288.
My Ninja Coffee Bar beeped and did not complete the full brew that I selected.	Ensure the water reservoir is locked in place and is filled with enough water for the desired brew. Check the CLEAN indicator light. If illuminated, run a Clean Cycle with the appropriate descaling solution or a white vinegar mixture. See Care & Maintenance section. Check the Drip Stop indicator light. If illuminated, ensure the brew basket is fully inserted into the brewer and open the Drip Stop once the vessel is placed under the brew basket. If the problem persists, please call customer service at 1-877-646-5288.
Why is the second cup that I brewed hotter than the first cup?	Once the Ninja Coffee Bar has brewed the first cup, the brewing system is pre-warmed. This enables any following brews to be slightly hotter. For a hot first cup, try pre-warming your mug. Or after plugging in or turning on your brewer from Power Save mode, allow 3 minutes for your brewer to preheat.

*K-Cup is a registered trademark of Keurig Green Mountain, Inc. Use of the K-Cup trademark does not imply any affiliation with or endorsement by Keurig Green Mountain, Inc.

Replacement Parts

ORDERING REPLACEMENT PARTS

To order additional parts and attachments, please visit ninjaaccessories.com or feel free to contact customer service: **1-877-646-5288**.

ONE (1) YEAR LIMITED WARRANTY

SharkNinja Operating LLC warrants this product to be free from material defects and workmanship for a period of one (1) year from the date of purchase when utilized for normal household use, subject to the following conditions, exclusions and exceptions.

The liability of **SharkNinja Operating LLC** is limited solely to the cost of the repair or replacement of the unit at our option. This Limited Warranty does not cover normal wear of parts and does not apply to any unit that has been tampered with or used for commercial purposes. This Limited Warranty does not cover damage caused by misuse, abuse, negligent handling or damage due to faulty packaging or mishandling in transit. This Limited Warranty does not cover damage or defects caused by or resulting from damages from shipping or from repairs, service or alteration to the product or any of its parts, which have been performed by a repair person not authorized by **SharkNinja Operating LLC**.

If your appliance fails to operate properly while in use under normal household conditions within the warranty period, return the complete appliance and accessories, freight prepaid. For assistance with warranty service options or customer support, please call our customer care and product specialists at 1 (877) 646-5288 or visit ninjakitchen.com/warranty.

If the appliance is found to be defective in material or workmanship, **SharkNinja Operating LLC** will repair or replace it free of charge. Proof of purchase is required and a fee of \$19.95 will apply to cover the cost of return freight.*

This Limited Warranty is extended to the original purchaser of the unit and excludes all other legal, implied and/or conventional warranties. The responsibility of **SharkNinja Operating LLC**, if any, is limited to the specific obligations expressly assumed by it under the terms of this Limited Warranty. In no event is **SharkNinja Operating LLC** liable for incidental or consequential damages to anyone of any nature whatsoever. Some states do not permit the exclusion or limitation of incidental or consequential damages, so the above may not apply to you.

This Limited Warranty gives you specific legal rights, and you may also have other rights which vary from state to state or from province to province.

***IMPORTANT: Carefully pack item to avoid damage in shipping. Be sure to include proof of purchase date and to attach tag to item before packing with your name, complete address and phone number with a note giving purchase information, model number and what you believe is the problem with the item. We recommend you insure the package (as damage in shipping is not covered by your Limited Warranty). Mark the outside of your package “ATTENTION CUSTOMER SERVICE”.**

Product Registration

Please visit registeryourninja.com or call 1-877-646-5288 to register your new Ninja® product within ten (10) days of purchase. You will be asked to provide the store name, date of purchase and model number along with your name and address.

The registration will enable us to contact you in the unlikely event of a product safety notification. By registering, you acknowledge to have read and understood the instructions for use and warnings set forth in the accompanying instructions.



SharkNinja Operating LLC

US: Needham, MA 02494

CAN: Ville St-Laurent, QC H4S 1A7

1-877-646-5288

ninjakitchen.com

Copyright © 2017 SharkNinja Operating LLC

For SharkNinja U.S. Patent information visit sharkninja.com/USPatents.

Auto-iQ, Ninja, Ninja Coffee Bar and Thermal Flavor Extraction are registered trademarks of SharkNinja Operating LLC.

Printed in China

Illustrations may differ from actual product. We are constantly striving to improve our products, therefore the specifications contained herein are subject to change without notice.

CF111_30_IB_170921_1



@ninjakitchen