

NINJA

COFFEE BAR®

CF080

OWNER'S GUIDE



ninjakitchen.com

1-877-646-5288

IMPORTANT SAFEGUARDS

For Household Use Only

READ ALL INSTRUCTIONS BEFORE USING YOUR NINJA COFFEE BAR®.

Safety Signal Words

This manual and the safety labels attached to this appliance utilize signal words that signify safety hazards with different levels of severity.

Below are the words used and the definitions for these words:

- **WARNING** indicates a hazardous situation which, if not avoided, could result in death or serious injury.
- **CAUTION** indicates a hazardous situation which, if not avoided, could result in minor or moderate injury.
- **NOTICE** is used to address practices not related to physical injury.

The words “**WARNING**” and “**CAUTION**” are preceded by a triangle signifying that these are safety related.

The terms “**IMPORTANT**” and “**NOTE**” are also used to describe good ideas for better and more efficient equipment use.

WARNING:

To reduce the risk of fire, electric shock, serious injury, death or damage when using this appliance, follow these basic safety precautions.

General Precautions

- 1 Do not allow the appliance to be used by children. Close supervision is necessary when used near children. This is not a toy.
- 2 To reduce the risk of electric shock, this appliance has a polarized plug (one blade is wider than the other). As a safety feature, this plug will fit into a polarized outlet only one way. If the plug does not fit fully into the outlet, reverse the plug. If it still does not fit, contact a qualified electrician. Do not force into outlet or try to modify to fit.
- 3 To protect against electrical shock, do not submerge the appliance or allow the power cord to come into contact with water or any other liquid.
- 4 Allow the appliance to cool before taking off parts and before cleaning.
- 5 Do not abuse the power cord. Never carry the appliance by the power cord or yank it to disconnect from electrical outlet; instead grasp the plug and pull to disconnect.
- 6 Do not operate any appliance with a damaged cord or plug, or after the appliance malfunctions, has been dropped or damaged in any manner.
- 7 Do not let the power cord hang over the edge of table or counter or touch hot surfaces such as the stove.
- 8 Do not remove the brew basket or carafe while the appliance is brewing. **Scalding may occur if any of these parts are removed during brewing cycles.**

THIS BOOK COVERS MODEL NUMBER:

CF080

TECHNICAL SPECIFICATIONS

Voltage: 120V~, 60Hz.

Power: 1450 Watts

Water Reservoir

Capacity: 43 Ounces



- 9 The use of an accessory not recommended by the manufacturer may result in fire, electric shock, create an overflow condition and scalding hazard or personal injury.
- 10 Do not operate your appliance in an appliance garage or under a wall cabinet. When storing in an appliance garage always unplug the unit from the electrical outlet. Not doing so could create a risk of fire, especially if the appliance touches the walls of the garage or the door touches the unit as it closes.

Operating Notice

- 11 Clogging and backing up of water and/or coffee in the filter basket can occur under any or a combination of any of the following conditions: The use of too finely ground coffee, using two or more paper filters, using the permanent filter in conjunction with a paper filter, not cleaning coffee grounds from the permanent filter, or allowing coffee grounds to spill over the filter.
- 12 Always use appliance on a dry, level surface.
- 13 Do not use this appliance for anything other than its intended use. Do not use outdoors.
- 14 Do not touch hot surfaces. Use handles or knobs.
- 15 Do not touch warming plate while the brewer is in use.

Glass Carafe

- 16 The carafe is designed for use with this appliance. It must never be used on a range top.
- 17 Do not set a hot carafe on a wet or cold surface.
- 18 Do not use a cracked or scratched carafe or a carafe having a loose or weakened handle.
- 19 Do not clean carafe with abrasive cleansers, steel wools pads, or other abrasive material.
- 20 Do not place carafe in microwave.

- 21 Do not expose carafe to extreme temperature changes.
- 22 Do not place on or near a hot gas or electric burner or in a heated oven.
- 23 Do not use for carbonated beverages.
- 24 Do not drink directly from the carafe! Liquid from the carafe may be very hot!
- 25 Do not use the carafe to store any other type of food when not in use.
- 26 Ensure that the carafe is completely empty before starting a cleaning or brewing cycle. Starting a cycle with water or coffee in the carafe will cause an overflow.

Maintenance

- 27 Remove the power cord from the electrical outlet, allow to cool before removing brew basket, water reservoir, or filters and before surface cleaning.
- 28 Clean the glass carafe with a soft brush or sponge. Do not use a wire brush.
- 29 To prevent illness from bacterial growth in the appliance, follow all cleaning instructions in the "Care & Maintenance" section of this owner's guide.
- 30 If the product is not operating properly contact SharkNinja Operating LLC at 1-877-646-5288 or ninjakitchen.com for examination, repair or adjustment.
- 31 Clean the system on a weekly basis.

Cord Statement

- 32 A short power-supply cord is provided to reduce the risks resulting from becoming entangled in or tripping over a longer cord.
- 33 Do not use extension cord with this product.

SAVE THESE INSTRUCTIONS



Contents

Thank you for
purchasing the
Ninja Coffee
Bar®.

Getting To Know Your Ninja Coffee Bar®	5
Control Panel	6
Features Of The Ninja Coffee Bar®	7
Before First Use	8
Setting The Clock And Delay Brew	9
Assembly	10
Preparing For Use	12
Filling The Water Reservoir	12
How Much Coffee Do You Get In Your Cup.....	12
Would You Like A Hotter Coffee	13
Filling The Brew Basket With Coffee	13
Drip Stop	14
Intelligent Warming Plate	14
Stay Warm Button	14
Brewing Coffee	15
Classic And Rich Brew.....	15
Over Ice Brew	16
Specialty Brew	16
Care & Maintenance	17
Cleaning After A Brew	17
Cleaning Your Carafe	17
Cleaning Your Water Reservoir	17
Cleaning & Descaling Your Brewing System	18
Troubleshooting Guide.....	19
Replacement Parts.....	21
Warranty & Registration.....	22

Getting To Know Your Ninja Coffee Bar®

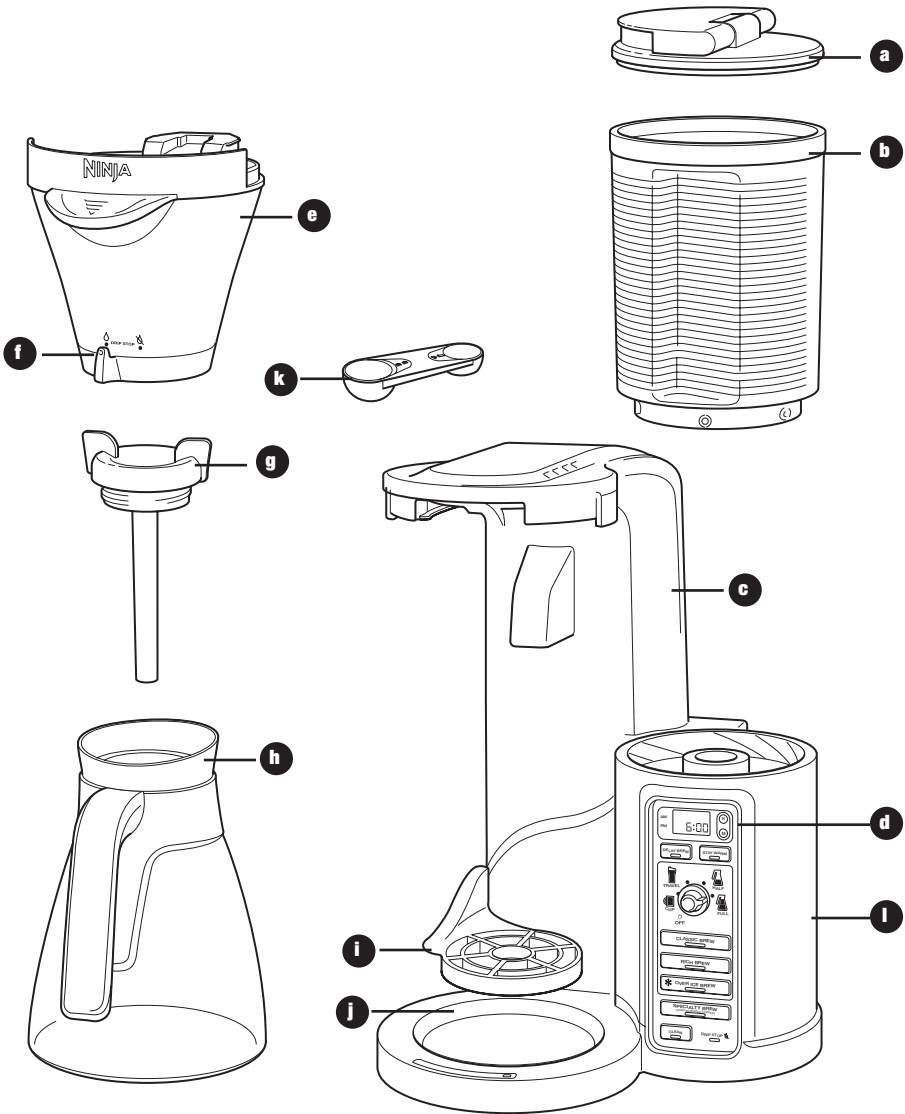

- a** Flip Top Water Reservoir Lid
- b** Removable Water Reservoir
- c** Brewer
- d** Control Panel
- e** Removable Brew Basket
- f** Drip Stop Toggle
- g** Brew-Through Carafe Lid
- h** Glass Carafe
- i** Multi-Serve Cup Platform
- j** Intelligent Warming Plate
- k** Double Sided Scoop: Carafe Side and Single Serve Side
- l** Power Cord & Wrap (not shown)



Control Panel

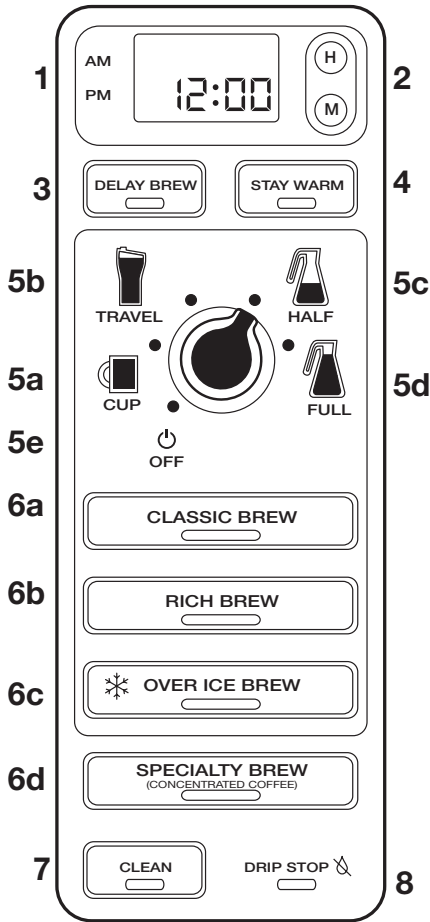

- 1 Programmable Digital Clock
- 2 Clock Hour and Minute Buttons
- 3 Delay Brew Button
- 4 Stay Warm Button
- 5 Multi-Serve Dial
 - a Cup
 - b Travel Mug
 - c Half Carafe
 - d Full Carafe
 - e Off - Turns off all functions except the clock
- 6 Brew Types
 - a Classic Brew Button
 - b Rich Brew Button
 - c Over Ice Brew Button
 - d Specialty Brew Button
- 7 Intelligent Clean Cycle Indicator/Button
- 8 Drip Stop Indicator

Features of the Ninja Coffee Bar®

- **Thermal Flavor Extraction® Technology** - Blends Precision Water Delivery with automated controls for Calibrated Temperature, Pre-infusion, Coffee Saturation, and Flavor Richness. Ninja's Thermal Flavor Extraction technology can truly unlock the full flavor potential of your coffee.
- **Multi Serve** – Ability to brew directly into your favorite cup, travel mug, or carafe.
- **Brew Types** – Control the strength and style of your coffee:
 - a. Classic Brew for smooth, balanced hot coffee.
 - b. Rich Brew for a richer-than-classic and still smooth coffee with more room for milk and cream.
 - c. Over Ice Brew for smooth, rich, freshly brewed iced coffee that's not watered down.
 - d. Specialty Brew for a strong extract for specialty milk based drinks or blended iced drinks.
- **Multi Serve Cup Platform** – Pull it down and place your favorite cup on it and brew directly into it.
- **Removable Water Reservoir with Easy Access Flip Top Lid** – For quick and easy filling.
- **Auto-iQ®** – The Ninja Coffee Bar® knows how much water to use for each size and brew type.
- **43 oz Glass Carafe**
- **LED Control Panel with Programmable Digital Clock**
- **24-HR Programmable Delay Brew Button** – Set it to automatically brew the following morning.
- **Drip Stop** – Stops the flow of coffee from the brew basket allowing you to pour a cup mid-brew; switch toggle to the closed position to prevent dripping once the brew cycle is finished.
- **Clean Function** – It illuminates when your Ninja Coffee Bar senses that there is hard water calcium build up in your brewer which can affect the flavor of your coffee. When it illuminates, follow the cleaning instructions in the Care & Maintenance section or printed on the back of your brewer.
- **Stay Warm Button** – Your warming plate will automatically turn on after brewing a carafe and turn off after 2 hours. The Stay Warm button allows you to manually turn the warming plate off.
- **Intelligent Warming Plate** – Automatically adjusts the temperature of the warming plate to keep your coffee at the ideal drinking temperature without burning it.
- **Pre-Heat Mode** – The Ninja Coffee Bar brewer will be in an idle mode keeping the internal water pre-heated for 72 hours.
- **Sleep Mode** – After 72 hours the Ninja Coffee Bar will enter sleep mode to conserve energy or turn the Multi-Serve dial to "OFF" to manually turn off the pre-heat and all other functions.
- **Audible Ready Signal** – Alerts you that your coffee is ready.
- **2 hour shut off** – Automatically turns off the warming plate two hours after you brew coffee.

Multi Serve

Brew into a cup, travel mug, or classic carafe or half carafe.

Cup

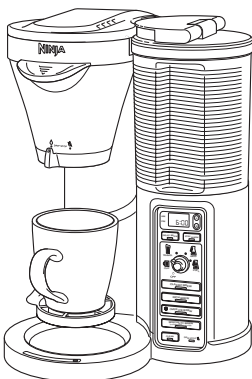

Travel Mug

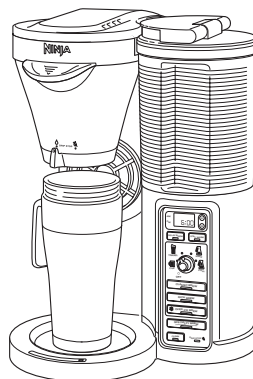

Classic Carafe or Half Carafe

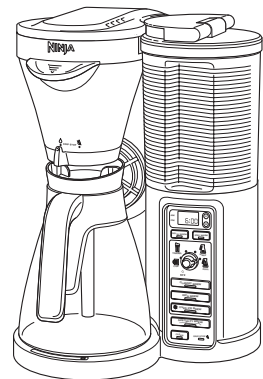

Before First Use

PLEASE KEEP THESE IMPORTANT SAFEGUARDS IN MIND WHEN USING THE APPLIANCE:

- ⚠ CAUTION: APPLIANCE CREATES HOT LIQUID. HANDLE WITH CARE.**
- ⚠ CAUTION: DO NOT** remove the vessel while the appliance is running without the Drip Stop in the closed position. Return the vessel quickly and open the Drip Stop to continue the brew.
- ⚠ CAUTION: Never** open the brew basket when the coffeemaker is in use.
- ⚠ CAUTION: Please** ensure that you are using at least a 12 oz. cup for the Cup size and a 16 oz. travel mug for the Travel mug size to prevent overflow and a scalding injury.

IMPORTANT: DO NOT run the appliance without water.

IMPORTANT: Always place a vessel beneath the brew basket to receive the brewed coffee.

IMPORTANT: DO NOT overfill the water reservoir, fill water only to the Max Fill line.

- 1** Remove all packaging material, stickers and labels from the brewer.

NOTE: The glass carafe is dishwasher safe. Place on top rack only.

- 2** Wash the water reservoir, glass carafe and brew basket in warm, soapy water with a soft cloth.
- 3** Rinse and dry thoroughly.
- 4** Wipe the intelligent warming plate with a damp cloth.
- 5** Before first use, run two full carafe cycles with water only and discard water.

Setting the Clock & Delay Brew



Fig. 1

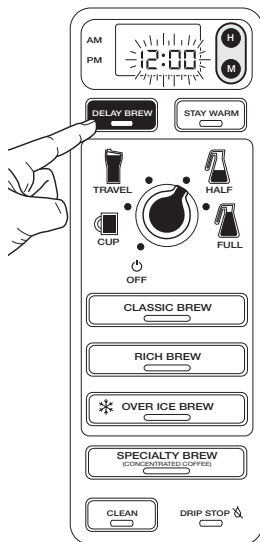

Fig. 2



Fig. 3

TO SET THE CLOCK

- 1 Plug the power cord into an electrical outlet. The clock will flash on the control panel to indicate that the time has not been set. **(Fig. 1)**
- 2 Press the H (hour) or M (minute) button until you reach the current time. The AM or PM indicator will illuminate on the left side of the display as you are setting the time. **(Fig. 2)**
- 3 After 5 seconds the clock will stop flashing and the clock will be set.

NOTE: If the clock stops flashing and does not display the correct time of day, pressing the H (hour) or the M (minute) button at any time will cause the clock to flash again. You can now re-program the correct time of day by following the steps above.

NOTE: If you unplug the brewer or in the event of an extended power loss, you will need to reset the clock the next time the brewer is plugged in.

TO SET THE DELAY BREW TIME

NOTE: The Ninja Coffee Bar® must remain on in order for the delay brew function to work. Do not power off after setting Delay Brew.

- 1 Press Delay Brew. The Delay Brew button will illuminate and the clock will begin to flash "12:00" or the last delay brew time that was set. **(Fig. 2)**
- 2 While the clock is flashing, press the H (hour) or M (minute) button to set the time that you would like the delay brew to begin. The AM or PM indicator will illuminate on the left side of the display as you are setting the desired time.

- 3 Once the proper time has been set, select the size of the vessel that you would like to brew.
- 4 Select the Brew Type that you desire from the 4 flashing buttons. The selected brew type will be lit. **(Fig. 3)**
- 5 Once the time, brew size, and brew type have been set, allow the Delay Brew to flash and lock in or press the Delay Brew button to activate the Delay Brew. When the Delay Brew is activated, the light on the Delay Brew button will illuminate and an audible signal will play to verify the Delay Brew is set.
- 6 The Delay Brew time is now set and your Ninja Coffee Bar will automatically brew at the time you programmed.

NOTE: To deactivate the Delay Brew cycle, press the Delay Brew button once more and the light on the Delay Brew button will turn off. Any change to the selected brew size or starting any other brew will cancel the programmed Delay Brew.

- 7 Place the appropriate-sized vessel under brew basket for the selected size.

IMPORTANT: Make sure the Drip Stop is in the open position.

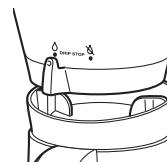

Go to ninjakitchen.com for more information and how-to videos.

Assembly

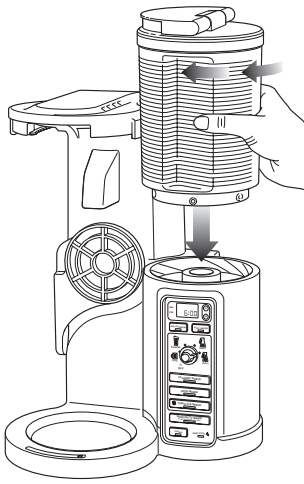

Fig. 4

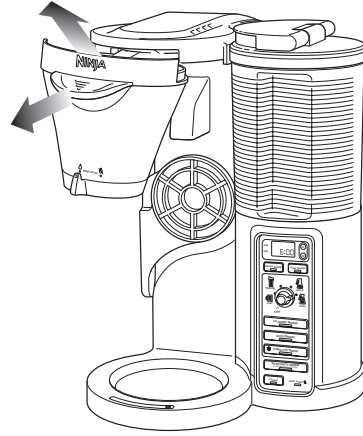

Fig. 5

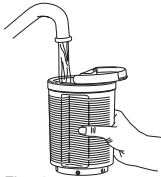

Fig. 4a

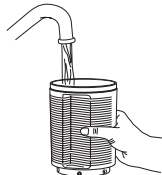

Fig. 4b

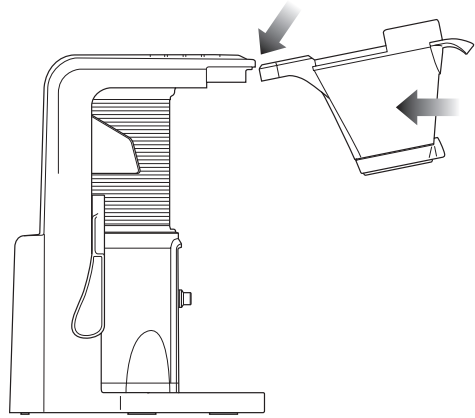

Fig. 6

- 1 Place the brewer on a dry, clean and level surface.
- 2 Holding the water reservoir by the grip, twist counterclockwise to remove. **(Fig. 4)** Either flip the lid top over **(Fig. 4a)** or remove lid by twisting counterclockwise to remove **(Fig. 4b)**. Fill with water up to, but not exceeding the carafe line (43 oz. Max Fill line). To replace the water reservoir, place on top of the base and twist clockwise until a click indicates it is locked in place.
- 3 Slide brew basket out and angle up slightly to remove it from the brewer. **(Fig. 5)** To reinsert, align the brew basket with the rails and slide back into the brewer. **(Fig. 6)**
- 4 Once the brew basket is in place, slide all the way into place until you hear a slight click.

Assembly - cont.

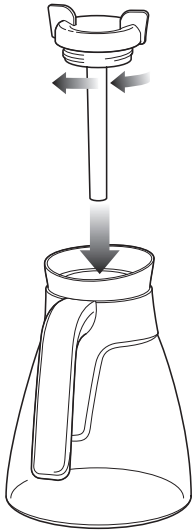

Fig. 7

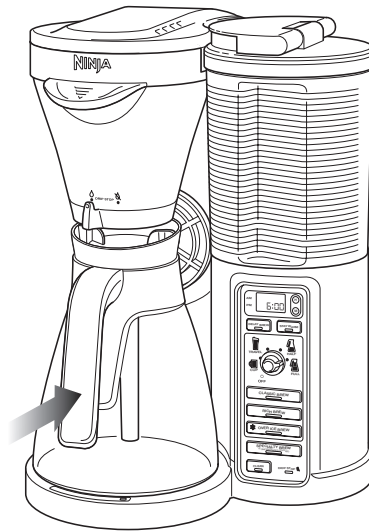

Fig. 8

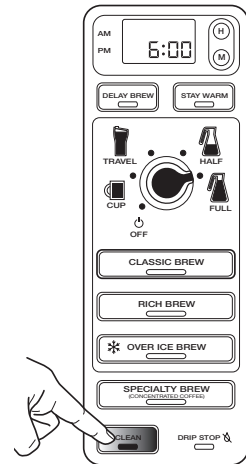

Fig. 9

- 5 Twist the brew-through lid clockwise onto the glass carafe to lock into place. **(Fig. 7)**
- 6 Center the carafe below the brew basket. **(Fig. 8)**
NOTE: Do not use any coffee for the first two brew cycles in order to clean the brewer.
- 7 Plug the brewer into an electrical outlet.
- 8 Once all parts are securely in place, press the Clean button to thoroughly clean the machine before first use. **(Fig. 9)**
- 9 Discard the water in the carafe and repeat, beginning with step 2, with one more clean cycle of water before first use.

Preparing for Use

- ⚠ CAUTION:** Only fill water reservoir up to, but not exceeding the Max Fill line with water; we recommend fresh, cool, filtered water. Do not fill water reservoir with any other liquids such as brewed coffee, carbonated beverages, etc. as other liquids may damage your brewer.

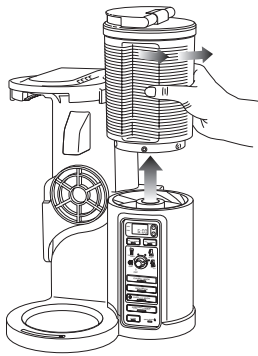

Fig. 10

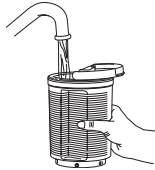

Fig. 11a

OR

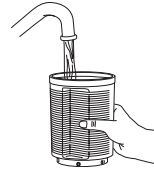

Fig. 11b

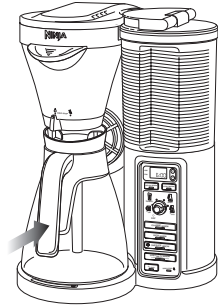

Fig. 12

FILLING THE WATER RESERVOIR

- For easy filling, remove the water reservoir by slightly twisting counterclockwise until it is free from the brewer. (Fig. 10)
- Either flip the lid top over or remove lid by twisting counterclockwise to remove. (Fig. 11a, Fig. 11b)
- For best results, fill the water reservoir with fresh, cool, filtered water. Ensure that the water is above the minimum fill line for the brew size that is selected. Do not exceed the Max Fill line. The machine's intelligence will automatically measure the amount of water needed. To avoid refilling after each cup, fill to the carafe line.

NOTE: The water reservoir and water reservoir lid can lock in multiple locations.

NOTE: Do not fill past the Max Fill line. If overfilled, remove the water reservoir from the brewer and empty to the Max Fill line.

Depending on the size and brew type, you may have water left in the reservoir.

- Place the water reservoir back on the brewer and twist clockwise until you feel the reservoir lock into place.
- Place the vessel that you would like to brew into underneath the brew basket—ensure that the vessel is centered under the brew basket. (Fig. 12)

NOTE: After removing the water reservoir, there may be a small amount of water in the reservoir valve. This can be easily removed with a dry cloth.

HOW MUCH COFFEE DO YOU GET IN YOUR CUP?

Each size and brew type produces a different amount of coffee to optimize strength, taste, and size.

NOTE: The coffee grounds will absorb some of the water that is brewed, resulting in slightly less brewed coffee than water used.

⚠ CAUTION: Please ensure that you are using at least a 12 oz. cup for the Cup size and a 16 oz. travel mug for the Travel mug size.

Approximate Brew Volume





Size/Brew	Classic	Rich	Specialty
Cup	9.5 oz.	8.8 oz.	3.1 oz.
Travel Mug	14 oz.	13.2 oz.	4 oz.
Half Carafe	21 oz.	19.5 oz.	5 oz.
Full Carafe	38 oz.	35.5 oz.	10 oz.

Size/Brew	Over Ice	
	Coffee Only	With Ice
Cup	3.7 oz.	9.5 oz.
Travel Mug	5.8 oz.	14 oz.
Half Carafe	10.5 oz.	21 oz.
Full Carafe	15.8 oz.	38 oz.

Preparing for Use - cont.

WOULD YOU LIKE A HOTTER COFFEE?

Have you ever wondered why you get paper cups on the go? The type of cup you brew into can drastically influence the drinking temperature!

CUP TYPE	CERAMIC CUP		NINJA® CUP	PAPER CUP
Cup Temperature	Room Temp	Pre-warmed with hot water	Pre-warmed in microwave with milk	Room Temp
Drinking Temperature	Hot 	Hotter 	Hotter 	Hotter 
Why is there a difference?	A cold ceramic mug will steal heat from the coffee as it warms itself up.	If the mug is already warm, it will not steal as much heat from the coffee.	Just like your cold mug, cold milk lowers the temperature of your coffee.	The Ninja® double wall cup is designed to retain initial coffee temp better than a ceramic cup.
				Unlike a ceramic mug, a thinner paper cup does not steal substantial heat from the coffee.

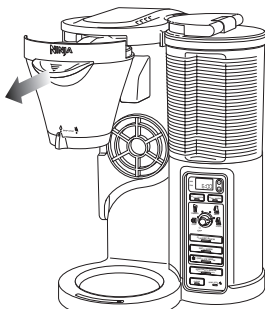

Fig. 13

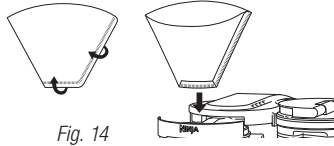

Fig. 14

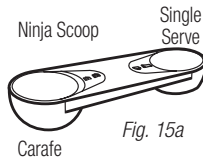

Fig. 15a

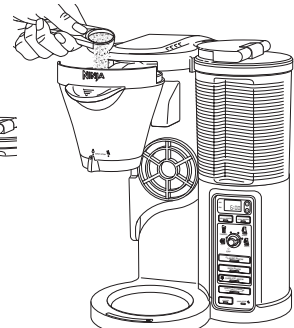

Fig. 15

FILLING THE BREW BASKET WITH COFFEE

For best results, use the below measurements of ground coffee for each size brew—the amount of ground coffee for each size will remain the same for any brew type that you select. For example, if you select Cup and Classic Brew, you will use the same amount of coffee grounds as if you select Cup and Specialty Brew.

⚠ CAUTION: The maximum capacity for ground coffee is 12 rounded tablespoons or 6 Ninja Carafe Scoops. Exceeding this amount or using fine ground coffee may cause overflow.

- 1 Open the brew basket by sliding the brew basket out of the brewer. (Fig. 13)

NOTE: The brew basket can be removed from the brewer by lifting the brew basket at a slight upward angle (similar to a cabinet drawer).

NOTE: Check for any loose grounds that may be left in the brew basket. Remove and rinse brew basket if needed.

- 2 Using a #4 paper cone filter, fold along the seams, open it fully, and firmly press it into the brew basket making sure that it is fully seated. (Fig. 14)

- 3 Use the Ninja Scoop (Fig. 15a) and follow the measurements below to fill the paper filter. These measurements are based on level scoops—adjust to your preferred taste. (Fig. 15) We suggest using a medium grind size if grinding whole beans.

Single Serve	Ninja® Scoop (Single Serve Side)	Tablespoon
Cup	2–3 scoops	2–3 Tbsp.
Travel Mug	3–4 scoops	3–4 Tbsp.
Carafe	Ninja® Scoop (Carafe Side)	Tablespoon
Half Carafe	2–3 scoops	5–7 Tbsp.
Full Carafe	4–6 scoops	8–12 Tbsp.

NOTE: Exceeding the recommended medium grind size for whole beans and 6 Ninja Carafe Scoops may cause the brew basket to overflow.

- 4 Slide the brew basket back into the brewer and click in place.

- ⚠ **CAUTION: HOT WATER.** Do not remove the brew basket or vessel while brewing.
- ⚠ **CAUTION: STEAM.** Do not touch steam vents or the top of the brewer while brewing.
- ⚠ **CAUTION:** The brew basket is hot after brewing. Always allow the brewer to cool down before cleaning.

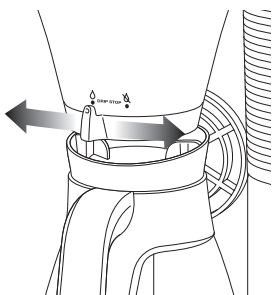

Fig. 16

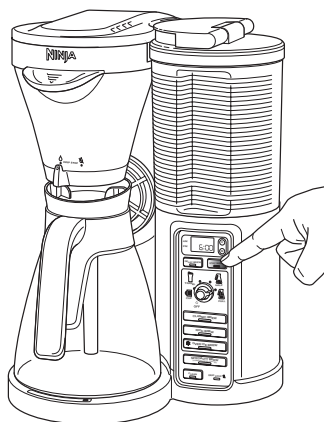

Fig. 17

DRIP STOP

NOTE: If the Drip Stop is closed before you begin a brew, the brewer will notify you with 5 beeps. Set the Drip Stop to the open position and select your brew concentration level.

CAN'T WAIT FOR THAT FIRST CUP TO BE READY?

When brewing a carafe, close the Drip Stop to pause the brew cycle and pour a cup. Remember to reopen the Drip Stop to complete the brew. (Fig. 16)

NOTE: If you forget to open the Drip Stop, the Ninja Coffee Bar® will pause the brew, and after 20 seconds it will give you a friendly audible reminder. After 6 minutes the brew will be canceled.

CAN'T WAIT FOR THE LAST FEW DROPS?

When the brew cycle is complete, set the Drip Stop to the closed position to stop dripping from the brew basket.

NOTE: While the Drip Stop is closed the Drip Stop indicator will light up in the bottom right hand corner of the control panel.

NOTE: Remember to open the Drip Stop when you're ready to brew again. If you forget, your Ninja Coffee Bar will give you a friendly audible reminder.

INTELLIGENT WARMING PLATE

The Intelligent Warming Plate will automatically turn on after a Classic or Rich on Carafe or Half Carafe. The Intelligent Warming Plate will adjust the heat it produces in order to avoid burning the coffee over time.

⚠ **CAUTION:** The **HOT SURFACE** light will illuminate when the warming plate is hot. Do not touch the surface when this light is illuminated.

STAY WARM BUTTON

Press the Stay Warm Button after the brew to turn the Intelligent Warming Plate off. You can turn the Intelligent Warming Plate back on within 2 hours of the brew by pressing the stay warm button again if desired. (Fig. 17)

If you would like the Warming Plate to stay on longer, you can program it to stay on up to 4 hours.

- 1 Turn the Multi-Serve dial to half carafe or full carafe.
- 2 Press and hold Stay Warm until the clock begins to flash the current time the warming plate will stay on for.
- 3 Quickly press the hour or minute (H or M) to increase the time up to 4 hours.
- 4 The time will lock in after 5 seconds or you can press the Stay Warm button.

Preparing for Use- cont.

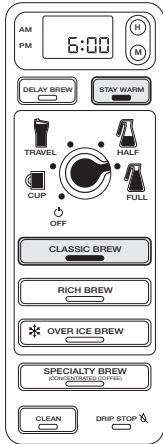

Fig. 18

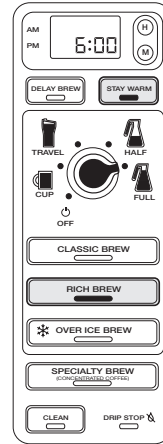

Fig. 19

BREWING COFFEE

NOTE: Each brew has a pre-infusion cycle with varying times. The brew will begin, stop, and be quiet for a short period of time before it begins again. This process is used to evenly saturate your coffee grounds.

NOTE: For a hotter coffee, rinse the coffee cup, mug or glass carafe with hot water prior to brewing.

CAUTION: Ensure the carafe is completely empty before starting a brewing cycle. Starting a brewing cycle with coffee in the carafe will cause an overflow.

CLASSIC OR RICH BREW

Classic Brew - For a smooth, balanced flavor.

Rich Brew - For a coffee that is richer than Classic Brew and still smooth, with more room for milk and cream.

- 1 After filling the water reservoir and adding ground coffee to the filter, be sure that the Drip Stop is open and the reservoir, basket, and filter are securely in place.
- 2 Use the multi-serve dial to select the size of coffee you would like to brew. Place the empty vessel that you would like to brew into underneath the brew basket.

NOTE: If making a single cup, lower the multi-serve cup platform down and center the cup or mug on the cup platform. Please ensure that you are using at least a 12 oz. cup for the cup size and a 16 oz. travel mug for the travel mug size.

- 3 Press the Classic Brew or the Rich Brew button and the brew will begin. (Fig. 18, Fig. 19) Press the Classic or Rich button again or turn the Multi-Serve Size dial to Off to cancel the brew.

NOTE: The brew will begin, stop, and be quiet for a short period of time before it begins again. This process is used to evenly saturate your coffee grounds.

NOTE: If brewing a half carafe or a full carafe, the Stay Warm indicator and Intelligent Warming Plate will automatically turn on. (Fig. 18, Fig. 19) This can be turned off by pressing the Stay Warm button once illuminated. The Intelligent Warming Plate will turn off automatically after 2 hours.

NOTE: Do not remove water reservoir, brew basket, or vessel while brewing.

- 4 The Ninja Coffee Bar® will beep to signal a completed brew.

NOTE: Rich Brew will use slightly less water and yield slightly less brewed coffee than Classic Brew.

OVER ICE BREW

Designed to brew hot coffee over ice to lock in the flavor for a rich, freshly brewed, smooth iced coffee without becoming watered down. Be sure your vessel is filled with ice before brewing.

⚠ CAUTION: DO NOT USE GLASSWARE.

- 1 After filling the water reservoir, add ground coffee to the filter (feel free to add more coffee if you like a stronger taste), be sure that the Drip Stop is open, reservoir, basket, and filter are securely in place.
- 2 Use the multi-serve dial to select the size of coffee that you would like to brew.
- 3 Before Brewing, fill the desired vessel to the top with ice cubes and place the vessel below the brew basket. Press "Over Ice Brew" and the brew will begin. (Fig. 20) Press the Over Ice button again or turn the Multi-Serve Size dial to Off to cancel the brew.

IMPORTANT: Always fill the desired vessel to the top with ice before placing it below the brew basket. Do not add ice to the water reservoir.

NOTE: The brew will begin, stop, and be quiet for a short period of time before it begins again. This process is used to evenly saturate your coffee grounds.

NOTE: If making a Carafe of Over-Ice-Brew fill the carafe with ice and brew without the brew-through lid.

- 4 The Ninja Coffee Bar® will beep to signal a completed brew. Stir to cool coffee completely.

NOTE: When brewing coffee in the Over Ice Brew, the Intelligent Warming Plate will not turn on.

APPROXIMATE BREW VOLUME

⚠ CAUTION: Make sure to use the proper cup size, not doing so may lead to coffee overflowing the cup.

Size/Brew	Over Ice	
	Coffee Only	With Ice
Cup	3.7 oz.	9.5 oz.
Travel Mug	5.8 oz.	14 oz.
Half Carafe	10.5 oz.	21oz.
Full Carafe	15.8 oz.	38 oz.

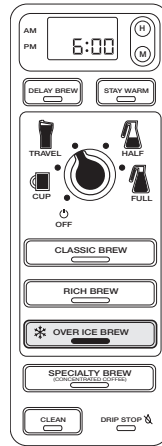

Fig. 20

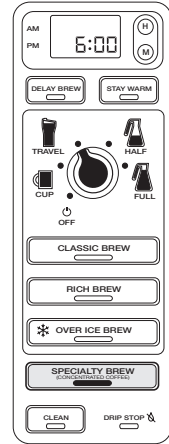

Fig. 21

SPECIALTY BREW

The Specialty Brew delivers a strong coffee concentrate perfect for an iced blended coffee drink or milk based specialty drink. Refer to the Let's Get Started Guide for inspiring recipes.

- 1 After filling the water reservoir and adding ground coffee to the filter, be sure that the Drip Stop is open, reservoir, basket, and filter are securely in place.
- 2 Use the multi-serve dial to select the size of coffee that you would like to brew.

NOTE: If brewing an iced blended drink, fill the desired vessel with the amount of ice recommended in the recipe before brewing.

- 3 Place the vessel that you would like to brew into underneath the brew basket. Press "Specialty Brew" and the brew will begin. (Fig. 21) Press the Specialty button again or turn the Multi-Serve Size dial to Off to cancel the brew.

NOTE: The brew will begin, stop, and be quiet for a short period of time before it begins again. This process is used to evenly saturate your coffee grounds.

NOTE: If brewing a half carafe or a full carafe, the Intelligent Warming Plate will not turn on.

- 4 The Ninja Coffee Bar will beep to signal a completed brew.

Go to ninjakitchen.com for more information and how-to videos.

Care & Maintenance

CLEANING AFTER A BREW

⚠ CAUTION: Make sure that the brewer is unplugged from the power source before cleaning.

⚠ CAUTION: Be sure to allow the brewer to cool before cleaning.

IMPORTANT: Discontinue use if the glass carafe is scratched or handle is loose or damaged.

NOTE: Do not leave coffee in the glass carafe for an extended period of time after a brew.

NOTE: Do not leave water in the reservoir unused for multiple days. Rinse and replace with fresh water.

- 1 Before cleaning, close the Drip Stop.
- 2 After each brew is complete and the coffee grounds have cooled, carefully remove the paper filter and discard. Remove brew basket from the brewer, rinse and wash with soap and warm water.

NOTE: The brew basket is not dishwasher safe.

NOTE: If coffee grounds spilled over into the brew basket or in the overflow channels, remove and rinse under water until grounds are removed.

- 3 Wash the carafe and brew-through lid with soap and warm water. Use a bottle brush or a cloth to wash the inside of the carafe.

NOTE: The brew-through lid, glass carafe and water reservoir are top shelf dishwasher safe.

IMPORTANT: Clean the glass carafe with a soft brush or sponge. Do not use a wire brush.

- 4 Wipe machine down with a warm cloth with soap and water. Let the warming plate cool before cleaning with a wet cloth and soap and water. **Do not immerse the base in water.**

NOTE: For best results, use a bottle brush. This will allow you to scrub all of the inside with soap and hot water.

CLEANING YOUR CARAFE

We recommend rinsing your carafe with warm soapy water, or placing in the top shelf of your dishwasher.

If you want to clean the carafe more thoroughly, we recommend using a soft foam brush such as the one shown.



CLEANING YOUR WATER RESERVOIR

- 1 Empty the water reservoir.
- 2 Hand wash with dish soap and rinse or place on the top rack of your dishwasher.

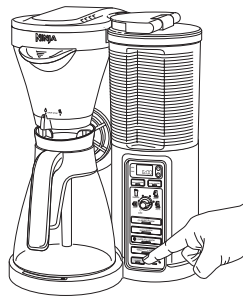

Fig. 22

CLEANING & DESCALING YOUR BREWING SYSTEM

⚠ CAUTION: Be sure to allow the brewer to cool before wiping down any surface for cleaning.

⚠ CAUTION: DO NOT immerse the coffeemaker into water or any other liquid.

The CLEAN button will illuminate when a cleaning cycle is recommended for your Ninja Coffee Bar®, as calcium scale buildup could be affecting the flavor of your coffee.

To clean and descale your Ninja Coffee Bar:

NOTE: The clean cycle takes approximately 60 minutes.

- 1 Select the Full Carafe size and set the empty carafe beneath the brew basket.
- 2 Use a descaling solution specifically formulated for coffeemaker cleaning and follow the directions on the package. Fill the water reservoir up to, but not exceeding, the Max Fill line (43 oz.).

OR

Fill the water reservoir to the Travel Mug line (16 oz.) with white vinegar, then fill the rest of the reservoir with water up to, but not exceeding, the Max Fill line (43 oz.).

IMPORTANT: Use only white vinegar.

- 3 Once the water reservoir is filled with your cleaning solution and water mixture, press the CLEAN button. (Fig. 22)

NOTE: To cancel the clean cycle, turn the multi-serve dial to the 'OFF' position or press the CLEAN button once. The unit will beep, and stop brewing through the cleaning mixture. Discard any remaining cleaning mixture in the reservoir and the carafe, and thoroughly clean each. Refill the reservoir with fresh water up to, but not exceeding, the Max Fill line, and set the empty carafe beneath the brew basket. Run a Full Carafe, Classic Brew with water only to remove any cleaning solution that could affect the flavor of your coffee.

IMPORTANT: If you cancel the clean cycle, your machine will not be properly descaled, and the CLEAN indicator light will remain on.

- 4 The clock will display and countdown the remaining clean cycle time, as this takes approximately 60 minutes to complete. Your Ninja Coffee Bar will deliver a small amount of cleaning solution to distribute it through the system. It will then pause for a half an hour, deliver additional cleaning solution, and pause for another half hour. The extended pauses allow for maximum cleaning and descaling.

⚠ CAUTION: DO NOT remove the carafe at any time throughout the clean cycle.

- 5 Upon completion, the brewer will beep, and the CLEAN light will turn off.
- 6 Empty and thoroughly clean the carafe and water reservoir with warm, soapy water to remove any cleaning solution that could affect the flavor of your coffee.
- 7 Fill the reservoir with fresh water up to, but not exceeding, the Max Fill line (43 oz.) and set the empty carafe beneath the brew basket.
- 8 Flush the system by running a Full Carafe, Classic Brew cycle with water only. After the cycle is complete, discard the water and thoroughly clean the carafe to remove any cleaning solution that could affect the flavor of your coffee.

NOTE: If the CLEAN light illuminates again, then calcium scale buildup is still present. Repeat the steps above and the CLEAN light will automatically shut off when your brewer is clean.

Please call Customer Service at 1-877-646-5288 to purchase descaling solution or if the brewer needs any servicing.

Troubleshooting Guide



PROBLEMS	POSSIBLE REASONS & SOLUTIONS
<p>My Ninja Coffee Bar® beeped and did not complete the full brew that I selected.</p>	<p>Ensure the water reservoir is locked in place and is filled with enough water for the desired brew.</p> <p>Check the CLEAN indicator light. If illuminated, run a clean cycle with the appropriate descaling solution or a white vinegar mixture. See Care & Maintenance section.</p> <p>Check the Drip Stop indicator light. If illuminated, ensure the brew basket is fully inserted into the brewer and open the Drip Stop once the vessel is placed under the brew basket.</p> <p>If the CLEAN cycle was run and the Ninja Coffee Bar is still not completing the brew OR the CLEAN light is flashing, you may have hard water and a critical amount of calcium build up.</p> <p>If the problem persists please call customer service at 1-877-646-5288.</p>
<p>My CLEAN button is flashing and beeping. The clock is flashing cln.</p>	<p>The Ninja Coffee Bar senses that there is a critical amount of calcium or mineral deposits built up in the internal parts of the brewer. Run a clean cycle using a Descaling solution or a white vinegar solution. Please see the Care & Maintenance section on page 18.</p>
<p>Sediment in my coffee.</p>	<p>If there is sediment at the bottom of the brewed coffee, this may be due to finely ground coffee in a permanent filter.</p> <p>To reduce the amount of sediment in the brewed coffee use a slightly coarser grind or use a paper filter.</p>
<p>Grounds in my coffee.</p>	<p>If there are grounds in your coffee, check to make sure the brew basket did not overflow.</p> <p>If there are too many grounds in the brew basket, or you are using a fine ground coffee, the grounds will flow into an overflow channel designed to make sure overflow is captured in the brew vessel. For best results use medium ground coffee in the recommended measurements.</p>
<p>Brew Basket dripping after brew.</p>	<p>Check to see if the Drip Stop toggle is set to the closed, no drip position.</p> <p>If the Drip Stop is set to the closed, no drip position and the brewer continues to drip, run a clean cycle or wash the brew basket thoroughly with warm, soapy water.</p>
<p>Paper filter falling over.</p>	<p>The Ninja Coffee Bar is designed to take a #4 cone filter. Be sure you are using this size and shape for best results.</p> <p>Be sure the paper filter is firmly pressed into the brew basket.</p> <p>Wet the corners of the filter for best results.</p> <p>If problem persists, try using a permanent filter.</p>
<p>Coffee is not hot enough.</p>	<p>Your Ninja Coffee Bar System is equipped with a pre-heating function that ensures your cup of coffee as hot as it possibly can be. After turning your Ninja Coffee Bar on, the pre-heat notification will illuminate for 3 minutes as it warms up. Once it has warmed up to temperature the pre-heat notification will turn off indicating it is time to brew.</p> <p>To brew the hottest possible cup with your Ninja Coffee Bar, keep it plugged in and powered on at all times to allow the brewing system to remain warm and ready to brew.</p>
<p>Over Ice Brew is not cold.</p>	<p>The Over Ice Brew is designed to brew hot coffee over ice to lock in the flavor for rich, smooth iced coffee. Make sure your cup, travel mug, or carafe is filled all the way to the top with ice cubes.</p>
<p>Weak coffee.</p>	<p>If the coffee tastes weak, try adding more coffee grounds into the brew basket for the next brew cycle.</p> <p>If the coffee is still weak after adding more coffee grounds, try Rich Brew to make a stronger more concentrated cup.</p>



PROBLEMS	POSSIBLE REASONS & SOLUTIONS								
Coffee too strong.	<p>Try using a more coarse grind.</p> <p>If the coffee is still too strong, try using less coffee grounds.</p>								
Brew will not start.	<p>Check to make sure the brewer is plugged in and water is in the water reservoir.</p> <p>If the drip stop is in the open position, check that the brew basket is pushed all the way into the brewer.</p> <p>If you hear 5 beeps, check that the drip stop is in the open position.</p> <p>NOTE: The brew will begin, stop, and be quiet for a short period of time before it begins again. This process is used to evenly saturate your coffee grounds.</p>								
Brew cycle is too slow.	<p>A carafe brew will take approximately 8 minutes and the single cup will take approximately 4 minutes.</p> <p>If the brew cycle is taking longer than normal, run the clean cycle with the descaling solution.</p>								
My cup, travel mug or carafe overflowed.	<p>The cup, travel mug or carafe may not have been empty prior to brewing.</p> <p>The water exceeded the Max Fill line on the water reservoir prior to brewing.</p> <p>The Ninja Coffee Bar® is designed to dispense the following amounts on classic brew:</p> <table border="0" data-bbox="362 713 553 812"> <tr> <td>Cup</td> <td>9.5 oz</td> </tr> <tr> <td>Travel Mug</td> <td>14 oz</td> </tr> <tr> <td>Half Carafe</td> <td>21 oz</td> </tr> <tr> <td>Carafe</td> <td>38 oz</td> </tr> </table> <p>Please ensure that you are using at least a 12 oz. cup for the cup size and a 16 oz. travel mug for the travel mug size.</p> <p>NOTE: On Rich Brew, Over Ice Brew, and Specialty Brew there will be less volume dispensed.</p>	Cup	9.5 oz	Travel Mug	14 oz	Half Carafe	21 oz	Carafe	38 oz
Cup	9.5 oz								
Travel Mug	14 oz								
Half Carafe	21 oz								
Carafe	38 oz								
Brew basket overflowed.	<p>Check the amount of coffee or type of grind used.</p>								
Water left in my reservoir.	<p>Ninja Coffee Bar allows you to fill the reservoir up to but not exceeding the Max Fill line and Auto-iQ® One Touch Intelligence will only use the water needed for the brew size and style selected.</p> <p>After a brew you may notice left over water in your water reservoir after filling to the minimum fill line of the size selected. The water reservoir markings are minimum fill lines that indicate if there is enough water for the proper brew size in the reservoir for any brew style in that size, but all brew styles use different amounts of water to create the proper flavor and concentration.</p> <p>You can brew multiple cups before needing to refill.</p>								
Does it take coffee pods?	<p>This brewer is designed to brew coffee grounds only. Do not insert pods or K-Cups®*.</p>								
My Ninja Coffee Bar® is leaking.	<p>If the leak is coming from the brew basket, be sure all the parts are fit securely in the brewer.</p> <p>If the leak is coming from the bottom of the brewer call customer service at 1-877-646-5288.</p>								

*K-Cup is a registered trademark of Keurig Green Mountain, Inc. Use of the K-Cup trademark does not imply any affiliation with or endorsement by Keurig Green Mountain, Inc.

Troubleshooting Guide - cont.

PROBLEMS	POSSIBLE REASONS & SOLUTIONS
<p>Why is the second cup that I brewed hotter than the first brew?</p>	<p>Once the Ninja Coffee Bar® has brewed the first cup, the brewing system is pre-warmed. This enables any following brews to be slightly hotter. For a hot first cup try pre-warming your mug.</p>
<p>How long does pre-heat take to give me the hottest cup?</p>	<p>After turning your Ninja Coffee Bar on, the pre-heat notification will illuminate for 3 minutes as it warms up. Once it has warmed up to temperature the pre-heat notification will turn off indicating it is time to brew.</p> <p>To brew the hottest possible cup with your Ninja Coffee Bar, keep it plugged in and powered on at all times to allow the brewing system to remain warm and ready to brew.</p>
<p>I noticed the carafe design & lid. What are the benefits?</p>	<p>Our unique carafe shape and design has the following benefits:</p> <ul style="list-style-type: none"> Easy grip design making it easy to pour coffee without dripping. Thoroughly mix your coffee from the first drop to the last thanks to the Brew-Through Carafe Lid. Optimize coffee temperature. Allow you to brew both hot and iced coffee.
<p>Coffee Brew Volume: What impacts coffee brew volume?</p>	<p>When you make hot coffee, coffee grounds will absorb some of the water that is brewed resulting in slightly less brewed coffee than the water used. The more coffee you use, the more water will be absorbed. Additionally, our wider bottom carafe holds most of the volume coffee at the base which helps control the temperature more evenly.</p> <p>Classic Brew:</p> <div style="display: flex; justify-content: space-around; align-items: center;"> <div style="text-align: center;">  <p>Full Carafe</p> </div> <div style="text-align: center;">  <p>Half Carafe</p> </div> </div>
<p>How does the Ninja Coffee Bar keep coffee at the right temperature?</p>	<p>The carafe is designed to keep most of the coffee volume in the bottom so it can be held closer to the Precise Temp Warming plate. This helps maintain the coffee at the ideal drinking temperature.</p>

Go to ninjakitchen.com for more information and how-to videos.

Replacement Parts

ORDERING REPLACEMENT PARTS

To order additional parts and attachments, please visit our website: ninjaaccessories.com or feel free to contact customer service: 1-877-646-5288.



Shark | NINJA

ONE (1) YEAR LIMITED WARRANTY

SharkNinja Operating LLC warrants this product to be free from material defects and workmanship for a period of one (1) year from the date of purchase when utilized for normal household use, subject to the following conditions, exclusions and exceptions.

The liability of **SharkNinja Operating LLC** is limited solely to the cost of the repair or replacement of the unit at our option. This Limited Warranty does not cover normal wear of parts and does not apply to any unit that has been tampered with or used for commercial purposes. This Limited Warranty does not cover damage caused by misuse, abuse, negligent handling or damage due to faulty packaging or mishandling in transit. This Limited Warranty does not cover damage or defects caused by or resulting from damages from shipping or repairs, service or alteration to the product or any of its parts, which have been performed by a repair person not authorized by **SharkNinja Operating LLC**.

If your appliance fails to operate properly while in use under normal household conditions within the warranty period, return the complete appliance and accessories, freight prepaid. For assistance with warranty service options or customer support, please call our customer care and product specialists at, call 1 (877) 646-5288 or visit our website ninjakitchen.com/warranty.

If the appliance is found to be defective in material or workmanship, **SharkNinja Operating LLC** will repair or replace it free of charge. Proof of purchase is required and a fee of \$19.95 will apply to cover the cost of return freight. *

This Limited Warranty is extended to the original purchaser of the unit and excludes all other legal, implied and/or conventional warranties. The responsibility of **SharkNinja Operating LLC** if any, is limited to the specific obligations expressly assumed by it under the terms of this Limited Warranty. In no event is **SharkNinja Operating LLC** liable for incidental or consequential damages to anyone of any nature whatsoever. Some states do not permit the exclusion or limitation of incidental or consequential damages, so the above may not apply to you.

This Limited Warranty gives you specific legal rights, and you may also have other rights which vary from state to state or from province to province.

***IMPORTANT: Carefully pack item to avoid damage in shipping. Be sure to include proof of purchase date and to attach tag to item before packing with your name, complete address and phone number with a note giving purchase information, model number and what you believe is the problem with the item. We recommend you insure the package (as damage in shipping is not covered by your Limited Warranty). Mark the outside of your package "ATTENTION CUSTOMER SERVICE".**

Product Registration

Please visit registeryourninja.com or call 1-877-646-5288 to register your new Ninja® product within ten (10) days of purchase. You will be asked to provide the store name, date of purchase and model number along with your name and address.

The registration will enable us to contact you in the unlikely event of a product safety notification. By registering you acknowledge to have read and understood the instructions for use, and warnings set forth in the accompanying instructions.



VISIT US ONLINE AT:

www.ninjakitchen.com

Or follow us on any of our social media pages:



fb.me/ninjacoffeebar



youtube.com/ninjacoffeebar



[@ninjacoffeebar](https://twitter.com/ninjacoffeebar)



pinterest.com/ninjakitchen



[@ninjakitchen](https://instagram.com/ninjakitchen)

SharkNinja Operating LLC

US: Needham, MA 02494

CAN: Ville St-Laurent, QC H4S 1A7

1-877-646-5288

ninjakitchen.com

Copyright © 2017 SharkNinja Operating LLC

For SharkNinja U.S. Patent information visit sharkninja.com/USPatents.

Auto-iQ, Ninja, Ninja Coffee Bar, and Thermal Flavor Extraction are registered trademarks of SharkNinja Operating LLC.

Printed in China

Illustrations may differ from actual product. We are constantly striving to improve our products, therefore the specifications contained herein are subject to change without notice.

CF080_69_170510_19