

# NINJA®

## Foodi SMART GRILL

### LG450 Series

### OWNER'S GUIDE



# THANK YOU

for purchasing the Ninja® Foodi® Smart Grill



## REGISTER YOUR PURCHASE

 [registeryourninja.com](http://registeryourninja.com)

 Scan QR code using mobile device

## RECORD THIS INFORMATION

Model Number: \_\_\_\_\_

Serial Number: \_\_\_\_\_

Date of Purchase: \_\_\_\_\_  
(Keep receipt)

Store of Purchase: \_\_\_\_\_

## TECHNICAL SPECIFICATIONS

Voltage: 120V~, 60Hz

Watts: 1760W

**TIP:** You can find the model and serial numbers on the QR code label on the back of the unit by the power cord.

# CONTENTS

<b>Important Safeguards</b> .....	<b>4</b>
<b>Parts</b> .....	<b>6</b>
<b>Getting to Know the Ninja® Foodi® Smart Grill</b> .....	<b>7</b>
Function Buttons .....	7
Operating Buttons .....	7
<b>Before First Use</b> .....	<b>7</b>
<b>Using the Ninja Foodi Smart Grill</b> .....	<b>8</b>
Splatter Shield .....	8
GrillControl Technology .....	8
Batch Grilling .....	8
Using the Foodi Smart Thermometer .....	9
Using the Thermometer in Different Cooking Scenarios ..	10
How to Correctly Insert the Thermometer .....	11
Cooking Functions .....	12
Grill .....	12
Air Crisp .....	13
Roast .....	14
Bake .....	15
Dehydrate .....	16
<b>Cleaning the Ninja Foodi Smart Grill</b> .....	<b>17</b>
<b>Replacement Parts</b> .....	<b>17</b>
<b>Troubleshooting</b> .....	<b>18</b>
<b>Warranty</b> .....	<b>19</b>

# IMPORTANT SAFEGUARDS

HOUSEHOLD USE ONLY • READ ALL INSTRUCTIONS BEFORE USE

When using electrical appliances, basic safety precautions should always be followed, including the following:

## ⚠ WARNING

- 1 To eliminate a choking hazard for young children, discard all packaging materials immediately upon unpacking.
- 2 This appliance can be used by persons with reduced physical, sensory or mental capabilities or lack of experience and knowledge if they have been given supervision or instruction concerning use of the appliance in a safe way and understand the hazards involved.
- 3 Keep the appliance and its cord out of reach of children. **DO NOT** allow the appliance to be used by children. Close supervision is necessary when used near children.
- 4 This appliance is for household use only. **DO NOT** use this appliance for anything other than its intended use. **DO NOT** use in moving vehicles or boats. **DO NOT** use outdoors. Misuse may cause injury.
- 5 Ensure the surface is level, clean and dry. **DO NOT** place the appliance near the edge of a countertop during operation.
- 6 **ALWAYS** ensure the appliance is properly assembled before use.
- 7 When using this appliance, provide at least 6 inches (15.25 cm) of space above and on all sides for air circulation.
- 8 **DO NOT** use an extension cord. A short power-supply cord is used to reduce the risk of children grabbing the cord or becoming entangled and to reduce the risk of people tripping over a longer cord.
- 9 To protect against electrical shock **DO NOT** immerse cord, plugs, or main unit housing in water or other liquid.
- 10 **DO NOT** use the appliance if there is damage to the power cord or plug. Regularly inspect the appliance and power cord. If the appliance malfunctions or has been damaged in any way, immediately stop use and call Customer Service.
- 11 **NEVER** use outlet below countertop surface.
- 12 **DO NOT** place appliance and let cord hang over edges of tables, counters or touch hot surfaces.
- 13 Only use recommended accessories included with this appliance or authorized by SharkNinja. The use of accessories or attachments not recommended by SharkNinja may cause a risk of fire or injury.
- 14 Before placing any accessory into the cooker, ensure they are clean and dry.
- 15 **DO NOT** use the appliance without the removable cooking pot and splatter shield installed.
- 16 **ALWAYS** ensure hood is fully closed before operating.
- 17 **DO NOT** move the appliance when in use.
- 18 **DO NOT** cover the air intake vent or air outlet vent while unit is operating. Doing so will prevent even cooking and may damage the unit or cause it to overheat.
- 19 **DO NOT** touch hot surfaces. Appliance surfaces are hot during and after operation. To prevent burns or personal injury, **ALWAYS** use protective hot pads or insulated oven mitts and use available handles and knobs.

- 20 **DO NOT** touch accessories during or immediately after cooking. The grill grate and basket becomes extremely hot during the cooking process. Avoid physical contact while removing the accessory from the appliance. To prevent burns or personal injury **ALWAYS** use care when interfacing with product. Recommend use of long handed utensil and protective hot pads or insulated oven mitts.
- 21 **DO NOT** use this appliance for deep-frying.
- 22 The Foodi® Smart Thermometer does **NOT** replace an external food thermometer.
- 23 To prevent possible illness, **ALWAYS** use an external food thermometer to check that your food is cooked to the recommended temperatures
- 24 Should a grease fire occur or the unit emits black smoke, unplug immediately. Wait for smoking to stop before removing any cooking accessories.
- 25 Please refer to the Cleaning & Maintenance section for regular maintenance of the appliance.
- 26 To disconnect, turn unit to "off", then unplug from socket when not in use and before cleaning.
- 27 Allow to cool before cleaning, disassembly, putting in or taking off parts and storage.
- 28 **DO NOT** clean with metal scouring pads. Pieces can break off the pad and touch electrical parts, creating a risk of electric shock.
- 29 Cleaning and user maintenance shall not be made by children.
- 30 **DO NOT** place on or near a hot gas or electric burner or in a heated oven.
- 31 Extreme caution must be used when moving an appliance containing hot oil or other hot liquids.



Indicates to read and review instructions to understand operation and use of product.



Indicates the presence of a hazard that can cause personal injury, death or substantial property damage if the warning included with this symbol is ignored.



Take care to avoid contact with hot surface. Always use hand protection to avoid burns.



For indoor and household use only.

## SAVE THESE INSTRUCTIONS

## PARTS

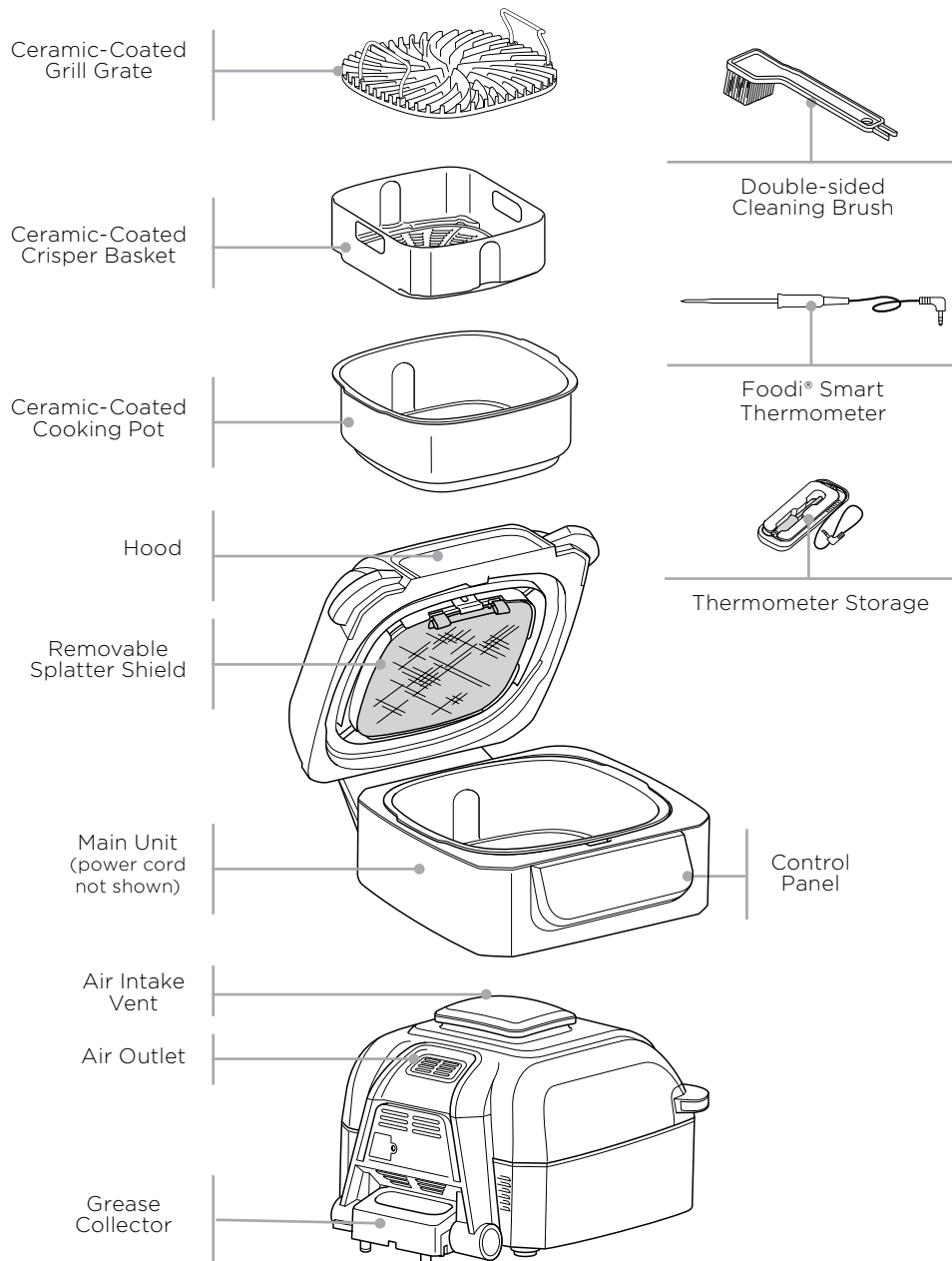

**NOTE:** Additional accessories are available for purchase at [ninjaaccessories.com](http://ninjaaccessories.com).

## GETTING TO KNOW THE NINJA® FOODI® SMART GRILL

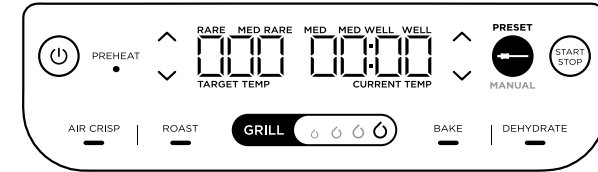

**NOTE:** Not all functions included in each model.

### FUNCTION BUTTONS

**GRILL** Grill indoors while creating even char, grill marks, and grilled flavor.

**AIR CRISP** For crispiness and crunch with little to no oil.

**BAKE** Bake cakes, treats, desserts, and more.

**ROAST** Tenderize meats, roast vegetables, and more.

**DEHYDRATE** Dehydrate meats, fruits, and vegetables for healthy snacks.

### OPERATING BUTTONS

**POWER button** Once the unit is plugged in, press the power button to turn on the unit. Pressing it during cooking stops the current cooking function and turns off the unit.

**Left arrows** Use the up and down arrows to the left of the display to adjust the cooking temperature in any function or to set the internal doneness when using PRESET and MANUAL buttons.

**Right arrows** Use the up and down arrows to the right of the display to set the food type when using PRESET or to adjust the cook time when not cooking with the Foodi Smart Thermometer.

**MANUAL setting** Pressing the thermometer button twice switches the display screen so you can manually set the thermometer internal doneness.

**PRESET setting** Switches the display screen so you can set the thermometer, food type, and internal doneness.

**NOTE:** To adjust the temperature or time during cooking, press the up and down arrows. The unit will then resume at those settings.

**START/STOP button** After selecting temperature and time, press the START/STOP button to begin cooking.

**Standby Mode** If there has been no interaction with the control panel for 10 minutes and the unit is not cooking, the unit will go into Standby Mode and the control panel will dim.

**PREHEAT** If the unit is preheating, it will be indicated by a progress bar on the display screen and the PREHEAT button will illuminate. To turn off Preheat, press the PREHEAT button while the grill is in preheat state. ADD FOOD will display.

## BEFORE FIRST USE

- 1 Remove all packaging material, promotional labels, and tape from the unit.
- 2 Remove all accessories from the package and read this manual carefully. Please pay particular attention to operational instructions, warnings, and important safeguards to avoid any injury or property damage.
- 3 Wash the grill grate, splatter shield, crisper basket, thermometer, cleaning brush, and cooking pot in warm, soapy water, then rinse and dry thoroughly. All accessories, except the thermometer, are dishwasher safe. **NEVER** clean the main unit or thermometer in the dishwasher.

# USING THE NINJA® FOODI® SMART GRILL

## SPLATTER SHIELD

Located on the underside of the hood, the splatter shield keeps the heating element clean. **ALWAYS** ensure the splatter shield is installed when cooking. Failure to use the splatter shield will result in oil buildup on the heating element, which can cause smoking.

### Removing the splatter shield

Remove the splatter shield for cleaning after every use. Once the splatter shield has cooled completely, remove it by pushing the upper left tab toward the back of the hood. This will release the splatter shield, allowing you to remove it.

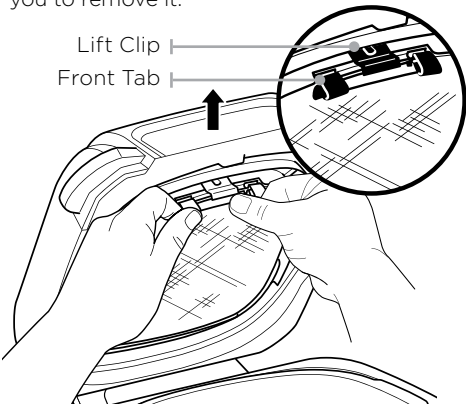

### Installing the splatter shield

To install, insert the splatter shield so the grooves on the splatter shield ring match those of the fixed heat shield ring notch on the right. Then gently push the splatter shield upward until it clicks into the tab on the left side.

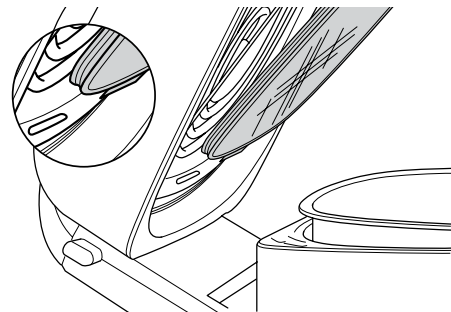

## GRILLCONTROL TECHNOLOGY

When using the Grill function, you will need to select the grill grate temperature setting. Below are recommended temperature levels for common ingredients.

LO (400°F)	MED (450°F)	HI (500°F)	MAX (up to 510°F)
<ul style="list-style-type: none"> <li>• Bacon</li> <li>• Sausages</li> <li>• When using thick BBQ sauce</li> </ul>	<ul style="list-style-type: none"> <li>• Frozen meats</li> <li>• Marinated/ sauced meats</li> </ul>	<ul style="list-style-type: none"> <li>• Steaks</li> <li>• Chicken</li> <li>• Burgers</li> <li>• Hot dogs</li> <li>• Meat kebabs</li> </ul>	<ul style="list-style-type: none"> <li>• Veggies</li> <li>• Fruit</li> <li>• Pizzas</li> <li>• Fresh/ frozen seafood</li> <li>• Veggie Kebabs</li> </ul>

**NOTE:** For less smoke, we recommend using canola, coconut, avocado, grapeseed, or vegetable oil instead of olive oil. Heating oil past its smoke point can impart food with a burnt, acrid flavor.

**NOTE:** The unit may produce smoke when cooking ingredients on a hotter setting than what is recommended. For more cooking charts, refer to your Inspiration Guide or visit [ninjakitchen.com](http://ninjakitchen.com).

### Switching to Grill after using another function

If the unit is already warm from using a different function, "ADD FOOD" may appear on the screen immediately. We recommend allowing the grill grate to heat up for at least 6 minutes before placing ingredients on it.

### Batch grilling

When grilling more than two consecutive batches of food, it is recommended that you empty the fat/oil from the removable cooking pot. It is also HIGHLY recommended to clean the splatter shield in between uses. This will help prevent grease from burning and causing smoke.

If you would like to skip the Preheat process, press the PREHEAT button.

## USING THE FOODI® SMART THERMOMETER

**IMPORTANT:** DO NOT place hands near Foodi Smart Thermometer cord when in use to prevent burning or scalding

### Before First Use

Make sure the thermometer jack is free of any residue and the cord is free of knots before plugging it into the jack.

- 1 Unwind the cord from the magnetic storage compartment to remove the thermometer. **Note: The storage compartment is magnetic and can be placed on either side of the unit.**
- 2 Plug the thermometer into the jack of the right side of the control panel. Push firmly on the plug until it cannot go into the jack any further. Place the storage compartment back onto the side of the unit.
- 3 Once the thermometer is plugged into the jack, it will enable and illuminate PRESET and MANUAL. Select the desired cook function (e.g., Grill) and cook temperature.

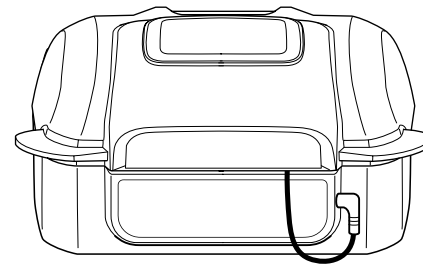

**NOTE:** There is no need to set a cook time, as the unit will automatically turn off the heating element and alert you when your food has finished cooking.

- 4 Press the thermometer button  $\ominus$  to fully illuminate PRESET and use the arrows to the right of the display to select your desired food type and the arrows to the left of the display to set the internal doneness of your food (Rare through Well).

**NOTE:** Cooking different meats or the same ones to different doneness? Refer to the next page for details on programming.



To use the MANUAL function instead of PRESET, press the thermometer button  $\ominus$  again to switch to MANUAL. Use the recommended internal cook temperatures below:

FOOD TYPE:	SET DONENESS TO:
<b>Fish</b>	Medium (130°F)
	Medium Well (140°F)
	Well Done (150°F)
<b>Chicken/Turkey</b>	Well Done (170°F)
<b>Pork</b>	Medium (130°F)
	Medium Well (150°F)
	Well Done (160°F)
<b>Beef/Lamb</b>	Rare (110°F)
	Medium Rare (125°F)
	Medium (130°F)
	Medium Well (145°F)
	Well Done (155°F)

**NOTE:** Set doneness for BEEF/LAMB are lower than normal recommendations as unit will carry-over cook 5-10°F.

**NOTE:** Reference USDA guidelines for food-safe temperature recommendations.

- 5 Place the accessory required (excluding the thermometer) for your selected cook function in the unit and close the hood. Press START/STOP to begin preheating.

# USING THE NINJA® FOODI® SMART GRILL – CONT.

**6** While the unit is preheating, insert the thermometer horizontally into the center of the thickest part of the piece of protein. **Refer to the chart on the adjacent page on further thermometer placement instructions.**

**7** When the unit has preheated and “ADD FOOD” appears on the screen, open the hood, place food with inserted thermometer in the unit, and close the hood over the thermometer cord.

**8** The progress bar at the top of the display will track doneness. Flashing doneness indicates progression to that doneness.

RARE > MED RARE < MED MED WELL WELL

**NOTE:** When using Roast and Grill, the unit will beep and display FLIP. Flipping is optional, but recommended.

**9** The unit will automatically stop when desired doneness is almost reached, as it accounts for carry-over cooking, and “GET FOOD” will display on the screen.



**10** Transfer the protein to a plate while “REST” displays on the screen. Thermometer does not need to still be inserted. The protein will continue to carry-over cook to your set doneness, which will take about 3-5 minutes. This is an important step, as not resting could lead to results looking “less” cooked. Carry-over cook times can vary based on type, cut and size of protein.

**NOTE:** To check the internal temperature of other pieces of protein, press and hold the thermometer button and insert the thermometer into each piece of meat.

**NOTE:** The thermometer will be HOT. Use either oven mitts or tongs to take the thermometer out of the protein.

## USING THE THERMOMETER IN DIFFERENT COOKING SCENARIOS:

### Cooking 2 or more proteins of the same size to different levels of doneness:

- Set the Preset feature to the highest desired level of doneness.
- Insert the thermometer in the protein with the higher desired level of doneness.
- After preheating, place proteins inside the grill. When the lower desired level of doneness is reached, remove the protein without thermometer.
- Continue cooking the remaining protein until the next desired level of doneness is reached.

### Cooking 2 or more proteins of different sizes:

- Insert thermometer in the smaller protein and use the Preset feature to choose the level of doneness.
- When that protein is done cooking, remove it from the unit.
- Using oven mitts, transfer thermometer to the larger protein and use the arrows to the left of the display to choose its level of doneness.

### Cooking 2 or more different types of protein:

- Insert thermometer in the protein with the lower desired level of doneness.
- Use the Manual feature to choose the desired internal temperature.
- When that protein is done cooking, remove it from the unit.
- Using oven mitts, transfer thermometer to the other protein and use the Manual feature to choose the desired internal temperature.

## HOW TO CORRECTLY INSERT THE THERMOMETER

FOOD TYPE:	PLACEMENT	CORRECT	INCORRECT
<b>Steaks</b> <b>Pork chops</b> <b>Lamb chops</b> <b>Chicken breasts</b> <b>Burgers</b> <b>Tenderloins</b> <b>Fish fillets</b>	<ul style="list-style-type: none"> <li>• Insert thermometer horizontally into the center of the thickest part of the meat.</li> <li>• Make sure the thermometer is close to (but not touching) the bone and away from any fat or gristle.</li> <li>• Make sure the tip of the thermometer is inserted straight into the center of the meat, not angled toward the bottom or top of it.</li> </ul> <p><b>NOTE:</b> The thickest part of the fillet may not be the center. It is important that the end of the thermometer hits this area so that desired results are achieved.</p>		
<b>Whole chicken</b>	<ul style="list-style-type: none"> <li>• Insert thermometer horizontally into the thickest part of the breast, parallel to, but not touching, the bone.</li> <li>• Make sure the tip reaches the center of the thickest part of the breast and doesn't go all the way through the breast into the cavity.</li> </ul>		

**NOTE: DO NOT** use the thermometer with frozen protein or for cuts of meat 1 inch thick or thinner.



# USING THE NINJA® FOODI® SMART GRILL - CONT.

## COOKING FUNCTIONS

Plug in the unit and press the power  button to turn it on.

### Grill

- Place the cooking pot in the unit with the indent on the pot aligned with the bump on the main unit. Then place the grill grate in the pot with the handles facing up. Ensure the splatter shield is in place, then close the hood.

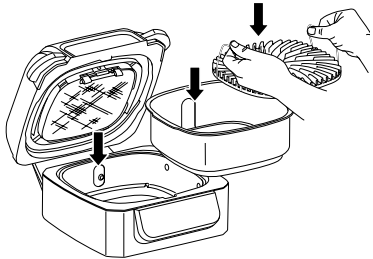

**NOTE:** If you are using the thermometer, refer to the Using the Foodi® Smart Thermometer section.

- Press the GRILL button. The default temperature setting will display. Use the set of arrows to the left of the display to adjust the temperature up to MAX.



- Use the set of arrows to the right of the display to adjust the cook time, in 1-minute increments, up to 30 minutes, or, if using the thermometer, refer to the instructions on previous pages.



- Press START/STOP to begin preheating. The progress bar will begin illuminating. It will take approximately 10 minutes for the unit to preheat.

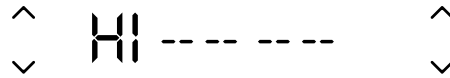

- When preheating is complete, the unit will beep and "ADD FOOD" will appear on the display.



- Open the hood and place ingredients on the grill grate. Once the hood is closed, cooking will begin and the timer will start counting down.

**NOTE:** If you would like to use the thermometer just to check your food's internal doneness, press the thermometer button  for 2 seconds and the food's internal temperature will appear on the screen. Press and hold button again to exit mode.

- When cook time is complete, the unit will beep and END will appear on the display.



**NOTE:** If batch cooking, refer to page 8 for instructions.

## Air Crisp

- Place cooking pot in the unit with the indent on the pot aligned with the bump on the main unit. Place the crisper basket in the pot. Ensure the splatter shield is in place, then close the hood.

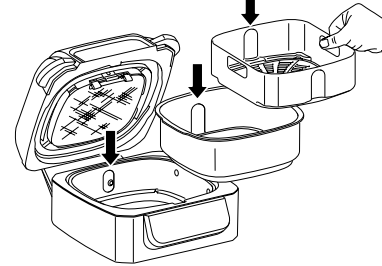

- Press the AIR CRISP button. The default temperature setting will display. Use the set of arrows to the left of the display to adjust the temperature up to 400°F.



- Use the set of arrows to the right of the display to adjust the cook time, in 1-minute increments, up to 1 hour, or, if using the thermometer, refer to Using the Foodi® Smart Thermometer section.



- Press START/STOP to begin preheating. The progress bar will begin illuminating. It will take approximately 3 minutes for the unit to preheat.

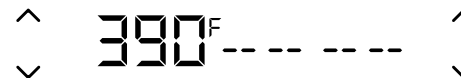

**NOTE:** While preheating is strongly recommended for best results, you can skip it by pressing the PREHEAT button. "ADD FOOD" will appear on the display. Open the hood and place ingredients in the crisper basket. Once the hood is closed, cooking will begin and the timer will start counting down.

- When preheating is complete, the unit will beep and "ADD FOOD" will appear on the display.



- Open the hood and place ingredients in the crisper basket. Once the hood is closed, cooking will begin and the timer will start counting down.

**NOTE:** If you would like to use the thermometer just to check your food's internal doneness, press thermometer button  for 2 seconds and the food's internal temperature will appear on the screen. Press and hold button again to exit mode.

- For best results, we recommend shaking ingredients frequently. When you open the hood, the unit will pause. Use silicone-tipped tongs or oven mitts to shake the basket. When done, replace the basket and close the hood. Cooking will automatically resume after hood is closed.

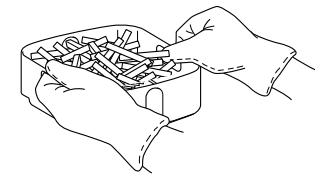

- When cook time is complete, the unit will beep and END will appear on the display.



## USING THE NINJA® FOODI® SMART GRILL - CONT.

### Roast

- 1 Place cooking pot in the unit with the indent on the pot aligned with the bump on the main unit. Ensure the splatter shield is in place, then close the hood.

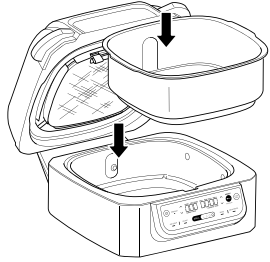

- 2 Press the ROAST button. The default temperature setting will display. Use the set of arrows to the left of the display to adjust the temperature up to 425°F.



**NOTE:** Convert traditional oven recipes by reducing the temperature by 25°F. Check food frequently to avoid overcooking.

- 3 Use the set of arrows to the right of the display to adjust the cook time, in 1-minute increments up to 1 hour and 5-minute increments from 1 to 4 hours, or, if using the thermometer, refer to the Using the Foodi® Smart Thermometer section.



- 4 Press START/STOP to begin preheating. The progress bar will begin illuminating. It will take approximately 3 minutes for the unit to preheat.

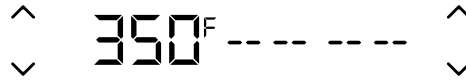

**NOTE:** While preheating is strongly recommended for best results, you can skip it by pressing the PREHEAT button. "ADD FOOD" will appear on the display. Open the hood and place ingredients in the cooking pot. Once the hood is closed, cooking will begin and the timer will start counting down.

- 5 When preheating is complete, the unit will beep and "ADD FOOD" will appear on the display.



- 6 Open the hood and place ingredients in the pot. Once the hood is closed, cooking will begin and the timer will start counting down.

**NOTE:** If you would like to use the thermometer just to check your food's internal doneness, press thermometer button  for 2 seconds and the food's internal temperature will appear on the screen. Press and hold button again to exit mode.

- 7 When cook time is complete, the unit will beep and END will appear on the display.



### Bake

- 1 Place cooking pot in the unit with the indent on the pot aligned with the bump on the main unit. Ensure the splatter shield is in place, then close the hood.

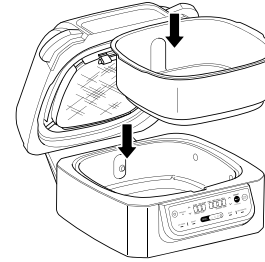

- 2 Press the BAKE button. The default temperature setting will display. Use the set of arrows to the left of the display to adjust the temperature up to 400°F.



**NOTE:** Convert traditional oven recipes by reducing the temperature by 25°F. Check food frequently to avoid overcooking.

- 3 Use the set of arrows to the right of the display to adjust the cook time, in 1-minute increments, up to 1 hour and in 5-minute increments from 1 to 2 hours, or, if using the thermometer, refer to Using the Foodi® Smart Thermometer section.



- 4 Press START/STOP to begin preheating. The progress bar will begin illuminating. It will take approximately 3 minutes for the unit to preheat.

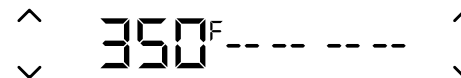

**NOTE:** While preheating is strongly recommended for best results, you can skip it by pressing the PREHEAT button. "ADD FOOD" will appear on the display. Open the hood and place ingredients in the crisper basket. Once the hood is closed, cooking will begin and the timer will start counting down.

- 5 When preheating is complete, the unit will beep and "ADD FOOD" will appear on the display.



- 6 Open the hood and add ingredients to the pot or set the bake pan directly in the pot, and close the hood to start cooking. Once the hood is closed, cooking will begin and the timer will start counting down.



**NOTE:** If you would like to use the thermometer just to check your food's internal doneness, press thermometer button  for 2 seconds and the food's internal temperature will appear on the screen. Press and hold button again to exit mode.

- 7 When cook time is complete, the unit will beep and END will appear on the display.





## USING THE NINJA® FOODI® SMART GRILL - CONT.

### Dehydrate

- 1 Place cooking pot in the unit with the indent on the pot aligned with the bump on the main unit. Place a single layer of ingredients in the pot. Then place the crisper basket in the pot on top of the ingredients and add another layer of ingredients to the basket. Ensure the splatter shield is in place, then close the hood.

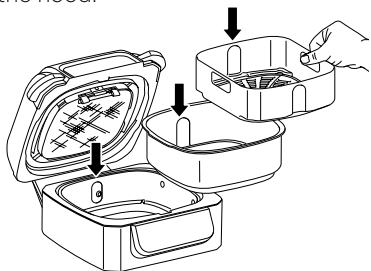

- 2 Press the DEHYDRATE button. The default temperature setting will display. Use the set of arrows to the left of the display to adjust the temperature up to 195°F.



- 3 Use the set of arrows to the right of the display to adjust the dehydration time, in 15-minute increments, up to 12 hours.



- 4 Press START/STOP to begin. (The unit does not preheat in Dehydrate mode.)
- 5 When dehydration time is complete, the unit will beep and END will appear on the display.



## CLEANING YOUR NINJA® FOODI® SMART GRILL

The unit should be cleaned thoroughly after every use. Always let the appliance cool before cleaning.

- Unplug the unit from the wall outlet before cleaning. Keep the hood open after removing your food to allow the unit to cool quicker.
- The cooking pot, grill grate, crisper basket, splatter shield, cleaning brush, and any other included accessories are dishwasher safe, except the thermometer. **DO NOT place the thermometer in the dishwasher.**
- If hand-washing, we recommend using the included cleaning brush to help wash the parts. Use the opposite end of the cleaning brush as a scraper to assist with releasing baked-on sauces or cheese. Air-dry or towel-dry all parts after hand-washing.

**NOTE: DO NOT** use liquid cleaning solution on or near the thermometer jack. We recommend using compressed air or a cotton swab to avoid damaging the jack.

**STORAGE TIP:** When stacking the coated accessories to store place a cloth or paper towel between each piece to protect the coated surfaces.

- If food residue or grease are stuck on the grill grate, splatter shield, or any other removable part, soak in warm soapy water before cleaning.
- Clean the splatter shield after every use. Soaking the splatter shield overnight will help soften the baked-on grease. After soaking, use the cleaning brush to remove the grease from the stainless steel frame and front tabs.
- Deep clean the splatter shield by putting it in a pot of water and boiling it for 10 minutes. Then, rinse with room temperature water and allow to dry completely.
- The Foodi Smart Thermometer and holder are handwash with a damp cloth only. Never place unit or thermometer in dishwasher or submerge in liquid of any kind.

**NOTE: NEVER** use abrasive tools or cleaners. **NEVER** immerse the main unit in water or any other liquid.

## REPLACEMENT PARTS

To order additional parts and accessories, visit [ninjaaccessories.com](http://ninjaaccessories.com) or contact Customer Service at 1-877-646-5288. So we may better assist you, please register your product online at [registryourninja.com](http://registryourninja.com) and have the product on hand when you call.

## TROUBLESHOOTING

- **“Add Food” appears on the control panel display.**  
The unit has completed preheating and it is now time to add your ingredients.
- **“Shut Lid” appears on the control panel display.**  
The hood is open and needs to be closed for the selected function to start.
- **“Plug In” appears on the control panel display.**  
The thermometer is not plugged into the jack on the right side of the control panel. Plug the thermometer in before proceeding. Press the thermometer in until you hear a click.
- **“PRBE ERR” appears on the control panel display.**  
This means the unit timed out before food reached the set internal temperature. As a protection for the unit, it can run for only certain lengths of time at specific temperatures.
- **“E” appears on the control panel display.**  
The unit is not functioning properly. Contact Customer Service at 1-877-646-5288. So we may better assist you, please register your product online at [registeryourninja.com](http://registeryourninja.com) and have the product on hand when you call.
- **Why is my food overcooked or undercooked even though I used the thermometer?**  
It is important to insert the thermometer lengthwise into the thickest part of the ingredient to get the most accurate reading. Make sure to allow food to rest for 3–5 minutes to complete cooking. For more information, refer to the Using the Foodi® Smart Thermometer section.
- **Why does the preheat progress bar not start from the beginning?**  
When the unit is warm from previously being used, it will not require the full preheating time.
- **Can I cancel or override preheating?**  
Preheating is highly recommended for best results, but you can skip it by selecting the PREHEAT button after you press the START/STOP button.
- **Should I add my ingredients before or after preheating?**  
For best results, let the unit preheat before adding ingredients.
- **Why is my unit emitting smoke?**  
When using the Grill function, always select the recommended temperature setting. Recommended settings can be found in the Quick Start Guide and in the Inspiration Guide. Make sure the splatter shield is installed.
- **How do I pause the unit so I can check my food?**  
When the hood is opened during a cooking function, the unit will automatically pause.
- **Will the thermometer grip melt if it touches the hot grill grate?**  
No, the grip is made of a high-temperature silicone that can handle the Ninja® Foodi® Smart Grill's high temperatures.
- **My food is burned.**  
Do not add food until recommended preheat time is complete. For best results, check progress throughout cooking, and remove food when desired level of brownness has been achieved. Remove food immediately after the cook time is complete to avoid overcooking.
- **Why did a circuit breaker trip while using the unit?**  
The unit uses 1760 watts of power, so it must be plugged into an outlet on a 15-amp circuit breaker. Using an outlet on a 10-amp breaker will cause the breaker to trip. It is also important that the unit be the only appliance plugged into an outlet when in use. To avoid tripping a breaker, make sure the unit is the only appliance plugged into an outlet on a 15-amp breaker.
- **Why does the unit have a 1–9 scale for the Beef Preset?**  
Perception of what a specific internal doneness looks like differs from person to person, even restaurant to restaurant. The 1–9 scale provides a wide range of options for each doneness level so you can customize doneness to your liking.

# Shark NINJA

## ONE (1) YEAR LIMITED WARRANTY

The One (1) Year Limited Warranty applies to purchases made from authorized retailers of **SharkNinja Operating LLC**. Warranty coverage applies to the original owner and to the original product only and is not transferable.

SharkNinja warrants that the unit shall be free from defects in material and workmanship for a period of one (1) year from the date of purchase when it is used under normal household conditions and maintained according to the requirements outlined in the Owner's Guide, subject to the following conditions and exclusions:

### What is covered by this warranty?

1. The original unit and/or non-wearable parts deemed defective, in SharkNinja's sole discretion, will be repaired or replaced up to one (1) year from the original purchase date.
2. In the event a replacement unit is issued, the warranty coverage ends six (6) months following the receipt date of the replacement unit or the remainder of the existing warranty, whichever is later. SharkNinja reserves the right to replace the unit with one of equal or greater value.

### What is not covered by this warranty?

1. Normal wear and tear of wearable parts (such as blending vessels, lids, cups, blades, blender bases, removable pots, racks, pans, etc.), which require regular maintenance and/or replacement to ensure the proper functioning of your unit, are not covered by this warranty. Replacement parts are available for purchase at [ninjaccessories.com](http://ninjaccessories.com).
2. Any unit that has been tampered with or used for commercial purposes.
3. Damage caused by misuse, abuse, negligent handling, failure to perform required maintenance (e.g., failure to keep the well of the motor base clear of food spills and other debris), or damage due to mishandling in transit.
4. Consequential and incidental damages.
5. Defects caused by repair persons not authorized by SharkNinja. These defects include damages caused in the process of shipping, altering, or repairing the SharkNinja product (or any of its parts) when the repair is performed by a repair person not authorized by SharkNinja.
6. Products purchased, used, or operated outside North America.

### How to get service

If your appliance fails to operate properly while in use under normal household conditions within the warranty period, visit [ninjakitchen.com/support](http://ninjakitchen.com/support) for product care and maintenance self-help. Our Customer Service Specialists are also available at **1-877-646-5288** to assist with product support and warranty service options, including the possibility of upgrading to our VIP warranty service options for select product categories. So we may better assist you, please register your product online at [registeryourninja.com](http://registeryourninja.com) and have the product on hand when you call.

SharkNinja will cover the cost for the customer to send in the unit to us for repair or replacement. A fee of \$20.95 (subject to change) will be charged when SharkNinja ships the repaired or replacement unit.

### How to initiate a warranty claim

You must call **1-877-646-5288** to initiate a warranty claim. You will need the receipt as proof of purchase. We also ask that you register your product online at [registeryourninja.com](http://registeryourninja.com) and have the product on hand when you call, so we may better assist you. A Customer Service Specialist will provide you with return and packing instruction information.

### How state law applies

This warranty gives you specific legal rights, and you also may have other rights that vary from state to state. Some states do not permit the exclusion or limitation of incidental or consequential damages, so the above may not apply to you.

**SharkNinja Operating LLC**  
**US: Needham, MA 02494**  
**1-877-646-5288**  
**ninjakitchen.com**

Illustrations may differ from actual product. We are constantly striving to improve our products, therefore the specifications contained herein are subject to change without notice.

FOODI and NINJA are registered trademarks of SharkNinja Operating LLC.

This product may be covered by one or more U.S. patents. See [sharkninja.com/patents](http://sharkninja.com/patents) for more information.

© 2021 SharkNinja Operating LLC

PRINTED IN CHINA

LG450Series\_IB\_MP\_Mv3



**@ninjakitchen**