

NINJA®

SP100
Series

OWNER'S GUIDE

**FOODI® DIGITAL
AIR FRY OVEN**



THANK YOU

for purchasing the Ninja® Foodi® Digital Air Fry Oven



REGISTER YOUR PURCHASE

 registeryourninja.com

 Scan QR code using mobile device

RECORD THIS INFORMATION

Model Number: _____

Serial Number: _____

Date of Purchase: _____
(Keep receipt)

Store of Purchase: _____

TECHNICAL SPECIFICATIONS

Voltage: 120V~ 60Hz

Watts: 1800W

TIP: You can find the model and serial numbers on the QR code label located on the base of the unit.

CONTENTS

Important Safeguards	2
Parts	4
Accessory Placement	5
Before First Use	5
Using the Control Panel	6
Functions	7
Control Panel Display & Operating Buttons	7
Power Cord Management	8
Using Your Foodi® Digital Air Fry Oven	9
Using the Cooking Functions	9
Air Fry	9
Air Roast	10
Air Broil	10
Bake	11
Toast	11
Bagel	12
Dehydrate	12
Keep Warm	12
Cleaning, Maintenance & Storage	13
Everyday Cleaning	13
Deep Cleaning	13
Flip-Up-And-Away Storage	14
Accessories for Purchase	15
Troubleshooting & FAQ	16
Replacement Parts	16
Warranty	17

IMPORTANT SAFEGUARDS

HOUSEHOLD USE ONLY • READ ALL INSTRUCTIONS BEFORE USE

When using electrical appliances, basic safety precautions should always be followed, including the following:

⚠ WARNING

- 1 Read all instructions prior to using the oven and its accessories.
- 2 This appliance can be used by persons with reduced physical, sensory or mental capabilities or lack of experience and knowledge if they have been given supervision or instruction concerning use of the appliance in a safe way and understand the hazards involved.
- 3 To eliminate a choking hazard for young children, remove and discard the protective cover fitted on the power plug of this oven.
- 4 Take inventory of all contents to ensure you have all parts needed to properly and safely operate your oven.
- 5 **DO NOT** use an extension cord. A short power-supply cord is used to reduce the risk of children grabbing the cord or becoming entangled and to reduce the risk of people tripping over a longer cord.
- 6 **NEVER** use outlet below counter.
- 7 Keep the appliance and its cord out of reach of children. Do not allow the appliance to be used by children. Close supervision is necessary when used near children.
- 8 **DO NOT** let cord hang over edges of tables or counters or touch hot surfaces, including stoves and other heating ovens.
- 9 **NEVER** leave the oven unattended while in use.
- 10 **DO NOT** cover crumb tray or any part of the oven with metal foil. This will cause the oven to overheat or cause a fire.
- 11 **NEVER** place aluminum foil on top of the sheet pan or broil rack. This traps grease and can cause a fire.
- 12 To protect against electrical shock **DO NOT** immerse cord, plugs, or main unit housing in water or other liquid.
- 13 **DO NOT** use the oven with damage to the power cord or plug. Regularly inspect the oven and power cord. If the oven malfunctions or has been damaged in any way, immediately stop use and call Customer Service.
- 14 **DO NOT** cover the air intake vents or air outlet vents while unit is operating. Doing so will prevent even cooking and may damage the unit or cause it to overheat.
- 15 **DO NOT** insert anything in the ventilation slots and do not obstruct them.
- 16 **DO NOT** place items on top of surface while unit is operating except for authorized recommended Ninja accessories.
- 17 Before placing any accessories into the oven ensure they are clean and dry.
- 18 Intended for countertop use only. **DO NOT** place the oven near the edge of a countertop. Ensure the surface is level, clean and dry.
- 19 This oven is for household use only. **DO NOT** use this oven for anything other than its intended use. Misuse may cause injury.
- 20 **DO NOT** store any materials, other than supplied accessories, in this oven when not in use.
- 21 **DO NOT** use outdoors. **DO NOT** use in moving vehicles or boats.
- 22 **DO NOT** use accessory and attachments not recommended or sold by SharkNinja.
- 23 When using this oven, provide adequate space above and on all sides for air circulation.
- 24 A fire may occur if the oven is covered or touching flammable material, including curtains, draperies, walls, or the like when in operation. **DO NOT** place anything on the oven during operation.

- 25 This oven has a tempered glass door and is more resistant to breakage. Avoid scratching door surface or nicking edges.
- 26 **DO NOT** use the oven without the wire rack installed, except when using Air Fry Basket.
- 27 **DO NOT** spray any type of aerosol spray or flavoring inside the oven while cooking.
- 28 Use caution when inserting and removing anything from the oven, especially when hot.
- 29 Outlet voltages can vary, affecting the performance of your product. To prevent possible illness, use a thermometer to check that your food is cooked to the temperatures recommended.
- 30 Prevent food contact with heating elements. Excessive food loads may cause personal injury or property damage or affect the safe use of the oven.
- 31 **DO NOT** place any of the following materials in the oven: paper, cardboard, plastic, roasting bags and the like.
- 32 Extreme caution should be exercised when using containers constructed of any materials other than metal or glass.
- 33 **DO NOT** touch hot surfaces. Oven surfaces are hot during and after operation. To prevent burns or personal injury, **ALWAYS** use protective hot pads or insulated oven mitts and use available handles and knobs.
- 34 Spilled food can cause serious burns. Extreme caution must be used when the oven contains hot food. Improper use may result in personal injury.
- 35 Please refer to the Cleaning & Maintenance section for regular maintenance of the oven.
- 36 Cleaning and user maintenance shall not be made by children.
- 37 Press the power button to turn oven off and allow to cool completely before cleaning, moving and flipping for storage.
- 38 Unplug from outlet when not in use. To unplug, grasp the plug by the body and pull from the outlet. Never unplug by grasping and pulling the flexible cord.
- 39 **DO NOT** clean with metal scouring pads. Pieces can break off the pad and touch electrical parts, causing a risk of electrical shock.
- 40 **DO NOT** use the oven as a source of heat or for drying.



Indicates to read and review instructions to understand operation and use of product.



Indicates the presence of a hazard that can cause personal injury, death or substantial property damage if the warning included with this symbol is ignored.



Take care to avoid contact with hot surface. Always use hand protection to avoid burns.



For indoor and household use only.

SAVE THESE INSTRUCTIONS

PARTS

A Main Unit

(attached power cord not shown)

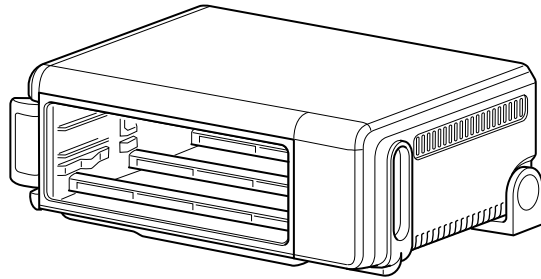

B Removable Crumb Tray

(always place below the bottom heating element)

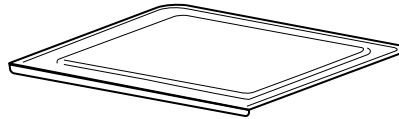

C Wire Rack

(keep in the bottom rail position)

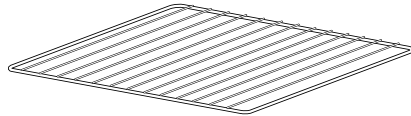

D Sheet Pan

(always layer on top of the wire rack)

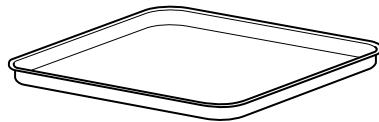

E Air Fry Basket

(use in the top rail position)

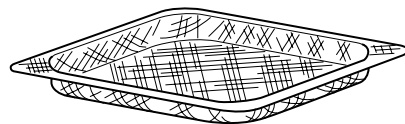

ACCESSORY PLACEMENT

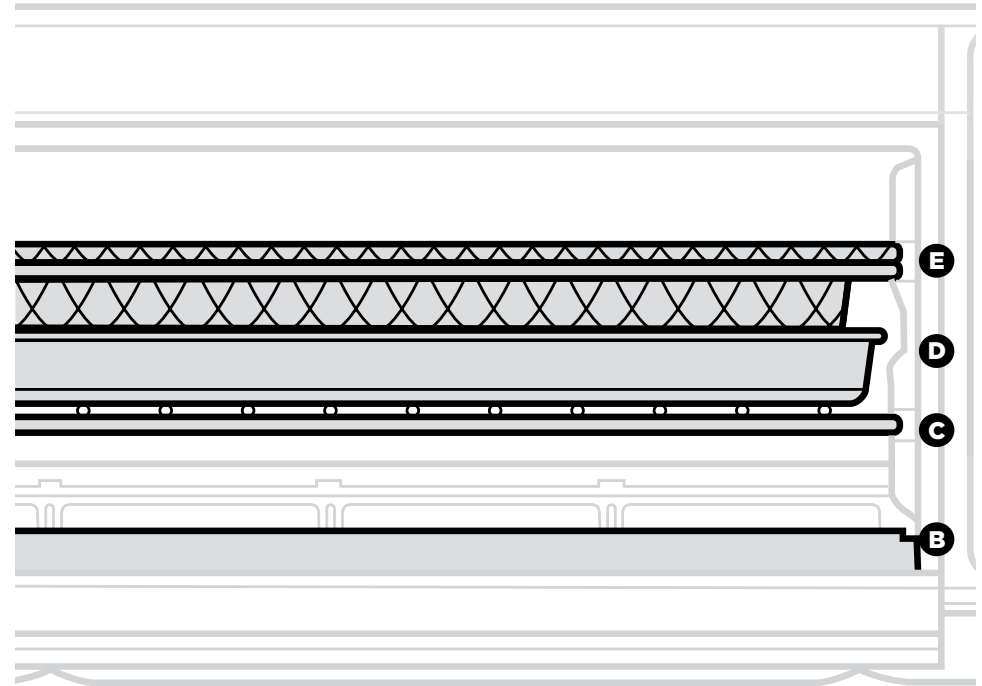

BEFORE FIRST USE

- 1 Remove and discard any packaging material, promotional labels, and tape from the unit.
- 2 Remove all accessories from the package and read this manual carefully. Please pay particular attention to operational instructions, warnings, and important safeguards to avoid any injury or property damage.
- 3 Wash the air fry basket, sheet pan, wire rack, and removable crumb tray in warm, soapy water, then rinse and dry thoroughly. **NEVER** clean the main unit in the dishwasher.
- 4 We recommend placing all accessories inside the oven and running it on Air Fry at 450°F for 20 minutes without adding food. Make sure the area is well ventilated. This removes any packaging residue and odor traces that may be present. This is completely safe and not detrimental to the performance of the oven.

NOTE: For longest use, we recommend hand-washing the accessories.

USING THE CONTROL PANEL

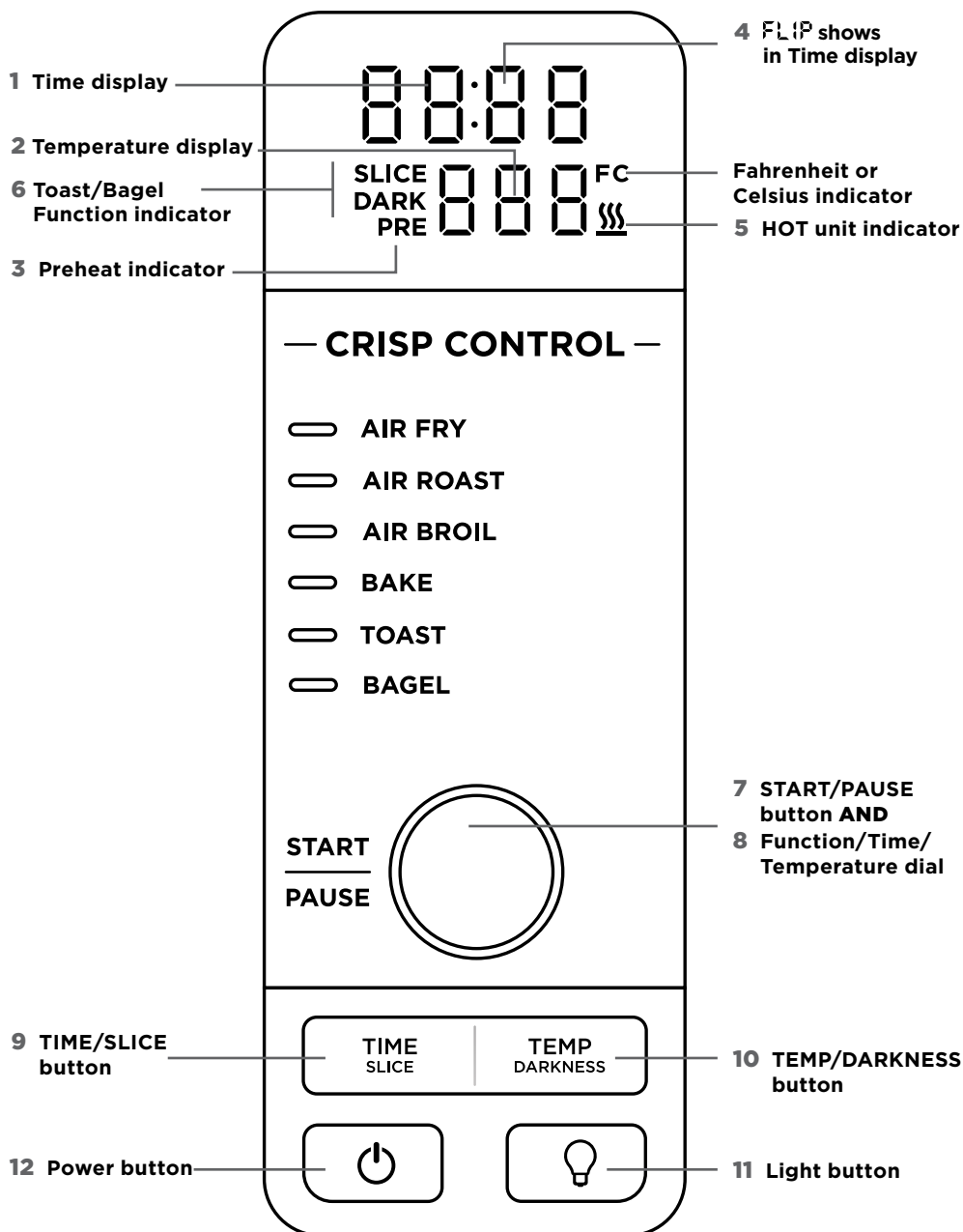

FUNCTIONS

AIR FRY: Make foods that would traditionally be fried—such as chicken wings, French fries, and chicken nuggets—with little to no added oil.

AIR ROAST: Achieve a crispy outside and perfectly cooked inside for full-sized sheet pan meals, thicker proteins, and roasted veggies.

AIR BROIL: Broils meat and fish and evenly browns the tops of casseroles.

BAKE: Evenly bakes everything from your favorite cookies to homemade pizzas.

TOAST: Evenly toasts up to 9 slices of bread to your perfect level of darkness.

BAGEL: Perfectly toast up to 6 slices of bagels halves when they're placed cut-side up on the wire rack.

DEHYDRATE: Dehydrates meats, fruits, and vegetables for healthy snacks.

KEEP WARM: Keeps food warm up to 2 hours.

NOTE: The Dehydrate and Keep Warm functions are not included on all models.

CONTROL PANEL DISPLAY & OPERATING BUTTONS

1 Time display: Shows the cook time. The time will count down when cooking is in progress.

2 Temperature display: Shows the cook temperature.

NOTE: Time and temperature will always return to the cook time and temperature that was set the last time the oven was in use.

3 PRE flashes when the unit is preheating.

4 FLIP will appear on the time display when the unit is cool enough to flip up for storage or cleaning.

5 HOT illuminates when the unit is hot and will turn off when the oven is cool enough to be flipped up for storage or cleaning.

6 SLICE and **DARK** will illuminate when using the Toast or Bagel function.

7 START/PAUSE button: Press to start or pause cooking.

8 Function/Time/Temperature dial: Turn to select a cooking function or adjust time and temperature (or number of slices and darkness level when using the Toast and Bagel functions).

NOTE: Press and hold the START/PAUSE button for 3 seconds to return to the function selection.

9 TIME/SLICE button: To select a cook time, press the TIME button, then use the dial to adjust the time. When using the Toast or Bagel function, this button will adjust the number of slices instead of the time.

10 TEMP/DARKNESS button: To adjust temperature, press the TEMP button and use the dial to adjust the temperature. When using the Toast or Bagel function, this button will adjust the darkness level instead of the temperature.

NOTE: The cook time and temperature may be adjusted at any time during the cooking cycle.

NOTE: To switch from Fahrenheit to Celsius, press and hold the TEMP/DARKNESS button for 3 seconds while the unit is not in cook mode.

11 Light button: Press to turn the oven's interior light on and off.

NOTE: The light will automatically turn on when there are 30 seconds of cook time remaining.

12 Power button: Press to turn the unit on and off.

POWER CORD MANAGEMENT

Our cord-management system is designed so it will not interfere with the oven's flip-away functionality.

Option 1 Outlet on the left

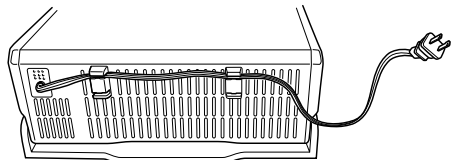

Option 2 Outlet on the right

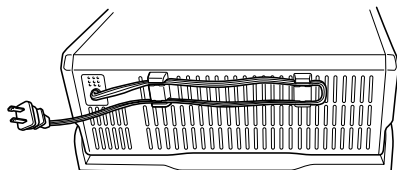

Option 3 Outlet behind the oven

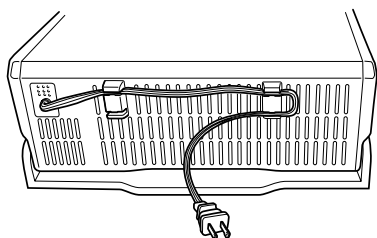

USING YOUR FOODI® DIGITAL AIR FRY OVEN

USING THE COOKING FUNCTIONS

To turn on the unit, plug the power cord into the wall, flip oven down into cooking position, and press the  button.

NOTE: The unit preheats quickly, so we recommend prepping all ingredients before turning on the oven.

Air Fry

- 1 To select the function, turn the dial until AIR FRY illuminates. The default time and temperature settings will display.
- 2 Press the TIME/SLICE button and use the dial to select your time up to 1 hour. To set the time, press the TIME/SLICE button again.
- 3 Then press the TEMP/DARKNESS button and use the dial to select a temperature between 250°F-450°F. To set the temperature, press the TEMP/DARKNESS button again.
- 4 Press START/PAUSE to begin preheating.
- 5 Place ingredients in the air fry basket. If ingredients are fatty, oily, or marinated, place the basket on the sheet pan.



Use air fry basket for dry ingredients.

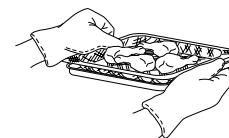

Use air fry basket with sheet pan underneath for fatty, oily, or marinated ingredients.

- 6 When the unit beeps to signify it has preheated, immediately slide the basket into the upper rails of the oven. If also using the sheet pan, slide both into the oven at the same time, with the basket in the upper rails and the pan on the wire rack beneath the basket. Close oven door.

NOTE: The timer will start counting down as soon as the unit has preheated. If ingredients are not ready to go into the oven, simply turn the dial to add more time.

- 7 For more even browning and crispiness, toss ingredients or turn the basket 180° halfway through cooking cycle.

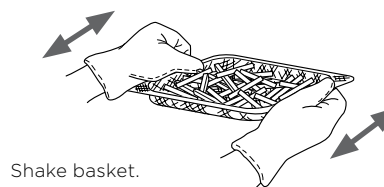

Shake basket.

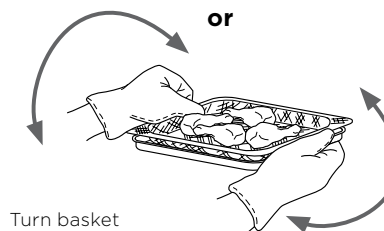

Turn basket and sheet pan 180°.

- 8 When cook time is complete, the unit will beep.

USING YOUR FOODI® DIGITAL AIR FRY OVEN – CONT.

Air Roast

- 1 To select the function, turn the dial until AIR ROAST illuminates. The default time and temperature settings will display.
- 2 Press the TIME/SLICE button and use the dial to select your time up to 2 hours. To set the time, press TIME/SLICE button again.

NOTE: If cooking for 1 hour or less, the clock will count down by minutes and seconds. If cooking for more than 1 hour, the clock will count down by hours and minutes.

- 3 Press the TEMP/DARKNESS button and use the dial to select a temperature between 250°F–450°F. To set the temperature, press the TEMP/DARKNESS button again.
- 4 Press START/PAUSE to begin preheating.

NOTE: Food cooks faster when using the Air Roast function than when using the Bake function, so for traditional oven recipes, lower the cook time 30% and lower the temperature 25°F.

- 5 Place ingredients on the sheet pan. When the unit beeps to signify it has preheated, immediately place the sheet pan on the wire rack. Close oven door.

NOTE: The timer will start counting down as soon as the unit has preheated. If ingredients are not ready to go into the oven, simply turn the dial to add more time.

- 6 During cooking, you can open the oven door to check on or flip ingredients.

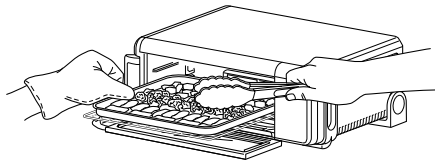

- 7 When cook time is complete, the unit will beep.

Air Broil

- 1 To select the function, turn the dial until AIR BROIL illuminates. The default time and temperature settings will display.
- 2 Press the TIME/SLICE button and use the dial to select your time up to 30 minutes. To set the time, press the TIME/SLICE button again.
- 3 Press the TEMP/DARKNESS button and use the dial to select either HI or LO. To set the temperature, press the TEMP/DARKNESS button again.
- 4 Place ingredients on the sheet pan. Place the sheet pan on the wire rack and close the oven door, press START/STOP to start cooking.

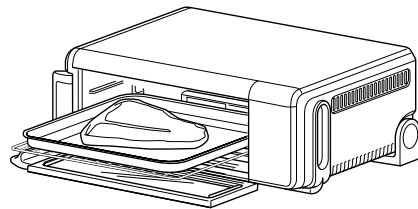

- 6 During cooking, you can open the oven door to check on or flip ingredients.

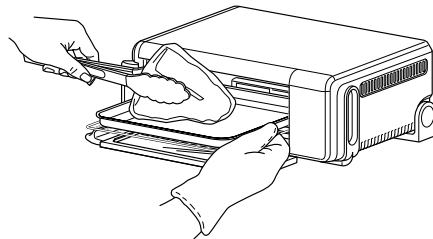

- 7 When cook time is complete, the unit will beep.

Bake

- 1 To select the function, turn the dial until BAKE illuminates. The default time and temperature settings will display.
- 2 Press the TIME/SLICE button and use the dial to select your time up to 2 hours. To set the time, press the TIME/SLICE button again.

NOTE: If cooking for 1 hour or less, the clock will count down by minutes and seconds. If cooking for more than 1 hour, the clock will count down by hours and minutes.

- 3 Press the TEMP/DARKNESS button and use the dial to select a temperature between 250°F–450°F. To set the temperature, press the TEMP/DARKNESS button again.
- 4 Press START/PAUSE to begin preheating.
- 5 Place ingredients on the sheet pan. When the unit beeps to signify it has preheated, immediately place the sheet pan on the wire rack. Close oven door.

NOTE: The timer will start counting down as soon as the unit has preheated. If ingredients are not ready to go into the oven, simply turn the dial to add more time.

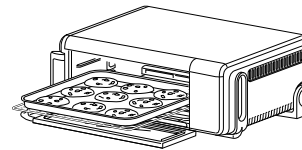

- 6 During cooking, you can open the oven door to check on or flip ingredients.

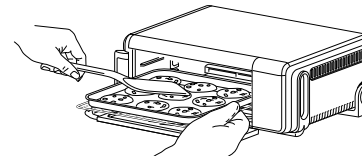

- 7 When cook time is complete, the unit will beep.

NOTE: For best results with baked goods such as cookies, line the Ninja® Sheet Pan with parchment paper.

Toast

- 1 To select the function, turn the dial until TOAST illuminates. The default amount of slices and darkness will be displayed.
- 2 Press the TIME/SLICE button and use the dial to select the number of bread slices. You may toast up to 9 slices at once. To set the number of slices, press the TIME/SLICE button again.
- 3 Press the TEMP/DARKNESS button and use the dial to select a darkness level. To set the darkness level, press the TEMP/DARKNESS button again.

NOTE: There is no temperature adjustment available for the Toast function, and the unit does not preheat in Toast mode. It is very important to select the exact number of slices to avoid over- or under-toasting.

- 4 Place bread slices on the wire rack. Close oven door and press START/PAUSE to begin cooking.

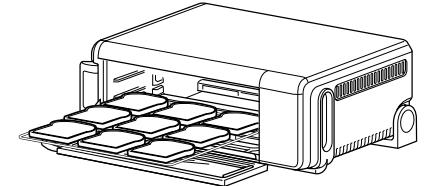

- 5 You do not need to flip the slices during cooking. When cook time is complete, the unit will beep.

USING YOUR FOODI® DIGITAL AIR FRY OVEN – CONT.

Bagel

- 1 To select the function, turn the dial until BAGEL illuminates. The default number of slices and darkness level will display.
- 2 Press the TIME/SLICE button and use the dial to select the number of slices. You may toast up to 6 bagel slices at once. To set the number of slices, press the TIME/SLICE button again.
- 3 Press the TEMP/DARKNESS button and use the dial to select a darkness level. To set the darkness level, press the TEMP/DARKNESS button again.

NOTE: There is no temperature adjustment available for the Bagel function, and the unit does not preheat in Bagel mode. It is very important to select the exact number of slices to avoid over- or under-toasting.

- 4 Place bagel slices, cut-side up, on the wire rack. Close oven door and press START/PAUSE to begin cooking.

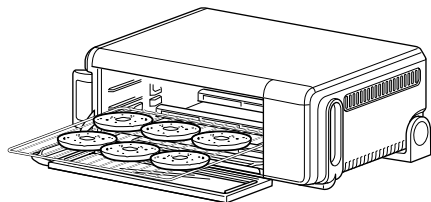

- 5 You do not need to flip the slices during cooking. When cook time is complete, the unit will beep.

Dehydrate

NOTE: The DEHYDRATE function is not included on all models.

- 1 To select the function, turn the dial until DEHYDRATE illuminates. The default time and temperature settings will display.
- 2 Press the TIME/SLICE button and use the dial to select a time up to 12 hours. To set the time, press the TIME/SLICE button again.

- 3 Press the TEMP/DARKNESS button and use the dial to select a temperature between 105°F–195°F. To set the temperature, press the TEMP/DARKNESS button again.
- 4 Place ingredients in the air fry basket and place basket in oven. Close oven door and press START/PAUSE to begin cooking.



- 5 During cooking, you can open the oven door to check on or flip ingredients.
- 6 When cook time is complete, the unit will beep.

Keep Warm

NOTE: The Keep Warm function is not included on all models.

- 1 To select the function, turn the dial until KEEP WARM illuminates. The default time setting will display.
- 2 Press the TIME/SLICE button and use the dial to select a time up to 2 hours. To set the time, press the TIME/SLICE button again.

NOTE: There is no temperature selection available for the Keep Warm function.

- 3 Place food on the sheet pan or in an oven-safe container and place the pan or container on the wire rack. Close oven door and press START/PAUSE to begin warming.

NOTE: The unit does not preheat in Keep Warm mode.

- 4 When warming time is complete, the unit will beep.

CLEANING, MAINTENANCE & STORAGE

EVERYDAY CLEANING

The unit should be cleaned thoroughly after every use.

- 1 Unplug the unit from the outlet and allow it to cool down before cleaning.
- 2 Empty crumb tray by sliding it out of the oven when the oven is in the flipped-down position.

NOTE: Empty crumb tray frequently. Hand-wash when necessary.

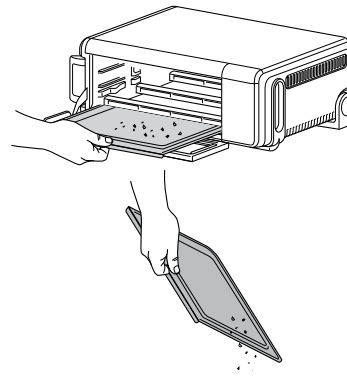
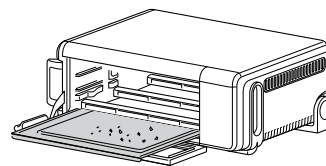

- 3 To clean any food splatter on the interior walls of the unit, wipe them with a soft, damp sponge.
- 4 To clean the exterior of the main unit and the control panel, wipe them clean with a damp cloth. A non-abrasive liquid cleanser or mild spray solution may be used. Apply the cleanser to the sponge, not the oven surface, before cleaning.

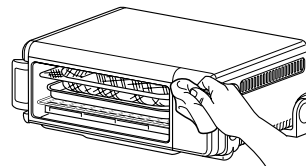

DEEP CLEANING

- 1 Unplug the unit from the outlet and allow it to cool down before cleaning.
- 2 Remove all accessories from the unit, including the crumb tray, and wash separately. Use a non-abrasive cleaning brush to more thoroughly wash the air fry basket.
- 3 Flip up the oven into the storage position.

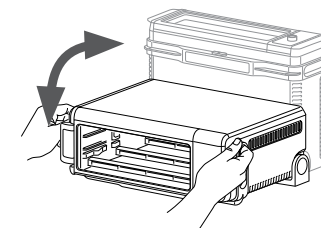

- 4 Press the push button to release the back door to access the oven's interior.

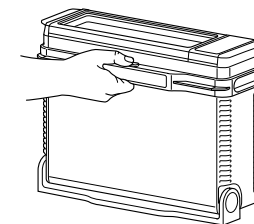

- 5 Use warm, soapy water and a soft cloth to wash the oven's interior. **DO NOT** use abrasive cleaners, scrubbing brushes, or chemical cleaners, as they will damage the oven.

CAUTION: NEVER put the main unit in the dishwasher or immerse it in water or any other liquid.

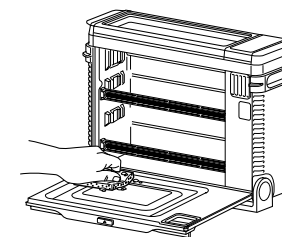

Continued on next page.

CLEANING, MAINTENANCE & STORAGE - CONT.

- 6 To prolong use of accessories, hand-wash with warm, soapy water.
- 7 Thoroughly dry all parts before placing them back in the oven.

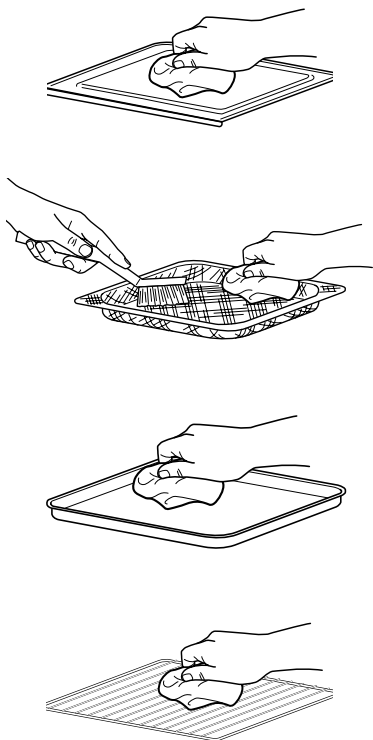

FLIP-UP-AND-AWAY STORAGE

- 1 **DO NOT** flip oven up when  is illuminated. Wait for oven to cool down before handling. Hold handles on each side of the unit.

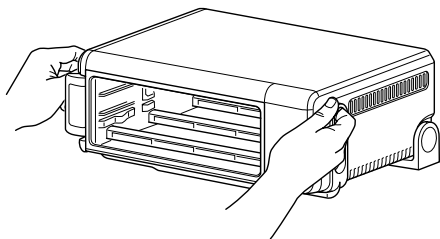

- 2 Lift and flip unit upward.

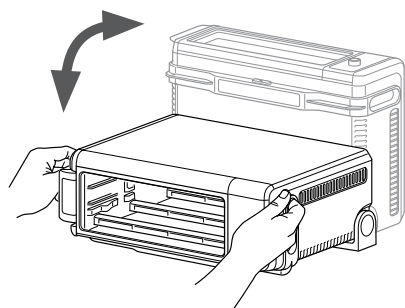

- 3 Leave the unit in the upright position when storing or for deep cleaning.

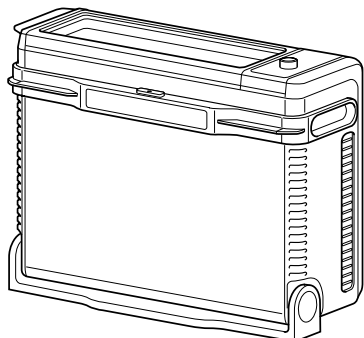

ACCESSORIES FOR PURCHASE

We offer a suite of accessories custom made for your Ninja® Foodi® Digital Air Fry Oven. Visit ninjaaccessories.com to expand your capabilities and take your cooking to the next level.

- Broiling Rack

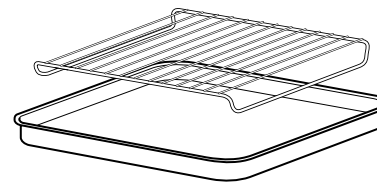

- Casserole Dish/Baking Pan (2" deep)

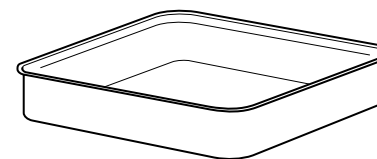

- Egg Bite/Muffin Tray

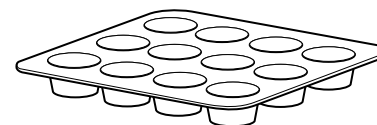

TROUBLESHOOTING & FAQ

ERROR MESSAGES

“CALL CUST SrVC” followed by “Er1” – “Er7”

Power off the unit and call Customer Service at **1-877-646-5288**. So we may better assist you, please register your product online at registeryourninja.com and have the product on hand when you call.

FAQ

Why won't the oven turn on?

- Oven needs to be in flipped-down position in order to power it on.
- Make sure the power cord is securely plugged into the outlet.
- Insert the power cord into a different outlet.
- Reset the circuit breaker if necessary.
- Press the power button.

Can I use the sheet pan instead of the air fry basket with air fry function?

- Yes, but crispiness results may vary.

Do I need to adjust the cook times and temperatures of traditional oven recipes?

- When preparing traditional oven recipes using the Air Roast function, lower cook time by 30% and temperature by 25°F.

Can I restore the unit to its default settings?

- The oven will remember the last setting used for each function, even if you unplug it. To restore the oven's default settings for each function, press the TIME/SLICE and TEMP/DARKNESS buttons simultaneously for 5 seconds.

Why do the heating elements appear to be turning on and off?

- This is normal. The oven is designed to control temperature precisely for every function by adjusting the heating elements' power levels.

Why is steam coming out from the oven door?

- This is normal. The door is vented to release steam created by foods with a high moisture content.

Why is water dripping onto the counter from under the door?

- This is normal. The condensation created by foods with a high moisture content (such as frozen breads) may run down the inside of the door and drip onto the counter.

Why is there noise coming from the control panel?

- When the oven is hot, a fan turns on to cool down the control panel.

REPLACEMENT PARTS

To order additional parts and accessories, visit ninjaaccessories.com or contact Customer Service at **1-877-646-5288**. So we may better assist you, please register your product online at registeryourninja.com and have the product on hand when you call.

Shark NINJA

ONE (1) YEAR LIMITED WARRANTY

The One (1) Year Limited Warranty applies to purchases made from authorized retailers of **SharkNinja Operating LLC**. Warranty coverage applies to the original owner and to the original product only and is not transferable.

SharkNinja warrants that the unit shall be free from defects in material and workmanship for a period of one (1) year from the date of purchase when it is used under normal household conditions and maintained according to the requirements outlined in the Owner's Guide, subject to the following conditions and exclusions:

What is covered by this warranty?

1. The original unit and/or non-wearable parts deemed defective, in SharkNinja's sole discretion, will be repaired or replaced up to one (1) year from the original purchase date.
2. In the event a replacement unit is issued, the warranty coverage ends six (6) months following the receipt date of the replacement unit or the remainder of the existing warranty, whichever is later. SharkNinja reserves the right to replace the unit with one of equal or greater value.

What is not covered by this warranty?

1. Normal wear and tear of wearable parts (such as blending vessels, lids, cups, blades, blender bases, removable pots, racks, pans, etc.), which require regular maintenance and/or replacement to ensure the proper functioning of your unit, are not covered by this warranty. Replacement parts are available for purchase at ninjaaccessories.com.
2. Any unit that has been tampered with or used for commercial purposes.
3. Damage caused by misuse, abuse, negligent handling, failure to perform required maintenance (e.g., failure to keep the well of the motor base clear of food spills and other debris), or damage due to mishandling in transit.
4. Consequential and incidental damages.
5. Defects caused by repair persons not authorized by SharkNinja. These defects include damages caused in the process of shipping, altering, or repairing the SharkNinja product (or any of its parts) when the repair is performed by a repair person not authorized by SharkNinja.
6. Products purchased, used, or operated outside North America.

How to get service

If your appliance fails to operate properly while in use under normal household conditions within the warranty period, visit ninjakitchen.com/support for product care and maintenance self-help. Our Customer Service Specialists are also available at **1-877-646-5288** to assist with product support and warranty service options, including the possibility of upgrading to our VIP warranty service options for select product categories. So we may better assist you, please register your product online at registeryourninja.com and have the product on hand when you call.

SharkNinja will cover the cost for the customer to send in the unit to us for repair or replacement. A fee of \$20.95 (subject to change) will be charged when SharkNinja ships the repaired or replacement unit.

How to initiate a warranty claim

You must call **1-877-646-5288** to initiate a warranty claim. You will need the receipt as proof of purchase. We also ask that you register your product online at registeryourninja.com and have the product on hand when you call, so we may better assist you. A Customer Service Specialist will provide you with return and packing instruction information.

How state law applies

This warranty gives you specific legal rights, and you also may have other rights that vary from state to state. Some states do not permit the exclusion or limitation of incidental or consequential damages, so the above may not apply to you.

SharkNinja Operating LLC
US: Needham, MA 02494
1-877-646-5288
ninjakitchen.com

Illustrations may differ from actual product. We are constantly striving to improve our products, therefore the specifications contained herein are subject to change without notice.

NINJA and FOODI are registered trademarks of SharkNinja Operating LLC.

This product may be covered by one or more U.S. patents.
See sharkninja.com/patents for more information.