

NINJA®

BL680A
OWNER'S GUIDE



ninjakitchen.com
1 877 646-5288

IMPORTANT SAFETY INSTRUCTIONS

For Household Use Only

WHEN USING ELECTRICAL APPLIANCES, BASIC SAFETY PRECAUTIONS SHOULD ALWAYS BE FOLLOWED, INCLUDING THE FOLLOWING:

READ ALL INSTRUCTIONS BEFORE USING YOUR NUTRI NINJA® | NINJA® BLENDER WITH AUTO-iQ™ TECHNOLOGY.

POLARIZED PLUG

⚠ WARNING: To reduce the risk of electric shock, this appliance has a polarized plug (one blade is wider than the other). This plug will fit into a polarized outlet only one way. If the plug does not fit fully into the outlet, reverse the plug. If it still does not fit, contact a qualified electrician to install the proper outlet. **DO NOT** modify the plug in any way.

⚠ WARNING: Extension cords are not recommended for use with this product.

⚠ WARNING:

TO REDUCE THE RISK OF FIRE, ELECTRIC SHOCK OR INJURY:

- 1 **⚠ WARNING:** Remove utensils prior to processing. Failure to remove may cause the jar to be damaged or to shatter which may cause personal injury.
- 2 **⚠ WARNING:** The blade assemblies are sharp, not locked in place and removable, handle with care. When handling the blade assemblies, always hold by the shaft. Failure to do so will result in a risk of laceration.
- 3 **⚠ WARNING:** Stacked Blade Assembly is sharp and not locked in place. If using the pour spout, ensure the lid is fully locked onto the pitcher. If pouring with the lid removed, carefully remove the Stacked Blade Assembly first, holding it by the shaft. Failure to do so will result in a risk of laceration.
- 4 **⚠ WARNING:** Chopping Blade Assembly is sharp and not locked in place. Before emptying contents carefully remove lid and Chopping Blade Assembly, holding it by the shaft. Failure to do so will result in a risk of laceration.
- 5 **⚠ CAUTION:** Do not blend hot liquids, doing so may cause excessive pressure build-up, resulting in risk of the user being burned.
- 6 **⚠ CAUTION:** We do not recommend grinding in any of our Nutri Ninja® Cups.
- 7 **⚠ CAUTION:** Remove the Pro Extractor Blades® Assembly from the Nutri Ninja cup upon completion of blending. Some ingredients have the potential to expand after blending resulting in excessive pressure buildup that can pose a risk of injury.

- 8 To protect against electrical shock, do not submerge the appliance or allow the power cord to come into contact with water or any other liquid.
- 9 **DO NOT** allow the appliance to be used by children. Close attention is necessary when used near children. This is not a toy.
- 10 Never leave an appliance unattended when in use.
- 11 Appliance accessories are not intended to be used in the microwave as it may result in damage to the accessories.
- 12 Turn the appliance Off and remove the power cord from the electrical outlet when not in use, before assembling or disassembling parts and before cleaning. To unplug, grasp the plug and pull from the electrical outlet. Never pull from the power cord.
- 13 **DO NOT** abuse the power cord. Never carry the appliance by the power cord or yank it to disconnect from electrical outlet; instead grasp the plug and pull to disconnect.
- 14 **DO NOT** operate any appliance with a damaged cord or plug, or after the appliance malfunctions, has been dropped or damaged in any manner. This appliance has no serviceable parts. Return the appliance to SharkNinja Operating LLC for examination, repair or adjustment.
- 15 **DO NOT** let the power cord hang over the edge of table or counter or touch hot surfaces such as the stove.
- 16 Always use appliance on a dry, level surface.
- 17 Keep hands, hair, clothing, as well as utensils out of container while processing to reduce the risk of severe injury to persons or damage to the appliance. A scraper may be used but only when the appliance is not running.
- 18 Avoid contact with moving parts.
- 19 **DO NOT** attempt to sharpen blades.
- 20 **DO NOT** use the appliance if blade assemblies are bent or damaged.
- 21 To reduce risk of injury, never place the blade assemblies on the base without the pitcher or Nutri Ninja cup properly attached.
- 22 **DO NOT** operate this appliance on or near any hot surfaces (such as gas or electric burner or in a heated oven).
- 23 The use of attachments or accessories including canning jars, not recommended by the manufacturer may result in fire, electric shock or personal injury.
- 24 **DO NOT** remove the container from the motor base while the appliance is in operation.
- 25 To reduce the risk of injury, **NEVER** operate the appliance without the lid in place; **DO NOT** try to defeat the interlock mechanism; make sure that the attachment is properly installed before operating the appliance.
- 26 **DO NOT** expose containers to extreme temperature changes.
- 27 **DO NOT** overfill.
- 28 **DO NOT** operate the appliance empty.
- 29 To reduce the risk of burns, always allow the appliance to cool before taking off parts and before cleaning.
- 30 In the event that the unit overloads, the control panel lights will flash and the unit will shut down. Unplug the appliance and let it cool down for approximately 15 minutes before using again.
- 31 **THIS PRODUCT IS INTENDED FOR HOUSEHOLD USE ONLY.** Do not use this appliance for anything other than its intended use. Do not use outdoors.
- 32 The maximum rating is based on the Stacked Blade Assembly (pitcher) that drives the greatest power and other recommended attachments may draw significantly less power or current.

SAVE THESE INSTRUCTIONS

Contents

Thank you for
purchasing the
Nutri Ninja® |
Ninja® Blender
System with
Auto-iQ™
Technology.

Getting to Know Your Nutri Ninja® Ninja® Blender System with Auto-iQ™ Technology	5
Before First Use	7
Assembly and Use of the Pitcher	8
Assembly and Use of the Food Processor	10
Assembly and Use of the Nutri Ninja® Cups	12
Speed Settings & Uses	13
Care & Maintenance	15
Troubleshooting Guide	16
Replacement Parts	16
Warranty & Registration	18

THIS BOOK COVERS MODEL NUMBER:

BL680A

TECHNICAL SPECIFICATIONS

Voltage:	120V~, 60Hz.
Power:	1500 Watts
Pitcher Capacity:	72 oz. (9 cups, 2.1 L)
MAX Liquid Capacity:	64 oz. (8 cups, 1.9 L)
Bowl Capacity:	64 oz. (8 cups, 1.8 L)
Nutri Ninja® Cup Capacity:	24 oz. (3 cups, 710 mL) 32 oz. (4 cups, 950 mL)



Getting To Know Your Nutri Ninja® | Ninja® Blender System with Auto-iQ™ Technology

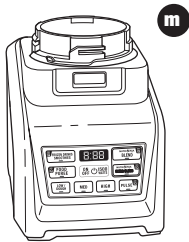
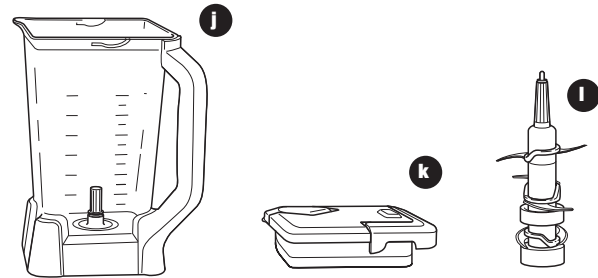
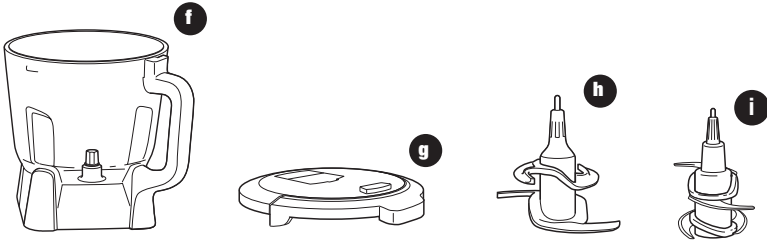
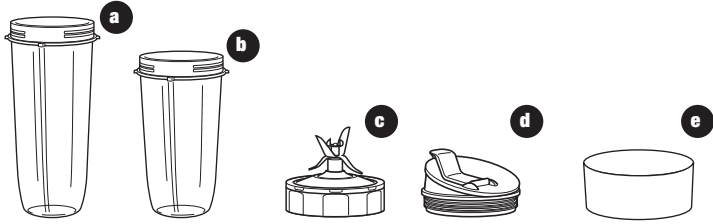

- a** Jumbo Multi-Serve 32 oz. Nutri Ninja® Cup
- b** Regular 24 oz. Nutri Ninja® Cup (x2)
- c** Pro Extractor Blades® Assembly
- d** Sip & Seal® Lids (x3)
- e** Silicone Grip Sleeve (x3)

- f** Food Processor Bowl
- g** Food Processor Lid
- h** Dough Blade Assembly
- i** Chopping Blade Assembly

- j** Pitcher
- k** Pitcher Lid with Locking Handle
- l** Stacked Blade Assembly
- m** Motor Base
- n** Power Cord (not shown)

The Nutri Ninja® | Ninja® Blender System with Auto-iQ™ Technology is a professional, high powered innovative tool with a sleek design and outstanding performance, a true asset to any kitchen. The Nutri Ninja | Ninja Blender System with Auto-iQ Technology features intelligent programs that provides unique pulsing, blending and pausing patterns that do the work for you! Get great results every time with no guesswork required! For best results, be sure to carefully read all the instructions contained in the manual before using this appliance.

Nutri Ninja | Ninja Blender System with Auto-iQ Technology Features:

- 5 Auto-iQ™ settings - Auto-iQ Frozen Drinks/Smoothies, Auto-iQ Food Puree, Nutri Ninja Auto-iQ Blend, Nutri Ninja Auto-iQ Ultra Blend and Auto-iQ Pulse
- Ninja Blade Technology
- BPA Free Pitcher (MAX Liquid Capacity: 64 oz.), Nutri Ninja Cups, Food Processor Bowl and Lids
- Total Crushing® Technology
- LED Control Panel with Timer
- Sturdy, Non-Slip Base
- Smart Lid technology for easy release
- 3 speeds: Low/Dough, Medium, & High
- Nutri Ninja Nutrient & Vitamin Extraction*
- Drip-Free Pour Spout

* Extract a drink containing vitamins and nutrients from fruits and vegetables

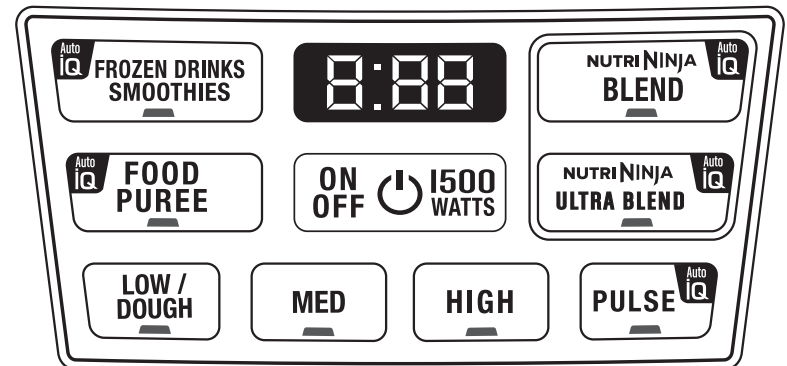

Before First Use

PLEASE KEEP THESE IMPORTANT SAFEGUARDS IN MIND WHEN USING THE APPLIANCE:

IMPORTANT: Make sure that the motor base is plugged in for use.

IMPORTANT: Never add ingredients into the container before placing the blade assembly in first.

IMPORTANT: Blade assemblies are not interchangeable.

IMPORTANT: DO NOT attempt to operate the appliance without the lid on.

IMPORTANT: Never run the appliance empty.

IMPORTANT: Appliance accessories are not intended to be used in the microwave as it may result in damage to the accessories.

⚠ WARNING: Stacked Blade Assembly is sharp and not locked in place. If using the pour spout, ensure the lid is fully locked onto the blender pitcher. Failure to do so will result in a risk of laceration.

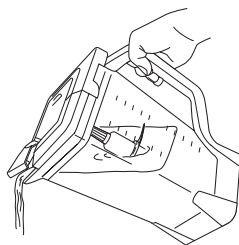

⚠ WARNING: Stacked Blade Assembly is sharp and not locked in place. If pouring with the lid removed, carefully remove the Stacked Blade Assembly first, holding it by the shaft. Failure to do so will result in a risk of laceration.

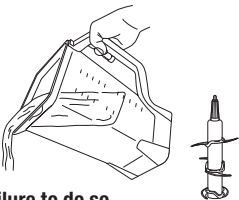

⚠ WARNING: Chopping Blade Assembly is sharp and not locked in place. Before emptying contents carefully remove lid and Chopping Blade Assembly, holding it by the shaft. Failure to do so will result in a risk of laceration.



⚠ CAUTION: Do not immerse the motor base into water or any other liquid.

- 1 Remove all packaging material and labels from the appliance. Separate/remove all parts from each other.
- 2 Wash the lids, pitcher, food processor bowl, Nutri Ninja® cups and Blade Assemblies in warm, soapy water. When washing the blade assemblies, use a dish-washing utensil with a handle to avoid direct hand contact with blades.
- 3 **⚠ CAUTION:** Handle the Blade Assemblies with care when washing, as the blades are very sharp.
- 4 Handle blade assemblies with care to avoid contact with sharp edges. Rinse and air dry thoroughly.
- 5 The pitcher, food processor bowl, Nutri Ninja® cups, lids, and Blade Assemblies, are all dishwasher safe. It is recommended that the lids and blade assemblies be placed on the top rack. Ensure that the blade assemblies are removed from the containers before placing in the dishwasher.
- 6 Wipe the motor base clean with a damp cloth.

Assembly and Use of the Pitcher

- ⚠ WARNING:** Handle the Stacked Blade Assembly with care, as the blades are sharp.
 - ⚠ WARNING:** Remove utensils prior to processing. Failure to remove may cause the pitcher to be damaged or to shatter, which may cause personal injury.
 - ⚠ WARNING:** Never leave the appliance unattended while in use.
 - ⚠ CAUTION:** Do not blend hot liquids, doing so may cause excessive pressure buildup, resulting in risk of the user being burned.
- IMPORTANT:** Make sure that the motor base is plugged in for use.

ASSEMBLY

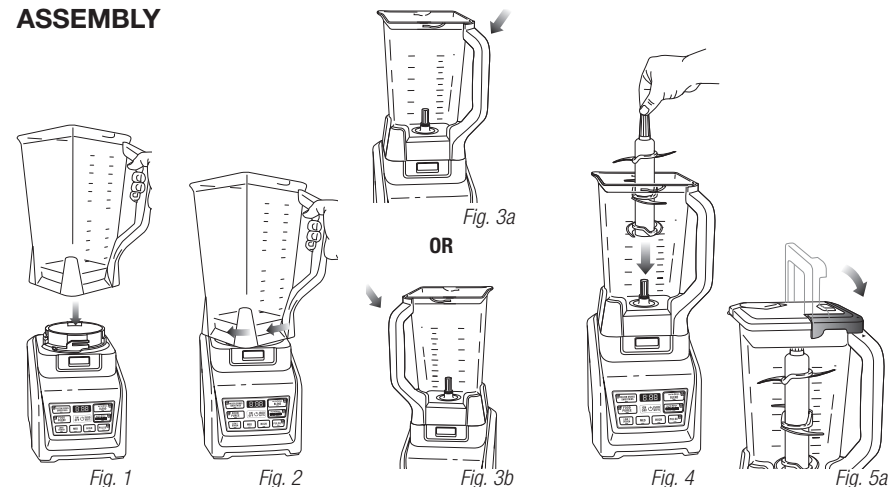

It's best to add the liquid ingredients first and then the dry ingredients.

- 1 Review warning and caution statements above before proceeding to number 2.
- 2 Place the motor base on a clean, dry, level surface such as a counter or table top. Press down on the motor base to make sure that the Suction Cups adhere to the counter or table top.
- 3 Align and lower the Pitcher onto the motor base. (Fig. 1) Handle should be aligned slightly to the right of the "LOCK" symbol on the motor base.
- 4 Rotate the pitcher clockwise until it clicks in place. As the pitcher rotates, it will lower and the safety tabs on the bottom of the pitcher will slide under the safety tabs on the top of the motor base. (Fig. 2)
- 5 The pitcher can be placed on the motor base two ways; the handle can be on the front right corner or the front left corner. (Fig. 3a, Fig. 3b)
- 6 Holding the Stacked Blade Assembly by the top of the shaft, place it onto the drive gear inside the pitcher. Ensure that the Stacked Blade Assembly is seated properly and is standing upright. (Fig. 4)
NOTE: The Stacked Blade Assembly will fit loosely on the drive gear.
- 7 Add the ingredients to the pitcher, making sure that they do not exceed the highest measured marking line on the side of the pitcher.
NOTE: If you need to add additional ingredients while the appliance is processing, open the pour spout cap and pour the ingredients in through the opening.
NOTE: When blending any kind of liquids, such as mixtures of any drinks or smoothies, do not exceed the "MAX" liquid mark (1.9 L) on the Pitcher.
- 8 Holding the lid by the handle in the upright position, place it on top of the Pitcher aligning the triangle (▼) located on the lid with the triangle (▲) located on the Pitcher's handle. (Fig. 5a) Press the handle down until you hear a click. The triangles on the lid and the blender handle **MUST** be aligned in order for the blender to turn on. (Fig. 5b)
IMPORTANT: As a safety feature, the power light (Ⓞ) will flash and the motor will not work if the Pitcher and lid are not installed correctly. When the Pitcher and lid are installed properly, the power light (Ⓞ) will be solid, indicating that the appliance is ready for use.
- 9 Plug the power cord into the electrical outlet and press the power button (Ⓞ).

Assembly and Use of the Pitcher - cont.

USE



Fig. 6

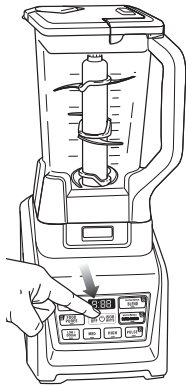

Fig. 7

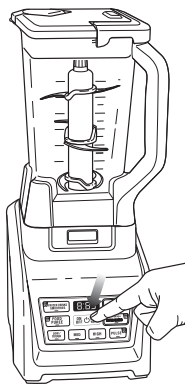

Fig. 8

- 10 Review warning and caution statements on page 8 before proceeding.

NOTE: Nutri Ninja® | Ninja® Blender with Auto-iQ™ Technology can sense which jar is on the motor base. The available function lights will illuminate depending on which jar is placed on the motor base. (Fig. 6)

- 11 Press the power button to turn on the unit. Select the speed or Auto-iQ program that best suits your needs. The Auto-iQ program will stop the appliance automatically at the end of the program. (Fig. 7)

NOTE: Pulse ingredients for even chopping by holding the Auto-iQ Pulse button until your desired consistency is reached.

- 12 To pause the appliance, press the selected speed or Auto-iQ program a second time. When the program is paused, the light on the program button will flash until you press it again to resume the rest of the program.

- 13 When you have reached your desired consistency, stop the appliance by pressing the power button (⏻) and wait for the blade to stop turning. (Fig. 8)

- 14 Turn the pitcher counter clockwise to remove and then lift off the base. (Fig. 9)

REMOVAL

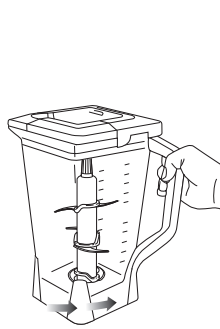

Fig. 9

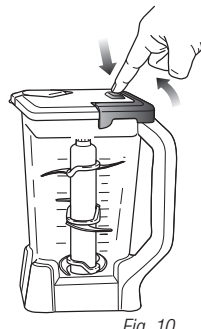

Fig. 10



Fig. 9

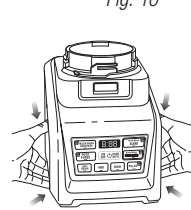

Fig. 11

- 15 **WARNING:** Never insert your hands in the pitcher as the Stacked Blade Assembly is sharp. Always use a spatula to dislodge food that has stuck to the sides of the pitcher.

- 16 Open the pour spout cap and use the spout to empty liquid contents.

- 17 For thicker consistencies, first remove the lid by pressing the release button and pulling the lid handle up to a 90 degree angle to lift lid off the pitcher. Then, carefully remove the Stacked Blade Assembly by the top of the shaft. Place Stacked Blade Assembly away from the work area to avoid accidental contact. Finally, empty contents from the pitcher. (Fig. 10)

- 18 Make sure that the unit is unplugged when not in use.

- 19 To release the motor base from the counter or table top, place your hands underneath both sides of the motor base and gently pull the unit up and towards you. (Fig. 11)

Assembly and Use of the Food Processor

- 1 **WARNING:** Chopping Blade Assembly is sharp and not locked in place. Before emptying contents carefully remove lid and Chopping Blade Assembly, holding it by the shaft. Failure to do will result in risk of laceration.

- 2 **WARNING:** Remove utensils prior to processing. Failure to remove may cause the bowl to be damaged or to shatter, which may cause personal injury.

- 3 **WARNING:** Never leave the appliance unattended while in use.

- 4 **CAUTION:** Do not blend hot liquids, doing so may cause excessive pressure buildup, resulting in risk of the user being burned.

- 5 **CAUTION:** Remove the lid from the bowl upon completion of processing. Some ingredients have the potential to expand after blending resulting in excessive pressure buildup that can pose a risk of injury. **IMPORTANT:** Make sure that the motor base is plugged in for use.



Fig. 1

ASSEMBLY



Fig. 4a



Fig. 4b

OR

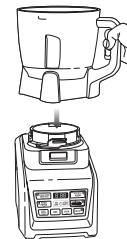

Fig. 2

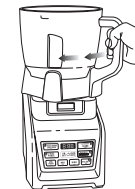

Fig. 3



Fig. 5

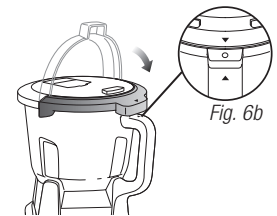

Fig. 6b

NOTE: Nutri Ninja® | Ninja® Blender System with Auto-iQ™ Technology can sense which jar is on the motor base. The function lights will illuminate depending on which jar is placed on the motor base. (Fig. 1)

- 1 Review warning and caution statements above before proceeding to number 2.
- 2 Place the motor base on a clean, dry, level surface such as a counter or table top. Press down on the motor base to make sure that the suction cups adhere to the counter or table top.
- 3 Holding the desired blade assembly by the top of the shaft, place it onto the drive gear inside the bowl. Ensure that the blade assembly is seated properly and is standing upright. (Fig. 2)

NOTE: The blade will fit loosely on the drive gear.

- 3 Align and lower the Processor Bowl onto the motor base. (Fig. 3) Handle should be aligned slightly to the right of the "LOCK" symbol on the motor base.
- 4 Rotate the bowl clockwise until it locks in place, you will hear a click when the lock is engaged. (Fig. 4)
- 5 The bowl can be placed on the motor base two ways; the handle can be on the front right corner or the front left corner. (Fig. 5a, Fig. 5b)

- 6 Add the ingredients to the bowl, making sure that they do not exceed the highest measured marking line on the side of the bowl.

- 7 Holding the lid by the handle in the upright position, place it on top of the Processor Bowl aligning the triangle (▼) located on the lid with the triangle (▲) located on the Processor Bowl handle. (Fig. 6a) Press the handle down until you hear a click. The triangles on the lid and the Processor Bowl handle **MUST** be aligned in order for the blender to turn on. (Fig. 6b)

NOTE: The 64 oz. bowl is not intended for blending drinks. Do not overfill.

- 8 Plug the power cord into the electrical outlet and press the power button (⏻).

NOTE: As a safety feature, the power button (⏻) will flash and the motor will not work if the bowl and lid are not installed correctly. When the bowl and lid are installed properly, the power button (⏻) will be solid, indicating that the appliance is ready for use.

Assembly and Use of the Food Processor - cont.

USE CHOPPING BLADE ASSEMBLY

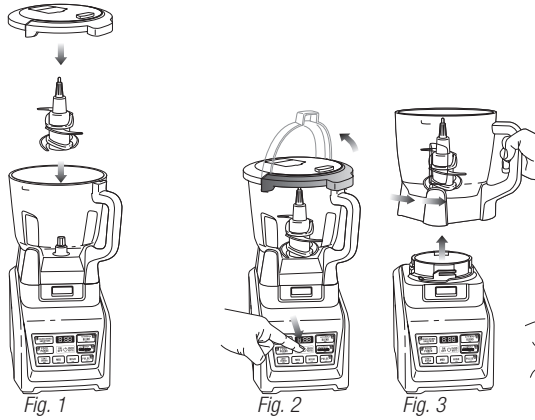

USING THE CHOPPING BLADE ASSEMBLY

- 1 Review warning and caution statements on page 10 before proceeding to number 2.
- 2 Place the motor base on a clean, dry, level surface such as a counter or table top. Press down on the motor base to make sure that the suction cups adhere to the counter or table top.
- 3 Secure the bowl onto the motor base.
- 4 Holding the Chopping Blade Assembly by the shaft, place it onto the gear shaft inside the bowl. Ensure that the Chopping Blade Assembly fits around the gear shaft and that it is standing straight. **(Fig. 1)**
- 5 Add the ingredients and secure the bowl lid onto the bowl.
- 6 Plug the power cord into the electrical outlet and press on the power button (⏻). Select the speed or Auto-iQ™ program that best suits your needs. Pulse ingredients for even chopping by **holding** the Auto-iQ Pulse button until your desired consistency is reached.
NOTE: Please refer to “Speed Settings & Uses” chart for suggested uses and speeds.
- 7 When you have reached your desired consistency, stop the appliance by pressing the power button (⏻) and wait for the blade to stop turning. **(Fig. 2)**
- 8 To remove the lid, press the release button on the lid and pull the lid handle up to a 90° angle. **(Fig. 2)**
- 9 Turn the bowl counter-clockwise and lift it to remove it from the motor base. **(Fig. 3)**
- 10 To release the motor base from the counter or table top, place your hands underneath both sides of the motor base and gently pull the unit up and towards you. **(Fig. 4)**

REMOVAL

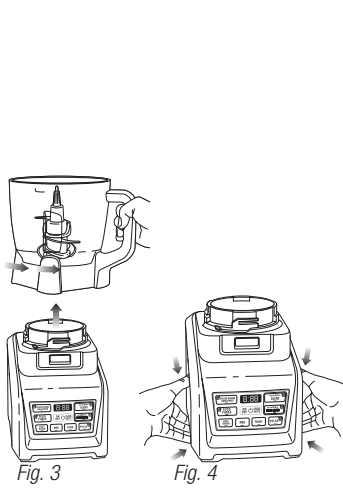

USE DOUGH BLADE ASSEMBLY

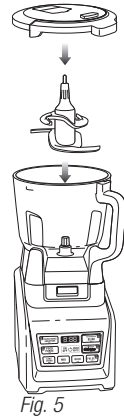

USING THE DOUGH BLADE ASSEMBLY

- 1 Review warning and caution statements on page 10 before proceeding to number 2.
- 2 Place the motor base on a clean, dry, level surface such as a counter or table top. Press down on the motor base to make sure that the suction cups adhere to the counter or table top.
- 3 Secure the bowl onto the motor base.
- 4 Holding the Dough Blade Assembly by the shaft, place it onto the gear shaft inside the bowl. Ensure that the Dough Blade Assembly fits around the gear shaft and that it is standing straight. **(Fig. 5)**
- 5 Add the ingredients and secure the bowl lid onto the bowl.
- 6 Plug the power cord into the electrical outlet and press on the power button (⏻). Select the LOW/DOUGH button and process until ingredients come together to form a mass.
NOTE: Please refer to “Speed Settings & Uses” chart for suggested uses and speeds.
- 7 Once finished making dough, stop the appliance by pressing the power button (⏻) and wait for the blade to stop turning.
- 8 To remove the lid, press the release button on the lid and pull the lid handle up to a 90° angle. **(Fig. 2)**
- 9 Turn the bowl counter-clockwise and lift it to remove it from the motor base. **(Fig. 3)**
- 10 To release the motor base from the counter or table top, place your hands underneath both sides of the motor base and gently pull the unit up and towards you. **(Fig. 4)**

Assembly and Use of the Nutri Ninja® Cups

- ⚠ **WARNING:** Handle the Pro Extractor Blades® Assembly with care, as the blades are sharp.
 - ⚠ **WARNING:** Remove utensils prior to processing. Failure to remove may cause the Nutri Ninja cup to be damaged or to shatter, which may cause personal injury.
 - ⚠ **WARNING:** Never leave the appliance unattended while in use.
 - ⚠ **CAUTION:** Do not blend hot liquids, doing so may cause excessive pressure buildup, resulting in risk of the user being burned.
 - ⚠ **CAUTION:** Remove the Pro Extractor Blades Assembly from the cup upon completion of blending. Some ingredients have the potential to expand after blending resulting in excessive pressure buildup that can pose a risk of injury.
- IMPORTANT:** Make sure that the motor base is plugged in for use.

ASSEMBLY

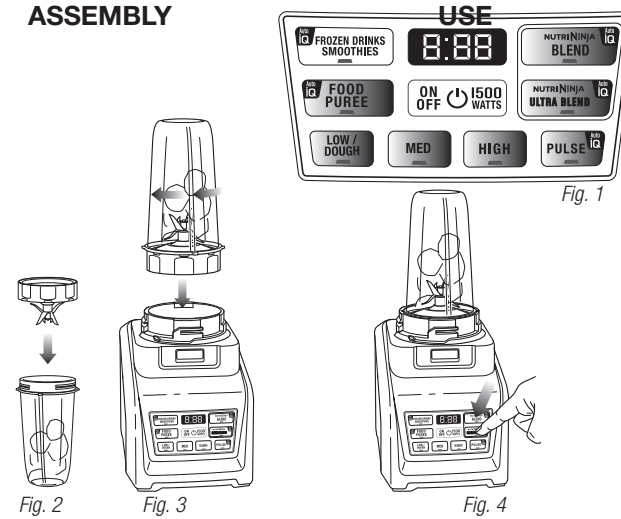

NOTE: Nutri Ninja® I Ninja® Blender with Auto-iQ™ Technology can sense which jar is on the motor base. The available function lights will illuminate depending on which jar is placed on the motor base. **(Fig. 1)**

- 1 Review warning and caution statements above before proceeding to number 2.
- 2 Place the motor base on a clean, dry, level surface such as a counter or table top. Press down on the motor base to make sure that the suction cups adhere to the counter or table top.
- 3 Add ingredients to the Nutri Ninja cup.
- 4 Place the Pro Extractor Blades® onto the cup and tightly screw it on clockwise until you have a good seal. **(Fig. 2)**
- 5 Turn the Nutri Ninja cup upside down and place it onto the motor base. Rotate the Nutri Ninja cup clockwise until it locks in place, you will hear a click when the lock is engaged. **(Fig. 3)**
- 6 Press the power button on, and select the speed or Auto-iQ program that suits your needs. **(Fig. 4)** The Auto-iQ program will stop the appliance automatically at the end of the program.

USE



Fig. 1

REMOVAL

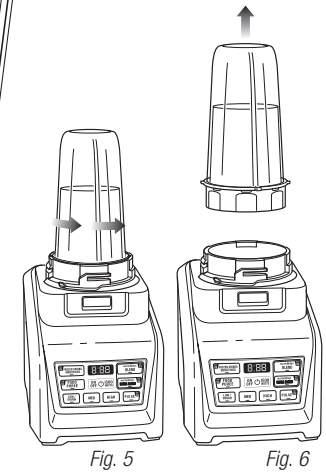

- 7 To pause the appliance, press the selected speed or Auto-iQ program a second time. When the program is paused, the light on the program button will flash until you press it again to resume the rest of the program.
- 8 Once you have reached your desired consistency, stop the appliance by pressing the power button and wait for the blade to stop turning. Turn the Nutri Ninja cup counter-clockwise and pull straight up to remove. **(Fig. 5, Fig. 6)**
NOTE: Do not overfill! To avoid spilling, do not add ingredients past the “Max Liquid” line.
- 9 Turn the cup upright and remove the Pro Extractor Blades by twisting the Pro Extractor Blades counter clockwise.
- 10 Place the Sip & Seal® lid onto the Nutri Ninja cup, twist to seal and enjoy!
- 11 Make sure that the motor base is unplugged when not in use.
- 12 To release the motor base from the counter or table top, place your hands underneath both sides of the motor base and gently pull the unit up and towards you.



Programs, Speed Settings & Uses for the Pitcher

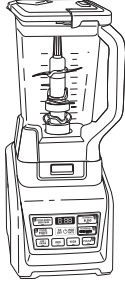

FUNCTION	CONTAINER	BLADE TYPE	SPEED or PROGRAM	TYPE OF FOOD
Frozen Drinks / Ice Crush	Pitcher	Stacked Blade Assembly	Auto-iQ™ Frozen Drinks/ Smoothies	Ice Frozen Drinks Smoothies Milkshakes
Pureeing	Pitcher	Stacked Blade Assembly	Auto-iQ Food Puree	Soups*

* When blending soups or sauces, make sure they're cooled to room temperature first - Ninja® containers are not intended for hot blending.

Programs, Speed Settings & Uses for the Food Processor Bowl

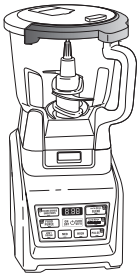

FUNCTION	CONTAINER	BLADE TYPE	SPEED or PROGRAM	TYPE OF FOOD
Mincing	Food Processor Bowl	Chopping Blade Assembly	Auto-iQ Pulse	Onion Garlic Herbs
Kneading and Dough Mixing	Food Processor Bowl	Dough Blade Assembly	Low/Dough	Bread Dough Pie Dough Pizza Dough Pretzel Dough Cookie Dough
Processing	Food Processor Bowl	Chopping Blade Assembly	Auto-iQ Food Puree Low/Dough Medium High	Pâtés Stewed Fruits Dips Apple Sauce Spreads
Emulsifying	Food Processor Bowl	Chopping Blade Assembly	Low/Dough Medium	Salad Dressings Sauces*
Grinding	Food Processor Bowl	Chopping Blade Assembly	Medium	Meat
Grating	Food Processor Bowl	Chopping Blade Assembly	Auto-iQ Pulse High	Grated Cheese Bread Crumbs
Chopping	Food Processor Bowl	Chopping Blade Assembly	Auto-iQ Pulse	Salsa Vegetables Nuts
Batters	Food Processor Bowl	Dough Blade Assembly	Low/Dough	Cake Mixes Batters

* When blending soups or sauces, make sure they're cooled to room temperature first - Ninja containers are not intended for hot blending.

Programs, Speed Settings & Uses for the Nutri Ninja® Cup



FUNCTION	CONTAINER	BLADE TYPE	SPEED or PROGRAM	TYPE OF FOOD
Smoothies	Nutri Ninja® Cup	Pro Extractor Blades® Assembly	Nutri Ninja Auto-iQ™ Blend	Smoothies Protein Drinks
Green Smoothies	Nutri Ninja Cup	Pro Extractor Blades Assembly	Nutri Ninja Auto-iQ Ultra Blend	Frozen Fruits Frozen Vegetables Kale Celery Spinach Seeds Ice
Grating	Nutri Ninja Cup	Pro Extractor Blades Assembly	Auto-iQ Pulse High	Grated Cheese Bread Crumbs
Chopping	Nutri Ninja Cup	Pro Extractor Blades Assembly	Auto-iQ Pulse High	Salsa Vegetables

HOW TO CLEAN

⚠ CAUTION: Make sure that the motor base is unplugged from the power source before inserting or removing any blade assembly and before cleaning.

⚠ CAUTION: DO NOT immerse the motor base into water or any other liquid.

1 Separate/remove all parts from each other.

2 **Hand Washing:** Wash the lids, pitcher, food processor bowl, Nutri Ninja® cup, and blade assemblies in warm, soapy water. When washing the blade assemblies, use a dish-washing utensil with a handle to avoid direct hand contact with blades. Handle blade assemblies with care to avoid contact with sharp edges. Rinse and air dry thoroughly.

Dishwasher: The containers, lids, blade assemblies and attachments are all dishwasher safe. The lids and blade assemblies are top rack dishwasher safe. Ensure that the blade assemblies are removed from the containers before placing in the dishwasher.

⚠ WARNING: Handle the Blade Assemblies with care when washing, as the blades are sharp. Contact with the blades' edges can result in laceration.

3 Wipe the motor base clean with a damp cloth.

Please call customer service if any servicing needs to be performed on the appliance at 1-877-646-5288.

HOW TO STORE

1 Store the Nutri Ninja® | Ninja® Blender System with Auto-iQ™ Technology upright with the blade assembly inside the corresponding container with the lid secured on top. Do not place anything on top. Store the rest of the attachments in a safe place where they will not be damaged and won't cause harm. Wrap the power cord around the cord wrap on the back of the motor base.

RESETTING THE MOTOR THERMOSTAT

The Nutri Ninja | Ninja Blender System with Auto-iQ Technology features a unique safety system which prevents damage to the unit's motor and drive system should you inadvertently overload your appliance. **If the appliance is being overloaded, the motor will stop. Allow the appliance to cool for approximately 15 minutes.** To reset the appliance, follow the resetting procedure below:

1 Unplug the appliance from the electrical outlet.

2 Remove and empty the container and ensure that no food is jamming the Blade Assembly or attachments.

3 Allow the appliance to cool for approximately 15 minutes.

4 Re-install the container onto the base and re-plug the appliance into the electrical outlet.

5 Proceed to use the appliance as before making sure not to exceed the recommended maximum capacities.

PROBLEMS	POSSIBLE REASONS & SOLUTIONS
Motor Doesn't Start or Blade Assembly Doesn't Rotate.	<p>Make sure the container is securely locked on the motor base.</p> <p>Make sure the lid is securely on the container in the correct position (align arrows).</p> <p>The appliance is turned "Off". Press the power button (⏻) to turn "On".</p> <p>Check that the plug is securely inserted into the electrical outlet.</p> <p>Check the fuse or circuit breaker.</p> <p>The unit has overloaded. The appliance will stop and the power light will flash. Unplug and wait approximately 15 minutes before using again.</p> <p>The unit has overheated. Unplug and wait approximately 15 minutes before using again.</p> <p>Check to make sure the unit is not overloaded.</p>
Food is Unevenly Chopped.	<p>Either you are chopping too much food at one time, or the pieces are not of even size and processing smaller amounts per batch.</p>
Food is Chopped Too Fine or is Too Watery.	<p>The food has been over processed. Use Auto-iQ™ Pulse button for controlled processing.</p>
Food Collects On Lid or On the Sides of the Container.	<p>The mixture is too thick. Add more liquid.</p>
You Cannot Achieve Snow From Solid Ice.	<p>Do not use ice that has been sitting out or has started to melt. Use ice straight from the freezer.</p> <p>Start with a few pulses and then go to a continuous blending cycle.</p>
Motor Base Won't Stick to Counter or Table Top.	<p>Make sure surface and suction feet are wiped clean. Suction feet will only stick to smooth surfaces. Suction feet WILL NOT stick on some surfaces such as, wood, tile and non-polished finishes.</p> <p>DO NOT attempt to use appliance when the motor base is stuck to a surface that is not secure, (cutting board, platter, plates, etc.).</p>
You get an "Err" Message	<p>Your Ninja® is able to detect which jar is on the base. You may be trying to use a program that is not designed for the jar you have installed. The programs will light up indicating which programs are available for each jar.</p>
You have a blinking red light	<p>The unit is not installed properly. For your safety the unit will only be able to be turned on when it is properly assembled. Please refer to the assembly pages of this inspiration guide for assistance.</p>

Replacement Parts

ORDERING REPLACEMENT PARTS

To order additional parts and attachments, please visit our website: www.ninjakitchen.com or feel free to contact customer service: **1-877-646-5288**.

ONE (1) YEAR LIMITED WARRANTY

SharkNinja Operating LLC warrants this product to be free from material defects and workmanship for a period of one (1) year from the date of purchase when utilized for normal household use, subject to the following conditions, exclusions and exceptions.

The liability of **SharkNinja Operating LLC** is limited solely to the cost of the repair or replacement of the unit at our option. This Limited Warranty does not cover normal wear of parts and does not apply to any unit that has been tampered with or used for commercial purposes. This Limited Warranty does not cover damage caused by misuse, abuse, negligent handling or damage due to faulty packaging or mishandling in transit. This Limited Warranty does not cover damage or defects caused by or resulting from damages from shipping or repairs, service or alteration to the product or any of its parts, which have been performed by a repair person not authorized by **SharkNinja Operating LLC**.

If your appliance fails to operate properly while in use under normal household conditions within the Limited Warranty period, you may return the complete appliance and accessories with proof of purchase and date, freight prepaid. For Customer Service support, call 1-877-646-5288 or visit our website www.ninjakitchen.com.

If the appliance is found by **SharkNinja Operating LLC** to be defective, in **SharkNinja Operating LLC's** sole discretion, we will repair or replace it free of charge. Proof of purchase date and a check made payable to **SharkNinja Operating LLC** in the amount of \$19.95 to cover the cost of return shipping and handling must be included.*

This Limited Warranty is extended to the original purchaser of the unit and excludes all other legal, implied and/or conventional warranties. The responsibility of **SharkNinja Operating LLC** if any, is limited to the specific obligations expressly assumed by it under the terms of this Limited Warranty. In no event is **SharkNinja Operating LLC** liable for incidental or consequential damages to anyone of any nature whatsoever. Some states do not permit the exclusion or limitation of incidental or consequential damages, so the above may not apply to you.

This Limited Warranty gives you specific legal rights, and you may also have other rights which vary from state to state or from province to province.

***IMPORTANT: Carefully pack item to avoid damage in shipping. Be sure to include proof of purchase date and to attach tag to item before packing with your name, complete address and phone number with a note giving purchase information, model number and what you believe is the problem with the item. We recommend you insure the package (as damage in shipping is not covered by your Limited Warranty). Mark the outside of your package "ATTENTION CUSTOMER SERVICE".**

PRODUCT REGISTRATION

Please visit www.ninjakitchen.com or call **1-877-646-5288** to register your new Ninja® product within ten (10) days of purchase. You will be asked to provide the store name, date of purchase and model number along with your name and address.

The registration will enable us to contact you in the unlikely event of a product safety notification. By registering you acknowledge to have read and understood the instructions for use, and warnings set forth in the accompanying instructions.



SharkNinja Operating LLC
US: Newton, MA 02459
CAN: Ville St-Laurent, QC H4S 1A7
1-877-646-5288
www.ninjakitchen.com

Ninja, Nutri Ninja, Pro Extractor Blades and **Sip & Seal** are registered trademarks of SharkNinja Operating LLC.

Auto-iQ and **Total Crushing** are trademarks of SharkNinja Operating LLC.

Illustrations may differ from actual product. We are constantly striving to improve our products, therefore the specifications contained herein are subject to change without notice.

For SharkNinja U.S. Patent information visit www.sharkninja.com/USPatents.

© 2016 SharkNinja Operating LLC
BL680A_30_E_160126_2
PRINTED IN CHINA