

Please make sure to read the enclosed Ninja® Owner's Guide prior to using your unit.

NINJA[®]

GROUNDS & PODS

DUALBREW

SPECIALTY COFFEE SYSTEM

**QUICK
START
GUIDE**

+ RECIPES

BEFORE YOUR FIRST BREW

To prime your brewer:

- 1 Plug it into the wall and turn it on.
- 2 Fill the water reservoir to the Full line with fresh water and place it on the base.
- 3 Remove the Ninja Pod Adapter and slide the Sliding Lid into the closed position. (Refer to the steps on page 3)
- 4 Place the empty carafe under the brew basket and run a Full Carafe, Classic Brew.

Once the brew is complete, discard the water and you're ready to brew.

If you live in a high-altitude area, running a calibration brew is required. Not running a high-altitude calibration brew in a high-altitude area will result in excessive steaming during brewing. Refer to page 7 of the Owner's Guide for instructions on running a high-altitude calibration brew.

HERE'S WHAT'S IN THE BOX

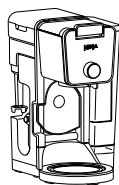

NINJA DUALBREW



NINJA POD ADAPTER

Comes fully installed in the brewer. Always ensure to insert it over the brew basket when brewing pods.



BREW BASKET

Comes fully installed in the brewer. It must always be inserted when brewing pods or grounds.



60 OZ. THERMAL CARAFE

Keeps coffee hot, **no warming plate required.**



FROTHER WHISK

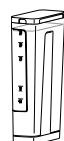

60 OZ. REMOVABLE WATER RESERVOIR



NINJA SMART SCOOP™

Use this to measure coffee grounds.

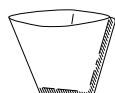

PAPER FILTER KIT

Fold along the seams before inserting firmly into brew basket.

FILLING THE WATER RESERVOIR

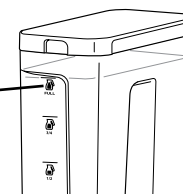

FILL TO THE FULL LINE

Fill up to, but do not exceed, the Full line.

LOCKING AND REMOVING THE NINJA POD ADAPTER

The Ninja DualBrew Pro Coffee System comes with a unique Ninja Pod Adapter already installed on the brewer. Always ensure the adapter is installed over the brew basket.

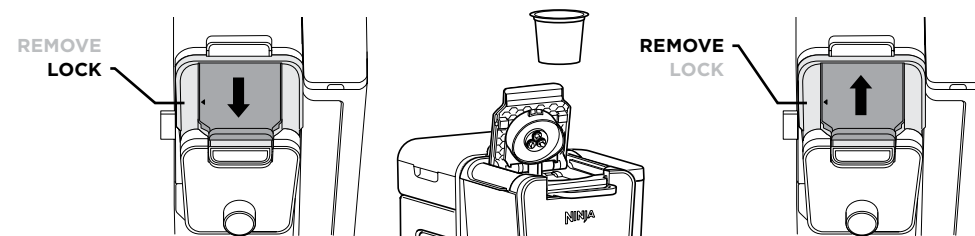

1. Once the adapter is installed in the brewer, make sure the position indicator on the left side of the adapter is aligned with LOCK by pulling the handle toward you. Then, lift to open the handle, insert a pod, firmly push down on the handle to pierce the pod, and begin programming your brew.
2. To uninstall the adapter, remove the used pod and close the handle. Push the handle away from you so the position indicator is in the REMOVE position. Then, using the edges on the left and right, lift the adapter out of the brewer.

NOTE: The Ninja Pod Adapter is compatible only with K-Cup pods. It is not compatible with reusable K-Cup filters. If using ground coffee, use the Grounds mode with a paper or permanent filter (sold separately) to brew a single-serve size.

SLIDING LID

The sliding lid is used only when brewing loose coffee grounds. To use it, first remove the Ninja Pod Adapter. Then, using the handle on top of the brewer, slide the lid toward you until it firmly clicks into place.



POSITIONING THE WATER RESERVOIR

The water reservoir can be positioned to the right or along the back of the brewer to optimize counter space.

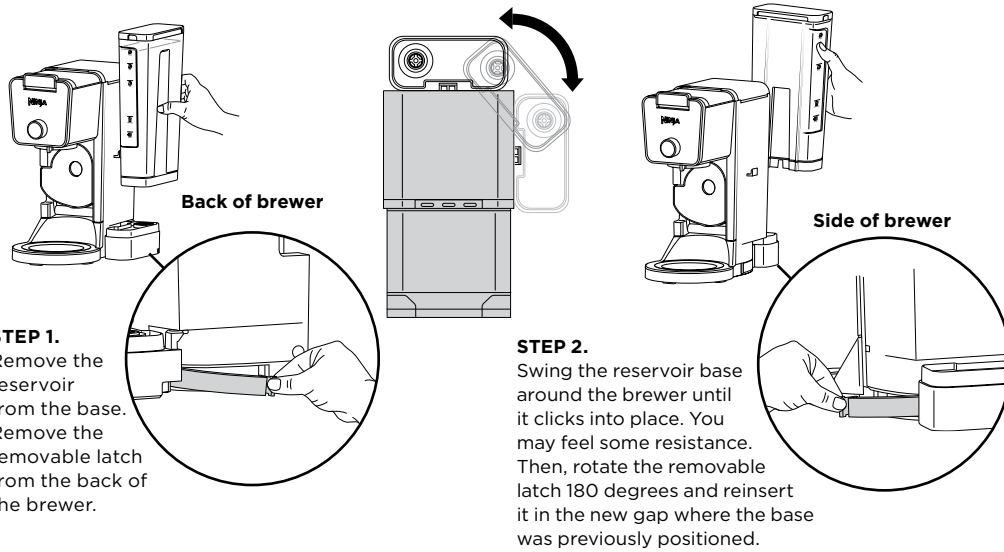

CUP, MUG, OR CARAFE



NINJA SMART SCOOP™

The **Ninja Smart Scoop** is used for accurately measuring coffee grounds. The numbers beside the icons show the number of level scoops recommended for each brew size.

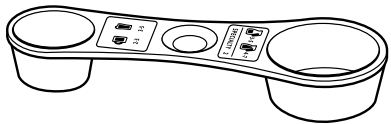

IMPORTANT: Always measure with level scoops of a medium grind size. Use fewer scoops when brewing decaf coffee. **DO NOT** use a paper filter in conjunction with a permanent filter.

SERVING SIZE	NINJA SMART SCOOP
GROUND COFFEE	
	2-3 small scoops
	3-5 small scoops
	3-5 big scoops
	4-7 big scoops
Specialty 4 oz.	2 big scoops

BREW BASKET AND NINJA POD ADAPTER ASSEMBLY

BREW BASKET MUST BE INSERTED WHEN USING GROUNDS OR PODS.



BREW BASKET

Must always be inserted when brewing grounds or pods.

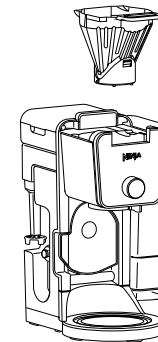

INSERT FILTER

Fold the #4 paper cone filter along the seams, open the top fully, then insert filter firmly into the brew basket.

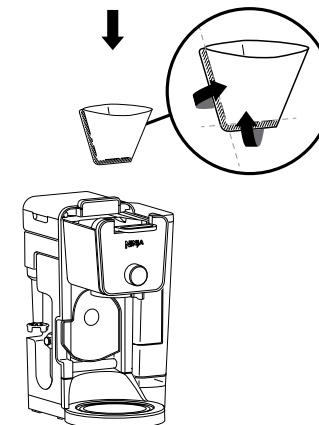

BREW BASKET

Must always be inserted when brewing pods or grounds. Do not insert a filter.

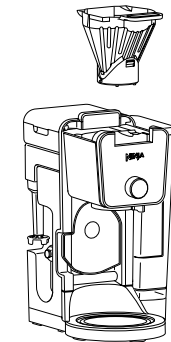

NINJA POD ADAPTER

Ensure adapter is in the REMOVE position before installing. Always insert over the brew basket when brewing pods.

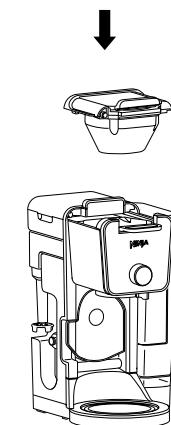

1 CHOOSE A METHOD

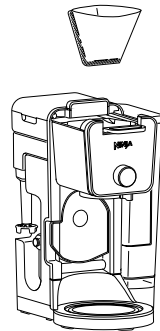

Ensure the brew basket is installed and the Ninja Pod Adapter is removed. Then, insert a paper filter in the basket (refer to steps on pages 3 and 5).

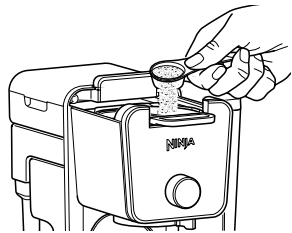

Use the Ninja Smart Scoop™ to add your desired amount of coffee grounds (refer to the Smart Scoop section on page 4).

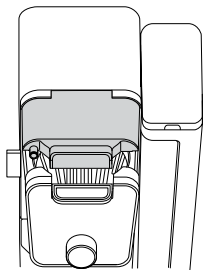

Slide the sliding lid forward, ensuring it is completely closed.

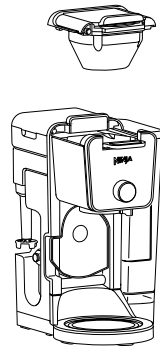

Ensure the brew basket and Ninja Pod Adapter are installed in the brewer (refer to steps on pages 3 and 5).

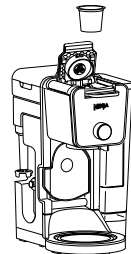

Lift adapter handle to reveal pod holder and insert a pod.

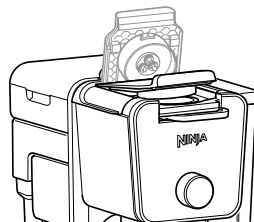

Firmly push down on the handle to pierce the pod. Some noise and resistance is normal.

2 CHOOSE A SIZE



*Approximate brew volumes based on Classic brew. Rich brew will produce slightly less output. Refer to the Approximate Brew Volumes chart in the Owner's Guide for more information.

	8 oz.		15 oz.		37 oz.
	10 oz.		18 oz.		46 oz.
	12 oz.		28 oz.		55 oz.

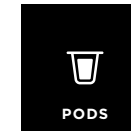

*Approximate brew volumes based on Classic brew. Rich brew will produce slightly less output. Refer to the Approximate Brew Volumes chart in the Owner's Guide for more information.

Pods cannot brew in carafe sizes.

	6 oz.		10 oz.
	8 oz.		12 oz.

NOTE: Make sure to use a vessel that is big enough for the brew size you select.

3 CHOOSE A BREW



Smooth, well-balanced flavor.



Richer than classic, with more intense flavor that stands up to milk, cream, or flavoring.



Specially designed to brew hot over ice for freshly brewed iced coffee that is not watered down.
Always fill your vessel to the top with ice cubes before brewing Over Ice.



A super-rich concentrate that allows you to make coffee-based drinks like cappuccinos and lattes.
Will only brew 4 oz.

NOTE: DO NOT use glassware on any brew setting.

4 BREW



Press the **START BREW** button to start brewing. There will be an illuminating progress bar on the display to track the status of your brew.

THE BREW MAY PAUSE ONCE OR MULTIPLE TIMES DURING THE BREW CYCLE. THAT'S OK. Pausing allows the coffee grounds to fully extract and unlock the full flavor of the brew style.

NOTE: Ensure the drip stop is open before starting your coffee brew.

DRIP STOP

The drip stop is used to close off the brew basket to prevent any coffee from dispensing. You will need to manually open and close the drip stop by moving the handle to your desired position. The drip stop can be closed and reopened at any point before, during, or after a brew.

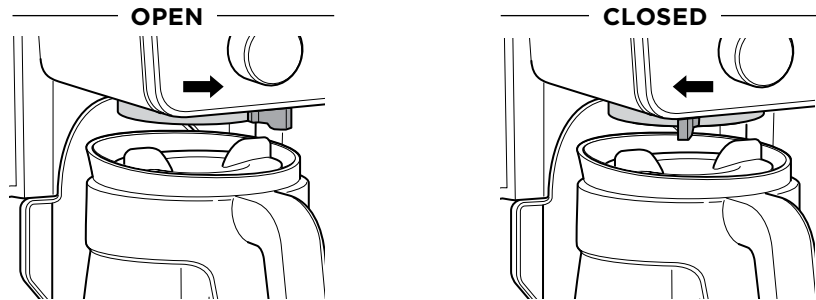

CAN'T WAIT FOR THAT FIRST CUP?

Close the drip stop to pause the brew cycle, and pour yourself a cup. Then, reopen the drip stop to continue the brew.

STOP THE DRIPS AFTER A BREW

At the end of a brew, close the drip stop to prevent coffee dripping from the brew basket and Ninja® Pod Adapter.

FROTHING

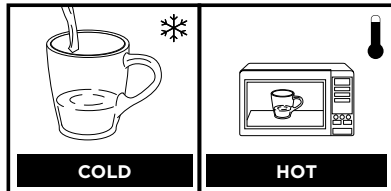

THE INTEGRATED FROTHER DOES NOT HEAT MILK.

1. Add milk to your cup until it is about 1/3 full.

* For cold froth, continue to Step 2.

🌡 For hot froth, microwave for 45-60 seconds.



2. Swing the arm of the frother toward the front of the brewer. Install the frother whisk by twisting it to the right.

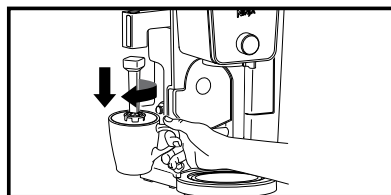

3. Hold the cup under the frother and submerge the whisk just below the surface of the milk. Press and hold the button on top of the frother and froth for 30-45 seconds.

4. Remove the frother whisk by twisting it to the left. Keep your cup below the whisk while you carry it to your sink or dishwasher for easy cleaning.



WARNING: To avoid contact with steam and hot surfaces, **DO NOT** reach across top of brewer to froth.

GUIDE TO KEEPING COFFEE HOT

The type of cup you brew into can greatly influence the temperature of your coffee when drinking.

	CERAMIC CUP			PAPER CUP
Cup Temperature	Room temperature	Pre-warmed with hot water	Pre-warmed in microwave with milk	Room temperature
Drinking Temperature	Hot 	Hotter 	Hotter 	Hottest
Why is there a difference?	A cold ceramic mug will steal heat from the coffee as it warms itself up.	If the mug is already warm, it will not steal as much heat from the coffee.	Just like your cold mug, cold milk lowers the temperature of your coffee.	Unlike a ceramic mug, a thinner paper cup does not steal substantial heat from the coffee.

NOTE: DO NOT put the carafe in the microwave.

CAPPUCCINO-STYLE COFFEE



Brew: Specialty **Makes:** 1 serving (12-ounce cup)

INGREDIENTS

2 Ninja Big Scoops
(4 tablespoons)
ground coffee
½ cup milk
Sweetener, as desired
Ground cinnamon,
for garnish

DIRECTIONS

1. Following the measurement provided, place the ground coffee into the filter.
2. Pour milk into a 12-ounce mug. Microwave for 45–60 seconds, then froth for 30 seconds.
3. Set the mug containing frothed milk in place to brew.
4. Press the BREW STYLE button to select SPECIALTY, then press the START BREW button to begin the brew.
5. When brew is complete, sweeten and garnish as desired.

ICED NUTTY COCOA LATTE



Brew: Specialty **Makes:** 1 serving (18-ounce cup)

INGREDIENTS

2 Ninja Big Scoops
(4 tablespoons)
ground coffee
2 tablespoons chocolate syrup,
plus more for garnish
1 tablespoon caramel syrup,
plus more for garnish
2 cups ice
½ cup milk
1 tablespoon peanut butter

DIRECTIONS

1. Following the measurement provided, place the ground coffee into the filter.
2. Add chocolate syrup, caramel syrup, and ice to an 18-ounce cup and set in place to brew.
3. Press the BREW STYLE button to select SPECIALTY, then press the START BREW button to begin the brew.
4. While coffee is brewing, place milk and peanut butter in a large mug, stir to combine, then microwave for 45–60 seconds.
5. When brew is complete, stir to combine.
6. Froth milk mixture for 30 seconds, then gently pour over coffee. Garnish as desired.

NINJA[®]

GROUNDS & PODS

DUALBREW

SPECIALTY COFFEE SYSTEM

For questions or to register your product, contact us at
1-877-646-5288 or visit us online at ninjakitchen.com



@ninjakitchen

CFP355A_QSG_MP_REV_MV5

© 2022 SharkNinja Operating LLC

NINJA is a registered trademark of SharkNinja Operating LLC.

NINJA SMART SCOOP is a trademark of SharkNinja Operating LLC.

All other marks, including KEURIG and K-CUP, are trademarks of their respective owners.

K-CUP is a registered trademark of Keurig Green Mountain, Inc. Use of K-CUP trademark does not imply any affiliation with or endorsement by Keurig Green Mountain, Inc.