







NINJA WOODFIRE™ OUTDOOR GRILL OG705A | Owner's Guide

IMPORTANT SAFEGUARDS

OUTDOOR HOUSEHOLD USE ONLY. READ ALL INSTRUCTIONS BEFORE USE.

	Read and review instructions to understand operation and use of product.
	Indicates the presence of a hazard that can cause personal injury, death or substantial property damage if the warning included with this symbol is ignored.
	Avoid contact with hot surface. Always use hand protection to avoid burns.
	For outdoor use only.

⚠ WARNING Failure to follow these instructions could result in electric shock, fire or burn hazard which could cause property damage, personal injury, or death. When using electrical appliances, basic safety precautions should always be followed, including the following:

- 1 To eliminate a choking hazard for young children, discard all packaging materials immediately upon unpacking.
- 2 This appliance is for outdoor household use only. **DO NOT** use indoors. **DO NOT** use this appliance for anything other than its intended use. **DO NOT** use in moving vehicles or boats. Use only in well ventilated area. **DO NOT** place on or near a hot gas or electric burner, or in a heated oven. Misuse may cause injury.
- 3 This appliance can be used by persons with reduced physical, sensory, or mental capabilities or lack of experience and knowledge if they have been given supervision or instruction concerning use of the appliance in a safe way and understand the hazards involved.
- 4 **ALWAYS** ensure the appliance is properly assembled before use. Ensure the grill plate is correctly inserted and securely locked into position. **DO NOT** use without side handles attached.
- 5 To avoid property damage from flame or heat maintain a minimum distance of 3 feet from rear, sides and top to walls, rails, or other combustible constructions. In windy conditions or when excessive grease from food is present, flames may appear. Keep lid closed during such an event.
- 6 Ensure the surface is level, stable, clean and dry. **DO NOT** place the appliance near the edge of the surface the grill is placed on during operation.
- 7 To ensure continued protection against electric shock, connect to properly grounded outlets only. **DO NOT** immerse cord, plugs, or main unit housing in water or other liquid.
- 8 Keep the appliance and its cord out of reach of children. A short power-supply cord is provided to reduce the risk of children less than 8 years grabbing the cord or becoming entangled and to reduce the risk of people tripping over a longer cord. **DO NOT** allow the appliance to be used near, cleaned, or maintained by children. Close supervision is necessary when used near children.
- 9 When using an extension cord it must be specific for use outdoors and must have a "W" marking and tag stating: **SUITABLE FOR USE WITH OUTDOOR APPLIANCES**. Extension cord shall not exceed 25-foot maximum and no less than 14-gauge.
- 10 Longer detachable power-supply cord or extension cords are available and may be used if care is exercised in their use.
- 11 If a longer detachable power-supply cord or extension cord is used: The marked electrical rating of the cord set or extension cord should be at least as great as the electrical rating of the appliance. The cord should be arranged so that it will not drape over the countertop or tabletop where it can be pulled on by children or tripped over unintentionally. The cord set or extension cord should be a grounded-type 3-wire cord.

IMPORTANT SAFEGUARDS

OUTDOOR HOUSEHOLD USE ONLY. READ ALL INSTRUCTIONS BEFORE USE.

- 12 To avoid burn injury, **ALWAYS** use pellet scoop when adding pellets to smoker box. **DO NOT** add pellets by hand. Make sure the lid of the smoke box is fully closed to prevent flames from escaping out of the smoke box.
- 13 Pellets may continue to burn after cook time is complete. **DO NOT** touch or remove the smoke box until the grill has stopped smoking, pellets have completely burnt out, and the smoke box has cooled.
- 14 To avoid personal injury and burns allow to cool before cleaning, disassembly, putting in or taking off parts and storage.
- 15 **DO NOT** allow pellets to overflow the pellet box. Doing so will introduce oxygen leading to combustion, flame, and damage to the unit which may result in burn injury.
- 16 **DO NOT** touch hot surfaces. Appliance surfaces are hot during and after operation. To prevent burns or personal injury, **ALWAYS** use protective hot pads or insulated oven mitts and use available handles and knobs.
- 17 **DO NOT** touch accessories during or immediately after cooking. The basket will become extremely hot during the cooking process. Avoid physical contact while removing the accessory from the appliance. To prevent burns or personal injury **ALWAYS** use care when interfacing with product. Recommend use of long handed utensil and protective hot pads or insulated oven mitts.
- 18 **ALWAYS** ensure the grill is completely cool before removing the cooking plates, disposing of hot grease or moving the to avoid burns or personal injury.
- 19 Regularly inspect the appliance and power cord. **DO NOT** use the appliance if there is damage to the power cord or plug. If the appliance malfunctions or has been damaged in any way, immediately stop use and call Customer Service.
- 20 **NEVER** connect this appliance to an external timer switch or separate remote-control system.
- 21 **DO NOT** place appliance and let cord hang over edges of tables, counters or touch hot surfaces.
- 22 Only use recommended accessories included with this appliance or authorized by SharkNinja. The use of accessories or attachments not recommended by SharkNinja may cause a risk of fire or injury.
- 23 Before placing any accessory into the cooker, ensure they are clean and dry.
- 24 **DO NOT** move the appliance when in use.
- 25 **DO NOT** cover the air intake vent or air outlet vent while unit is operating. Doing so will prevent even cooking and may damage the unit or cause it to overheat.
- 26 **DO NOT** place anything on top of the product when the hood is closed during use and stored.
- 27 Ensure the grill plate is correctly inserted and securely locked into position.
- 28 **DO NOT** use this appliance for deep-frying.
- 29 Use care when opening the grill to avoid burns. Some foods may cause oils or grease to splash
- 30 Socket voltages can vary, affecting the performance of your product. To prevent possible illness, **ALWAYS** use an external food thermometer to check that your food is cooked to the recommended temperatures.
- 31 Use **ONLY** genuine food grade wood pellets from Ninja in your unit.

IMPORTANT SAFEGUARDS

OUTDOOR HOUSEHOLD USE ONLY. READ ALL INSTRUCTIONS BEFORE USE.

- 32 **NEVER** use heating fuel pellets, hardwood, charcoal, liquid fuels, or any other combustible material in the Smoker.
- 33 Keep hands and face away from Smoker Box when unit is in use and hot.
- 34 **ALWAYS** keep a fire extinguisher accessible while operating the smoker.
- 35 **ALWAYS** store wood pellets in a dry location, away from heat-producing appliances and other fuel containers.
- 36 Keep your grill clean and do not allow excess grease or ash to collect inside or on the smoke box and cartridge. Doing so significantly increases the chances of a grease fire and additional smoke which can taint the flavor of your food.
- 37 Please refer to the Cleaning & Maintenance section for regular maintenance of the appliance.
- 38 To disconnect, press the power button to turn the unit off, then unplug from socket when not in use and before cleaning.
- 39 **DO NOT** clean this product with a water spray or the like.
- 40 **DO NOT** clean with metal scouring pads. Pieces can break off the pad and touch electrical parts, creating a risk of electric shock.
- 41 Store indoors when not in use - out of reach of children.
- 42 **DO NOT** keep uncovered grill exposed to elements. **ALWAYS** use grill cover when stored outdoors.
- 43 **DO NOT** place appliance on hot surfaces, near hot gas or electric burner, in a heated oven, or on a stovetop.

SAVE THESE INSTRUCTIONS.

PARTS & ACCESSORIES

- A Grill Grate
- B Crisper Basket
- C Smoke Box
- D Grease Tray
- E Left and Right Assembly Handles
- F Socket Head Cap Screw 3.5mm x 16mm (4x) (pre-assembled on handles)
- G Allen Wrench
- H Pellet Scoop
- I Assembled Main Unit (power cord not shown)
- J Hood
- K Control Panel
- L Flat Top Griddle Plate
- M Grill Cover

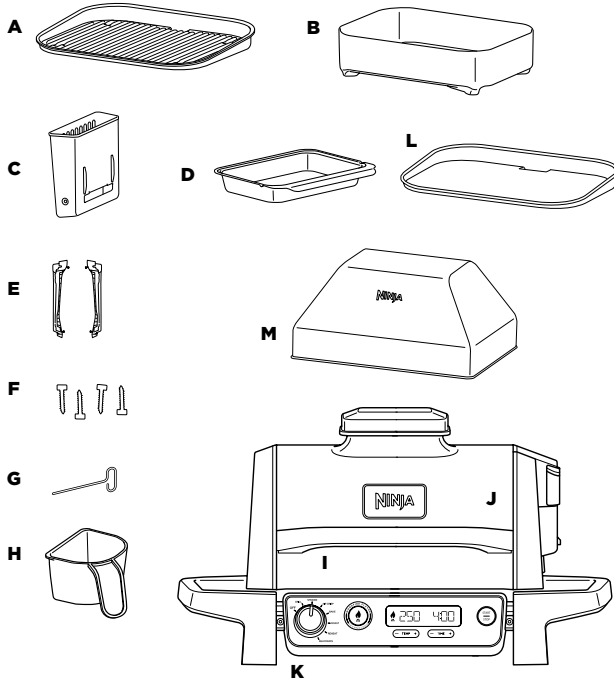

(accessories may vary per model)

BEFORE FIRST USE

- 1 Remove all packaging material, and tape from the unit.
- 2 Remove all accessories from the package and read this manual carefully. Please pay particular attention to operational instructions, warnings, and important safeguards to avoid any injury or property damage.
- 3 Wash the grill grate, flat top griddle plate, and crisper basket in warm, soapy water, then rinse and dry thoroughly. The grill grate, flat top griddle plate, crisper basket, and base unit are **NOT** dishwasher safe. **NEVER** clean the main unit in the dishwasher.

NOTE: The base liner underneath the bottom heating element may have some visible discoloration. This is a result of our normal manufacturing process. The unit has not been previously used.

- 4 **DO NOT** use abrasive brushes or sponges on the cooking surfaces, as it will cause damage to the coating.

We recommend placing all accessories inside the grill and running it on GRILL, temp set to HI for 20 minutes without adding food. This removes any residues. This is completely safe and not detrimental to the performance of the grill.

BEFORE FIRST USE - CONT'D

HANDLE INSTALLATION

- 1 Ensure the correct handle is being used on the left and right side. (Refer to Fig. A and note that the handles have L and R stickers on the underside.) An Allen wrench is taped onto the left handle (see Fig. A).
- 2 Place unit at edge of table (Fig. B) OR, with lid still taped down, carefully place grill upside down by holding the sides of the unit and the lid down. If tape has been removed, remove all accessories from the grill and, holding the sides of the unit and the lid down, place grill on top polyfoam piece to protect unit (Fig. C).
- 3 Align each handle with tabs on base, then push up to set each handle in place (Fig. D). Use included Allen wrench to tighten pre-assembled screws (2x) on each handle (Fig. E).

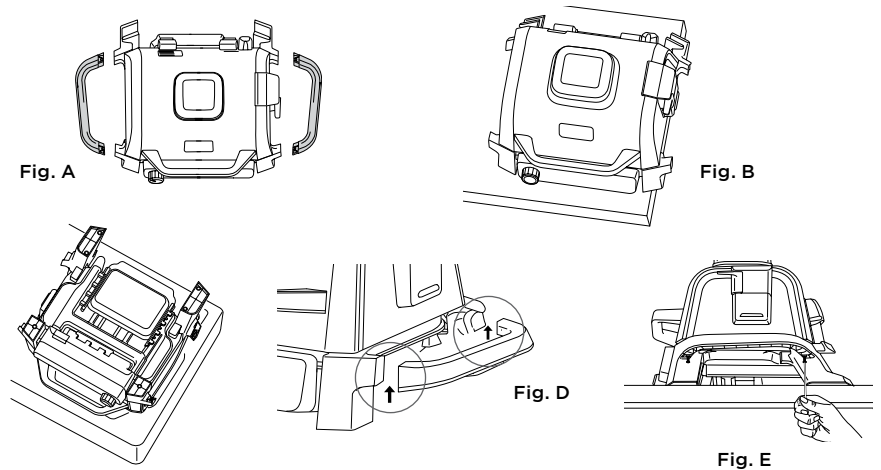

EXTENSION CORD

- 1 Connect to properly 3-prong grounded GFI outlets only.
- 2 Use only outdoor extension cords 25-feet maximum and no less than 14-gauge or 50-feet maximum and no less than 12-gauge., marked with letter "SJOW", and stating, "Suitable for use with outdoor appliances." Using the incorrect cord could lead to the cord overheating, melting and/or a drop in voltage. A drop in voltage can increase preheat times and impact cooking performance and/or cook times.

GRILL COVER

CAUTION: HOT SURFACE! Remove cover before use. **DO NOT** cover when unit is hot.

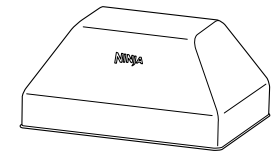

Using the Cover:

- 1 Carefully remove cover from the box.
- 2 Place the cover over the grill with the Ninja logo at the front of the grill. Make sure the side handles and control panel are completely covered.
- 3 Use the bungee cords at the front and back to adjust the fit and hold the cover in place.

Care & Maintenance

- 1 Wipe with damp cloth.
- 2 Use only non-abrasive cleaner such as dish soap and water.

GETTING TO KNOW THE NINJA WOODFIRE™ OUTDOOR GRILL

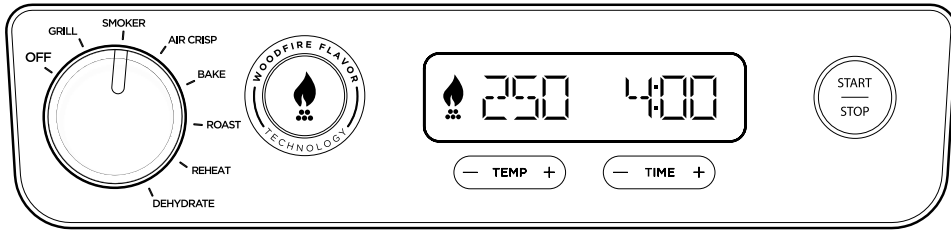

NOTE: Not all functions included with every model.

FUNCTION BUTTONS

GRILL: Closed-hood cooking for top and bottom heat. Best when grilling large or thick cuts of meat or frozen food or for an all-around sear. Open the hood while grilling delicate foods or lean proteins to develop char-grilled textures without overcooking.

SMOKER: Create deep, smoky flavors while cooking low and slow to tenderize large cuts of meat.

AIR CRISP: Achieve crispiness and crunch with little to no oil and higher fan speeds.

BAKE: Bake cakes, treats, desserts, and more with lower fan speeds.

ROAST: Tenderize meats, roast vegetables, and more.

REHEAT: Revive leftovers by gently warming them, leaving you with crispy results.

DEHYDRATE: Dehydrate meats, fruits, and vegetables for healthy snacks.

OPERATING BUTTONS

DIAL: To power on the unit and select a cooking function, rotate the dial clockwise until the dial is pointed to your desired function. To power off the unit, rotate the dial counterclockwise to the **OFF** position.

NOTE: When the unit is powered on, the display will be illuminated.

WOODFIRE FLAVOR TECHNOLOGY: Press after selecting your cooking function to add Woodfire flavor using the Grill, Air Crisp, Bake, Roast, or Dehydrate functions. When pressed, flame icon will illuminate on the display screen.

TEMP: The default temperature setting will display, to adjust temperature if desired, use the – and + buttons next to TEMP.

TIME: To adjust cook time, use the – and + buttons next to TIME.

START/STOP: Press to start or stop the current cook function, or press and hold for 3 seconds to skip preheat.

PREHEAT FOR BETTER RESULTS

For best grilling results, let the grill fully preheat before adding food. Adding food before preheating is complete may lead to overcooking, smoke, and longer preheat time.

After you set function, time, and temperature then press **START**, the unit will automatically begin preheating (except if using the Smoker function or the Dehydrate functions without enabling Woodfire Flavor Technology).

SMOKE BOX

Comes fully installed in the unit. Located on the right side of the hood. Always ensure the removable smoke box is inserted into place before adding pellets. Review all warnings before proceeding.

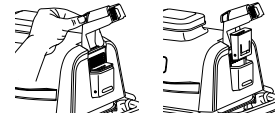

Installing the smoke box:

To install, hold the smoke box lid open with one hand and insert the removable smoke box so it sits into place.

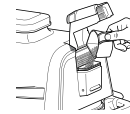

Adding Ninja Woodfire Pellets:

Fill the pellet scoop to the top and level off to avoid spilling. While holding the smoke box lid open, using the pellet scoop, pour pellets into the smoke box until filled to the top. Then, close the smoke box lid.

Use only Ninja Woodfire Pellets for best results, performance and flavor.



Removing the smoke box and cleaning:

To avoid burns allow pellets to completely burn, and smoke box to cool completely, then remove smoke box and safely discard all contents.

COOKING FUNCTIONS

IMPORTANT: Review all warnings at the beginning of this Owner's Guide before proceeding.

NOTE: The Flat Top Griddle Plate is interchangeable with the grill grate for all cook functions except Air Crisp. For more information on using the griddle, see Using the Flat Top Griddle Plate on page 10.

Grill

- Place grill on a flat, level surface.
- Open the hood and install the grill grate by positioning it flat on top of the heating element so it sits into place.
- Install the grease tray by sliding it into place at the back of the grill.
- If you plan to use the Woodfire Flavor Technology, lift the smoke box lid and using the pellet scoop, fill the smoke box with Ninja Woodfire Pellets to the top, then close the lid. **DO NOT** overflow the smoke box.
- Make sure the grill is plugged in and rotate the dial clockwise from the **OFF** position to select the **GRILL** function.
- If adding Woodfire Flavor, press the **WOODFIRE FLAVOR** technology button.
- The default temperature setting will display, to adjust temperature if desired, use the – and + buttons next to **TEMP**.

- To adjust cook time, use the – and + buttons next to **TIME**.
- Press **START** to begin preheating. If using Woodfire Flavor technology, the pellets will go through an ignition cycle (IGN), then the grill will begin preheating (PRE).

NOTE: While preheating is strongly recommended for best results, you can skip it by pressing and holding the **START/STOP** button for 4 seconds. **"ADD FOOD"** will flash across the screen. Open the hood and place ingredients on the grill grate. Once the hood is closed cooking will begin and the timer will start counting down. Skip to step 12 for further instructions.

- When preheating is complete, the unit will beep and **ADD FOOD** will appear on the display.
- Open the hood and place ingredients on the grill grate. Once the hood is closed, cooking will begin and the timer will begin counting down.
- When cook time reaches zero, the grill will beep and **DONE** will appear on the display.
- Remove food from the grill grate.

COOKING FUNCTIONS - CONT'D



IMPORTANT: Review all warnings at the beginning of this Owner's Guide before proceeding.



Smoker

- 1 Place grill on a flat, level surface.
- 2 Open the hood and install the grill grate by positioning it flat on top of the heating element so it sits into place.
- 3 Install the grease tray by sliding it into place at the back of the grill.
- 4 Lift the smoke box lid and using the pellet scoop, fill the smoke box with Ninja Woodfire Pellets to the top, then close the lid. **DO NOT** overflow smoke box.
- 5 Open the hood and place ingredients on the grill grate. Close the hood.
- 6 Make sure the grill is plugged in and rotate the dial clockwise from the **OFF** position to select the **SMOKER** function.
- 7 The default temperature setting will display. To adjust temperature if desired, use the – and + buttons next to **TEMP**.
- 8 To adjust cook time, use the – and + buttons next to **TIME**.
- 9 Press **START** to begin cooking. There is no preheat time for the Smoker function.
- 10 When cook time reaches zero, the grill will beep and **END** will appear on the display.
- 11 Remove food from the grill grate.

Air Crisp



- 1 Place grill on a flat, level surface.
- 2 Open the hood and install the grill grate by positioning it flat on top of the heating element so it sits into place.
- 3 Place the crisper basket on the grill grate and position the basket feet into the designated indentations on the grill grate surface.
- 4 Install the grease tray by sliding it into place at the back of the grill.
- 5  If you plan to use the Woodfire Flavor Technology, lift the smoke box lid and using the pellet scoop, fill the smoke box with Ninja Woodfire Pellets to the top, then close the lid. **DO NOT** overflow the smoke box.
- 6 Make sure the grill is plugged in and rotate the dial clockwise from the **OFF** position to select the **AIR CRISP** function.
- 7  If adding woodfire flavor, press the **WOODFIRE FLAVOR** technology button.
- 8 The default temperature setting will display. To adjust temperature if desired, use the – and + buttons next to **TEMP**.
- 9 To adjust cook time, use the – and + buttons next to **TIME**.
- 10 Press **START** to begin preheating. If using Woodfire Flavor technology, the pellets will go through an ignition cycle (IGN), then the grill will begin preheating (PRE).

NOTE: While preheating is strongly recommended for best results, you can skip it by pressing and holding the **START/STOP** button for 4 seconds. **"ADD FOOD"** will flash across the screen. Open the hood and place ingredients in the crisper basket. Once the hood is closed cooking will begin and the timer will start counting down. Skip to step 13 for further instructions.

- 11 When preheating is complete, the grill will beep and **ADD FOOD** will appear on the display.
- 12 Open the hood and place ingredients on the grill grate. Once the hood is closed, cooking will begin and the timer will begin counting down.
- 13 When cook time reaches zero, the grill will beep and **DONE** will appear on the display.
- 14 Remove food from the crisper basket.

IMPORTANT: Review all warnings at the beginning of this Owner's Guide before proceeding.

Bake (not included on all models)



- 1 Place grill on a flat, level surface.
- 2 Open the hood and install the grill grate by positioning it flat on top of the heating element so it sits into place.
- 3 Install the grease tray by sliding it into place at the back of the grill.
- 4  If you plan to use the Woodfire Flavor Technology, lift the smoke box lid and using the pellet scoop, fill the smoke box with Ninja Woodfire Pellets to the top, then close the lid. **DO NOT** overflow the smoke box.
- 5 Make sure the grill is plugged in and rotate the dial clockwise from the **OFF** position to select the **BAKE** function.
- 6  If adding woodfire flavor, press the **WOODFIRE FLAVOR** technology button.
- 7 The default temperature setting will display. To adjust temperature if desired, use the – and + buttons next to **TEMP**.
- 8 To adjust cook time, use the – and + buttons next to **TIME**.
- 9 Press **START** to begin preheating. If using Woodfire Flavor technology, the pellets will go through an ignition cycle (IGN), then the grill will begin preheating (PRE).

NOTE: While preheating is strongly recommended for best results, you can skip it by pressing and holding the **START/STOP** button for 4 seconds. **"ADD FOOD"** will flash across the screen. Open the hood and place ingredients in the crisper basket. Once the hood is closed cooking will begin and the timer will start counting down. Skip to step 13 for further instructions.

- 10 When preheating is complete, the unit will beep and **ADD FOOD** will appear on the display.
- 11 Open the hood and place ingredients on the grate or place bake pan on the grate. Once the hood is closed, cooking will begin and the timer will start counting down.
- 12 When cook time reaches zero, the grill will beep and **DONE** will appear on the display.
- 13 Remove food from the grill grate.

NOTE: When using the Bake function, make sure to use the proper accessory. For wet or battered ingredients, use a baking dish. For loose items such as cinnamon rolls, hand pies, or biscuits, use the crisper basket.

Roast (not included on all models)

- 1 Place grill on a flat, level surface.
- 2 Open the hood and install the grill grate by positioning it flat on top of the heating element so it sits into place.
- 3 Install the grease tray by sliding it into place at the back of the grill.
- 4  If you plan to use the Woodfire Flavor Technology, lift the smoke box lid and using the pellet scoop, fill the smoke box with Ninja Woodfire Pellets to the top, then close the lid. **DO NOT** overflow the smoke box.
- 5 Make sure the grill is plugged in and rotate the dial clockwise from the **OFF** position to select the **ROAST** function.
- 6  If adding woodfire flavor, press the **WOODFIRE FLAVOR** technology button.
- 7 The default temperature setting will display. To adjust temperature if desired, use the – and + buttons next to **TEMP**.
- 8 To adjust cook time, use the – and + buttons next to **TIME**.
- 9 Press **START** to begin preheating. If using Woodfire Flavor technology, the pellets will go through an ignition cycle (IGN), then the grill will begin preheating (PRE).

NOTE: While preheating is strongly recommended for best results, you can skip it by pressing and holding the **START/STOP** button for 4 seconds. **"ADD FOOD"** will flash across the screen. Open the hood and place ingredients in the crisper basket. Once the hood is closed cooking will begin and the timer will start counting down. Skip to step 12 for further instructions.

- 10 When preheating is complete, the grill will beep and **ADD FOOD** will appear on the display.
- 11 Open the hood and place ingredients on the grill grate. Once the hood is closed, cooking will begin and the timer will begin counting down.
- 12 When cook time reaches zero, the grill will beep and **DONE** will appear on the display.
- 13 Remove food from grill grate.

COOKING FUNCTIONS – CONT'D

IMPORTANT: Review all warnings at the beginning of this Owner's Guide before proceeding.

REHEAT

- 1 Place grill on a flat, level surface.
- 2 If required, place the crisper basket on the grill plate and position the basket feet into the designated indentations on the grill plate surface. Add ingredients, then close the lid.
- 3 Install the grease tray by sliding it into place at the back of the unit.
- 4 Make sure the grill is plugged in and rotate the dial clockwise from the OFF position to select the **REHEAT** function.
- 5 The default temperature setting will display. Use the – and + buttons to choose a temperature from 250°F to 400°F in 10 degree increments.
- 6 Use the – and + buttons next to **TEMP.** to adjust cook time in 1 minute increments up to 1 hour.
- 7 Press **START** to begin cooking (the unit does not preheat in Reheat mode).
- 8 Cooking will begin and the timer will begin counting down.
- 9 When cook time reaches zero, the unit will beep and **DONE** will appear on the display.
- 10 Remove food from the grill grate.

Dehydrate

(not included on all models)

- 1 Place grill on a flat, level surface.
- 2 Open the hood and install the grill grate by positioning it flat on top of the heating element so it sits into place.
- 3 Install the grease tray by sliding it into place at the back of the grill.
- 4 Open the hood and place ingredients on the grill grate. Close the hood. There is no preheat.
- 5 Make sure the unit is plugged in and rotate the dial clockwise from the **OFF** position to select the **DEHYDRATE** function.
- 6 The default temperature setting will display. To adjust temperature if desired, use the – and + buttons next to **TEMP.**
- 7 To adjust cook time, use the – and + buttons next to **TIME.**
- 8 Press **START** to begin cooking.
- 9 When cook time reaches zero, the unit will beep and **DONE** will appear on the display.
- 10 Remove food from the grill grate.



WOODFIRE FLAVOR TECHNOLOGY

- To add Woodfire Flavor, after step 3, lift the smoke box lid and fill the smoke box with Ninja Woodfire Pellets to the top, then close the lid. **DO NOT** overflow smoke box.
- Skip step 4, follow steps 5–7 for programming. *Press the **WOODFIRE FLAVOR** button after you select **DEHYDRATE** in step 4.
- After step 7, press **START** to begin preheating. The pellets will go through an ignition cycle (IGN).
- When preheating is complete, the grill will beep and **ADD FOOD** will appear on the display.
- Open the hood and place ingredients on the grill grate. Once the hood is closed, cooking will begin and the timer will begin counting down.
- When cook time reaches zero, the grill will beep and **DONE** will appear on the display.
- Remove food from the grill grate.



Using the Flat Top Griddle Plate:

- 1 Carefully remove griddle from the box. Before using, hand-wash with warm, soapy water.
- 2 Place the griddle on the heating element. **DO NOT** place the griddle on the grill grate.
- 3 Install the grease tray by sliding it into place at the back of the grill.
- 4 Select a cook function and temperature/ time, then let the unit preheat to the selected temperature. Once the unit is preheated, place ingredients on the griddle.

NOTE: There is no preheat for the Smoker, and Dehydrate functions.

⚠ WARNING: HOT SURFACE

NOTE: The griddle is **NOT** dishwasher safe.

The griddle becomes extremely hot during the cooking process. **DO NOT** touch hot surfaces during or immediately after cooking. **ALWAYS** avoid direct physical contact. To prevent burns or personal injury, **ALWAYS** use care when using the product. Use long-handed utensils and protective hot pads or insulated oven mitts. Place griddle on a heat-resistant surface after removing.

NOTE: Use non-metallic utensils (such as silicone-tipped tongs, long-handled spoons, spatulas, etc.) to handle and turn foods.

CLEANING YOUR NINJA WOODFIRE™ OUTDOOR GRILL

The grill should be cleaned thoroughly after each use. **ALWAYS** let the appliance and accessories cool before cleaning.

- Unplug the grill from power source before cleaning. Keep the hood open after removing your food to allow the unit to cool quicker.
- Remove smoke box and safely discard all contents after every use.
- The pellet scoop is dishwasher safe. The grill grate, flat top griddle plate, crisper basket, grease tray, and smoke box are not dishwasher safe.
- Carefully remove cooled grease tray from back of unit and safely discard grease contents after each use. Hand-wash grease tray in warm, soapy water.

- Cleaning of the smoke box is not required. However if desired, a wire brush can be used to remove extra creosote.

NOTE: DO NOT use liquid cleaning solution on the smoke box.

- The inner hood should be wiped down with a damp towel or cloth after each use to deodorize the unit and remove any grease.
- If food residue or grease is stuck on the grill grate or any other removable part, soak in warm, soapy water before cleaning.
- Remove non-stick grill grate, non-stick flat top griddle plate, and non-stick crisper basket (if used) after each use and hand-wash with warm, soapy water.
- Gently wipe down the inside of the hood with

NOTE: NEVER use abrasive tools or cleaners. **NEVER** immerse the main unit in water or any other liquid. **DO NOT** place in dishwasher.

a damp cloth.

- When stacking the coated accessories to store, place a cloth or paper towel between each piece to protect the coated surfaces.

TROUBLESHOOTING GUIDE

⚠ WARNING: To reduce the risk of shock and unintended operation, turn power off and unplug unit before troubleshooting.

- **“Add Food” appears on the control panel display.**
The unit has completed preheating and it is now time to add your ingredients.
- **“Shut Lid” appears on the control panel display.**
The hood is open and needs to be close for the selected function to start.
- **“Add Grill” appears on the control panel.**
The grill grate needs to be installed. Once installed, closed the hood and press the Start button to begin.
- **“E” appears on the control panel display.**
The unit is not functioning properly. Contact Customer Service at 1- 855-427-5125. So we may better assist you, please register your product online at registryourninja.com and have the product on hand when you call.
- **Should I add my ingredients before or after preheating?**
For best results, let the unit preheat before adding ingredients.
- **Why did a circuit breaker trip while using the unit?**
The unit uses 1760 watts of power, so it must be plugged into an outlet on a 15-amp circuit breaker. Using an outlet on a 10-amp breaker will cause the breaker to trip. It is also important that the unit be the only appliance plugged into an outlet when in use. To avoid tripping a breaker, make sure the unit is the only appliance plugged into an outlet on a 15-amp breaker.
- **Do I need to completely fill the smoke box with pellets?**
Yes, always fill the smoke box to the top. We've perfected the amount of pellets needed for each smoke session, regardless of the function or food load, the unit will burn through them appropriately.
- **When do I press the Woodfire Flavor Technology Button?**
Press the Woodfire Flavor Technology button before pressing start when wanting to add smoke using the Grill, Air Crisp, Roast, Bake, or Dehydrate functions. You do not need to press the Woodfire Flavor Technology button when using the Smoker function.
- **Where should I keep my pellets stored?**
Always store pellets in a dry area. Any moisture in the pellets can compromise ignition and quality of smoke flavor.
- **Should I use any oils or non-stick sprays when smoking?**
No, we do not recommend using any oils or non-stick sprays when smoking because smoke will not adhere to the food as well.
- **How do I dispose of burnt pellets after a cook cycle?**
Pellets may continue to burn after cook time is complete. Do not touch or remove the smoke box until the grill has stopped smoking, pellets have completely burnt out, and the smoke box has cooled. Then, remove the smoke box and safely discard all contents.
- **Why is preheat taking so long?**
Preheat times vary by function and unit temperature.
GRILL: approx. 12-20 minutes.
AIR CRISP, BAKE, ROAST: 3 minutes
SMOKER, DEHYDRATE: No preheat.

If you are not using Woodfire Flavor Technology, preheat times will be 5-7 minutes faster.

Using the unit in inclement weather with heavy rain could cause longer preheat times.

We recommend using only extension cords marked with letters “SJOW” and stating, “Suitable for use with outdoor appliances.” Longer cord length may also cause longer preheat times, we recommend using the shortest outdoor rated extension cord that fits your outdoor grill set up.

While preheating is strongly recommended for best results, you can skip it by pressing and holding the START/STOP button for 4 seconds. “ADD FOOD” will flash across the screen. Open the hood and place ingredients in unit. Once the hood is closed, cooking will begin and the timer will start counting down.

TROUBLESHOOTING GUIDE

- **Can I turn off Woodfire Flavor Technology?**
If you pressed Woodfire Flavor Technology and already started your cooking function by pressing START, you can press the Woodfire Flavor Technology button again to turn it off if the ignition cycle is less than 75% complete (indicated by the progress bar on the display screen). If pellets have fully ignited and the grill has transitioned to the preheat cycle (indicated on the display screen), you cannot turn Woodfire Flavor Technology off.
- **Can I add more pellets during a cook cycle?**
When using the SMOKER function, you can add more pellets once the first batch has fully burned. Press and hold the Woodfire Flavor Technology button for 3 seconds to ignite new full box of pellets

Run back to back smoking sessions, we recommend re-filling the smoke box using the pellet scoop when half the pellets have burned. DO NOT re-fill more than 1 or 2 times. DO NOT re-ignite pellets.

REPLACEMENT PARTS

To order additional parts and accessories, visit ninjaaccessories.com or contact Customer Service at **1-855-427-5125**. We ask that you register your product online at registryourninja.com and have the product on hand when you call, so we may better assist you.

THANK YOU for purchasing the NINJA WOODFIRE™ Outdoor Grill



REGISTER YOUR PURCHASE



registeryourninja.com



Scan QR code using mobile device

TECHNICAL SPECIFICATIONS

Voltage: 120V~, 60Hz

Power: 1760 Watts

RECORD THIS INFORMATION

Model Number: _____

Serial Number: _____

Date of Purchase: _____

(Keep receipt)

Store of Purchase: _____

SharkNinja Operating LLC
US: Needham, MA 02494
1-855-427-5125
ninjakitchen.com

Illustrations may differ from actual product. We are constantly striving to improve our products, therefore the specifications contained herein are subject to change without notice.

NINJA is a registered trademark of SharkNinja Operating LLC.

NINJA WOODFIRE is a trademark of SharkNinja Operating LLC.

This product may be covered by one or more U.S. patents. See sharkninja.com/patents for more information.

© 2022 SharkNinja Operating LLC

OG705A_IB_MP_Mv4



@ninjakitchen